

---

European Organisation for Technical Approvals  
Europäische Organisation für Technische Zulassungen  
Organisation Européenne pour l'Agrément Technique

---

**ETAG 001**

Edition 1997

GUIDELINE FOR EUROPEAN TECHNICAL APPROVAL  
OF  
**METAL ANCHORS**  
**FOR USE IN CONCRETE**

**Annex C: DESIGN METHODS FOR ANCHORAGES**

**Amended October 2001**

**2<sup>nd</sup> Amendment November 2006**

**3<sup>rd</sup> Amendment August 2010**

EOTA<sup>©</sup>  
Avenue des Arts 40  
Kunstlaan,  
1040 Brussels

**TABLE OF CONTENTS**  
**ANNEX C Design methods for anchorages**

Introduction.....	3
1 Scope .....	3
1.1 Type of anchors, anchor groups and number of anchors.....	3
1.2 Concrete member.....	4
1.3 Type and direction of load .....	4
1.4 Classification of the consequence of failure.....	4
2 Terminology and Symbols .....	5
2.1 Indices.....	5
2.2 Actions and resistances.....	5
2.3 Concrete and steel .....	5
2.4 Characteristic values of anchors (see Figure 2.1).....	6
3 Design and safety concept.....	7
3.1 General .....	7
3.2 Ultimate limit state .....	7
3.2.1 Design resistance .....	7
3.2.2 Partial safety factors for resistances.....	7
3.2.2.1 Concrete cone failure, splitting failure, pull-out failure, pry-out failure and concrete edge failure.....	7
3.2.2.2 Steel failure.....	8
3.3 Serviceability limit state .....	8
4 Static analysis.....	8
4.1 Non-cracked and cracked concrete .....	8
4.2 Loads acting on anchors .....	8
4.2.1 Tension loads .....	9
4.2.2 Shear loads .....	10
4.2.2.1 Distribution of loads .....	10
4.2.2.2 Determination of shear loads .....	12
4.2.2.3 Shear loads without lever arm.....	14
4.2.2.4 Shear loads with lever arm.....	15
5 Ultimate limit state .....	16
5.1 General .....	16
5.2 Design method A.....	17
5.2.1 General .....	17
5.2.2 Resistance to tension loads.....	17
5.2.2.1 Required proofs .....	17
5.2.2.2 Steel failure.....	17
5.2.2.3 Pull-out failure.....	17
5.2.2.4 Concrete cone failure.....	17
5.2.2.5 Splitting failure due to anchor installation.....	21
5.2.2.6 Splitting failure due to loading.....	21
5.2.3 Resistance to shear loads .....	22
5.2.3.1 Required proofs .....	22
5.2.3.2 Steel failure.....	22
5.2.3.3 Concrete pry-out failure .....	23
5.2.3.4 Concrete edge failure.....	24
5.2.4 Resistance to combined tension and shear loads.....	30
5.3 Design method B.....	31
5.4 Design method C.....	32
6 Serviceability limit state.....	32
6.1 Displacements.....	32
6.2 Shear load with changing sign.....	32
7 Additional proofs for ensuring the characteristic resistance of concrete member.....	32
7.1 General .....	32
7.2 Shear resistance of concrete member .....	33
7.3 Resistance to splitting forces.....	34

## Introduction

The design methods for anchorages are intended to be used for the design of anchorages under due consideration of the safety and design concept within the scope of the European Technical Approvals (ETA) of anchors.

The design methods given in Annex C are based on the assumption that the required tests for assessing the admissible service conditions given in Part 1 and the subsequent Parts have been carried out. Therefore Annex C is a pre-condition for assessing and judging of anchors. The use of other design methods will require reconsideration of the necessary tests.

The ETA's for anchors give the characteristic values only of the different approved anchors. The design of the anchorages (e.g. arrangement of anchors in a group of anchors, effect of edges or corners of the concrete member on the characteristic resistance) shall be carried out according to the design methods described in Chapter 3 to 5 taking account of the corresponding characteristic values of the anchors.

Chapter 7 gives additional proofs for ensuring the characteristic resistance of the concrete member which are valid for all anchor systems.

The design methods are valid for all anchor types. However, the equations given in the following are valid for anchors according to current experience only (see Annex B). If values for the characteristic resistance, spacings, edge distances differ between the design methods and the ETA, the value given in the ETA governs. In the absence of national regulations the partial safety factors given in the following may be used.

## 1 Scope

### 1.1 Type of anchors, anchor groups and number of anchors

The design methods apply to the design of anchorages in concrete using approved anchors which fulfil the requirements of this Guideline. The characteristic values of these anchors are given in the relevant ETA.

The design methods are valid for single anchors and anchor groups. In case of an anchor group the loads are applied to the individual anchors of the group by means of a rigid fixture. In an anchor group only anchors of the same type, size and length shall be used.

The design methods cover single anchors and anchor groups according to Figure 1.1 and 1.2. Other anchor arrangements e.g. in a triangular or circular pattern are also allowed; however, the provisions of this design method should be applied with engineering judgement.

In general this design method is valid only if the diameter  $d_f$  of the clearance hole in the fixture is not larger than the value according to Table 4.1.

Exceptions:

- For fastenings loaded in tension only a larger diameter of the clearance hole is acceptable if a corresponding washer is used.
- For fastenings loaded in shear or combined tension and shear if the gap between the hole and the fixture is filled with mortar of sufficient compression strength or eliminated by other suitable means.

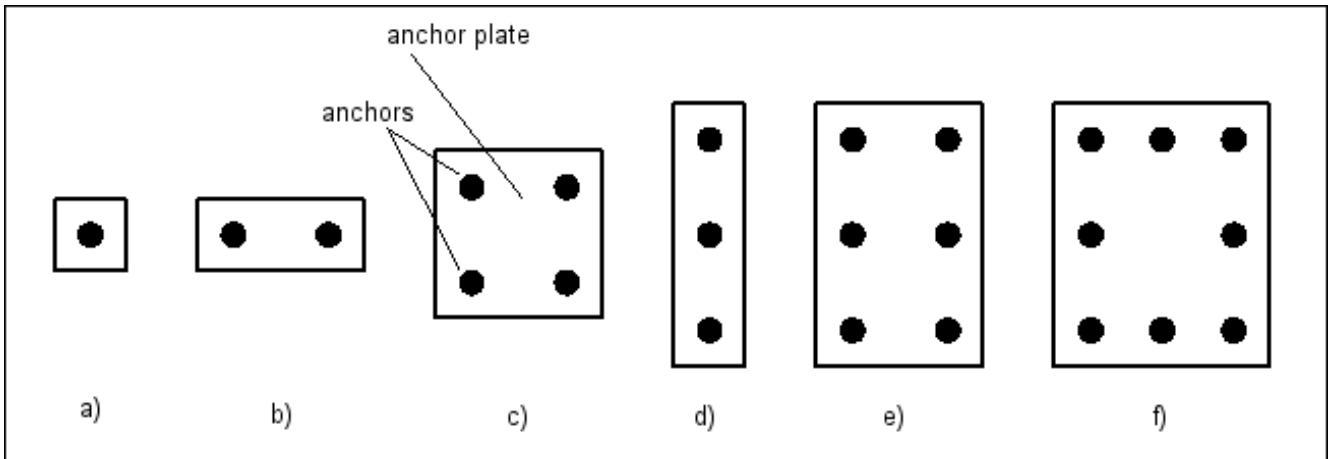

**Figure 1.1** Anchorages covered by the design methods

- all loading directions, if anchors are situated far from edges ( $c \geq \max(10 h_{ef}, 60 d)$ )
- tension loading only, if anchors are situated close to edges ( $c < \max(10 h_{ef}, 60 d)$ )

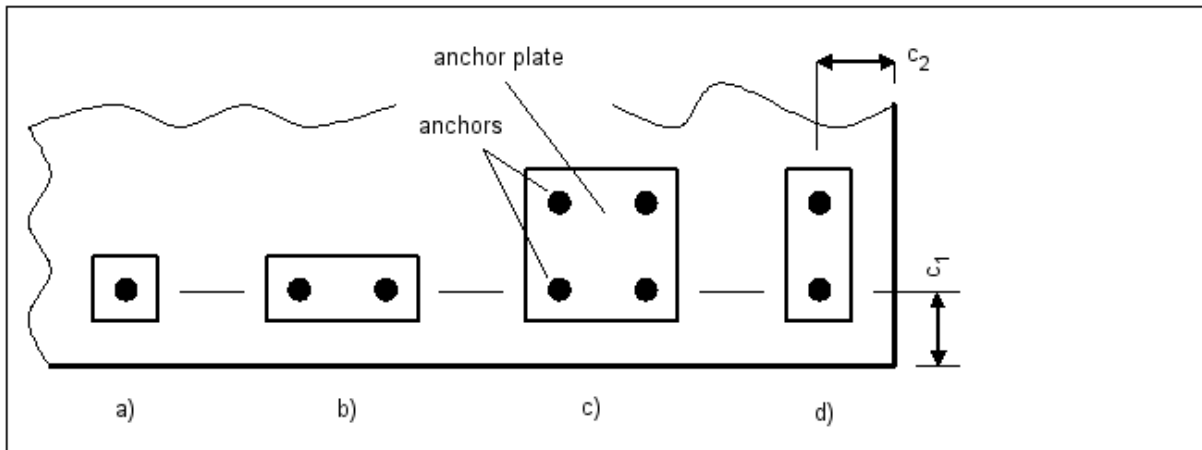

**Figure 1.2** Anchorages covered by the design methods  
Shear loading, if anchors are situated close to an edge ( $c < \max(10 h_{ef}, 60 d)$ )

## 1.2 Concrete member

The concrete member shall be of normal weight concrete of at least strength class C20/25 and at most strength class C50/60 to EN 206 [8] and shall be subjected only to predominantly static loads. The concrete may be cracked or non-cracked. In general for simplification it is assumed that the concrete is cracked; otherwise it shall be shown that the concrete is non-cracked (see 4.1).

## 1.3 Type and direction of load

The design methods apply to anchors subjected to static or quasi-static loadings and not to anchors subjected to impact or seismic loadings or loaded in compression.

## 1.4 Classification of the consequence of failure

Anchorage carried out in accordance with these design methods are considered to belong to anchorages, the failure of which would comprise the stability of works, cause risk to human life and/or lead to considerable economic consequences.

## 2 Terminology and Symbols

The notations and symbols frequently used in the design methods are given below. Further notations are given in the text.

### 2.1 Indices

S	=	action
R	=	resistance
M	=	material
k	=	characteristic value
d	=	design value
s	=	steel
c	=	concrete
cp	=	concrete pry-out
p	=	pull-out
sp	=	splitting
u	=	ultimate
y	=	yield

### 2.2 Actions and resistances

F	=	force in general (resulting force)
N	=	normal force (positive: tension force, negative: compression force)
V	=	shear force
M	=	moment
$F_{Sk} (N_{Sk}; V_{Sk}; M_{Sk}; M_{T,Sk})$	=	characteristic value of actions acting on a single anchor or the fixture of an anchor group (normal load, shear load, bending moment, torsion moment)
$F_{Sd} (N_{Sd}; V_{Sd}; M_{Sd}, M_{T,Sd})$	=	design value of actions
$N_{Sd}^h (V_{Sd}^h)$	=	design value of tensile load (shear load) acting on the most stressed anchor of an anchor group calculated according to 4.2
$N_{Sd}^g (V_{Sd}^g)$	=	design value of the sum (resultant) of the tensile (shear) loads acting on the tensioned (sheared) anchors of a group calculated according to 4.2
$F_{Rk} (N_{Rk}; V_{Rk})$	=	characteristic value of resistance of a single anchor or an anchor group respectively (normal force, shear force)
$F_{Rd} (N_{Rd}; V_{Rd})$	=	design value of resistance

### 2.3 Concrete and steel

$f_{ck,cube}$	=	characteristic concrete compression strength measured on cubes with a side length of 150 mm (value of concrete strength class according to EN 206 [8])
$f_{yk}$	=	characteristic steel yield strength (nominal value)
$f_{uk}$	=	characteristic steel ultimate tensile strength (nominal value)
$A_s$	=	stressed cross section of steel
$W_{el}$	=	elastic section modulus calculated from the stressed cross section of steel ( $\frac{\pi d^3}{32}$ for a round section with diameter d)

## 2.4 Characteristic values of anchors (see Figure 2.1)

$a$	=	spacing between outer anchors of adjoining groups or between single anchors
$a_1$	=	spacing between outer anchors of adjoining groups or between single anchors in direction 1
$a_2$	=	spacing between outer anchors of adjoining groups or between single anchors in direction 2
$b$	=	width of concrete member
$c$	=	edge distance
$c_1$	=	edge distance in direction 1; in case of anchorages close to an edge loaded in shear $c_1$ is the edge distance in direction of the shear load (see Figure 2.1b and Figure 5.7)
$c_2$	=	edge distance in direction 2; direction 2 is perpendicular to direction 1
$c_{cr}$	=	edge distance for ensuring the transmission of the characteristic resistance (design methods B and C)
$c_{cr,N}$	=	edge distance for ensuring the transmission of the characteristic tensile resistance of a single anchor without spacing and edge effects in case of concrete cone failure (design method A)
$c_{cr,sp}$	=	edge distance for ensuring the transmission of the characteristic tensile resistance of a single anchor without spacing and edge effects in case of splitting failure (design method A)
$c_{min}$	=	minimum allowable edge distance
$d$	=	diameter of anchor bolt or thread diameter
$d_{nom}$	=	outside diameter of anchor
$d_o$	=	drill hole diameter
$h$	=	thickness of concrete member
$h_{ef}$	=	effective anchorage depth
$h_{min}$	=	minimum thickness of concrete member
$l_f$	=	effective length of anchor under shear loading. For bolts of uniform cross-section over their lengths the value of $h_{ef}$ has to be used as effective anchorage depth, and for anchors with several sleeves and throats of cross-section, for example, only the length from the concrete surface up to the relevant sleeve would govern.
$s$	=	spacing of anchors in a group
$s_1$	=	spacing of anchors in a group in direction 1
$s_2$	=	spacing of anchors in a group in direction 2
$s_{cr}$	=	spacing for ensuring the transmission of the characteristic resistance (design methods B and C)
$s_{cr,N}$	=	spacing for ensuring the transmission of the characteristic tensile resistance of a single anchor without spacing and edge effects in case of concrete cone failure (design method A)
$s_{cr,sp}$	=	spacing for ensuring the transmission of the characteristic tensile resistance of a single anchor without spacing and edge effects in case of splitting failure (design method A)
$s_{min}$	=	minimum allowable spacing

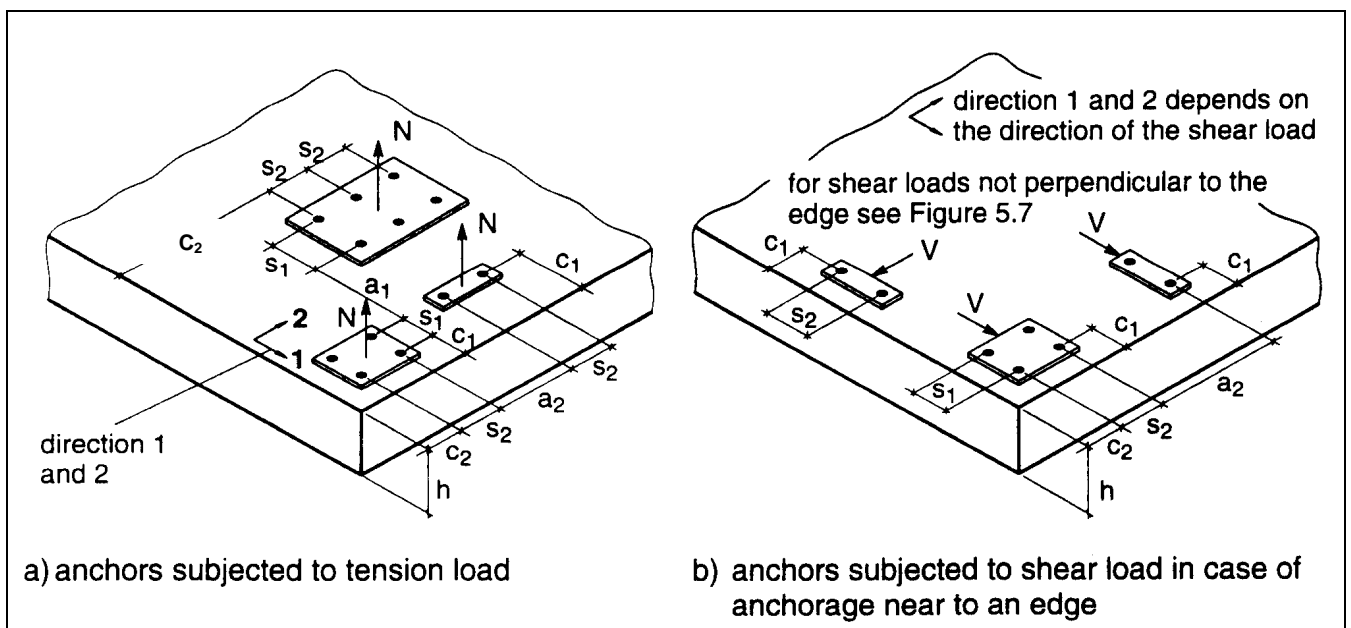

**Figure 2.1** Concrete member, anchor spacing and edge distance

### 3 Design and safety concept

#### 3.1 General

The design of anchorages shall be in accordance with the general rules given in EN 1990. It shall be shown that the value of the design actions  $S_d$  does not exceed the value of the design resistance  $R_d$ .

$$S_d \leq R_d \quad (3.1)$$

$S_d$  = value of design action  
 $R_d$  = value of design resistance

Actions to be used in design may be obtained either from a published National Annex to EN 1991 or, in its absence, to national regulations or, in their absence, to EN 1991 itself.

The partial safety factors for actions may be taken either from a published National Annex to EN 1991 or, in its absence, to national regulations or, in their absence, to EN 1991 itself.

The design resistance is calculated as follows:

$$R_d = R_k / \gamma_M \quad (3.2)$$

$R_k$  = characteristic resistance of a single anchor or an anchor group  
 $\gamma_M$  = partial safety factor for material

#### 3.2 Ultimate limit state

##### 3.2.1 Design resistance

The design resistance is calculated according to Equation (3.2). In design method A the characteristic resistance is calculated for all load directions and failure modes.

In design methods B and C only one characteristic resistance is given for all load directions and failure modes.

##### 3.2.2 Partial safety factors for resistances

In the absence of national regulations the following partial safety factors may be used. However, the value of  $\gamma_2$  may not be changed because it describes a characteristic of the anchors.

##### 3.2.2.1 Concrete cone failure, splitting failure, pull-out failure, pry-out failure and concrete edge failure

The partial safety factors for concrete cone failure, pry-out failure and concrete edge failure ( $\gamma_{Mc}$ ), splitting failure ( $\gamma_{Msp}$ ) and pull-out failure ( $\gamma_{Mp}$ ) are given in the relevant ETA.

*For anchors to according current experience the partial safety factor  $\gamma_{Mc}$  is determined from:*

$$\begin{aligned} \gamma_{Mc} &= \gamma_c \cdot \gamma_2 \\ \gamma_c &= \text{partial safety factor for concrete} = 1.5 \end{aligned}$$

$\gamma_2$  = partial safety factor taking account of the installation safety of an anchor system  
*The partial safety factor  $\gamma_2$  is evaluated from the results of the installation safety tests; see Part 1, 6.1.2.2.2.*

*Tension loading*

$$\begin{aligned} \gamma_2 &= 1.0 \text{ for systems with high installation safety} \\ &= 1.2 \text{ for systems with normal installation safety} \\ &= 1.4 \text{ for systems with low but still acceptable installation safety} \end{aligned}$$

*Shear loading (concrete pry-out failure, concrete edge failure)*

$$\gamma_2 = 1.0$$

*For the partial safety factors  $\gamma_{Msp}$  and  $\gamma_{Mp}$  the value for  $\gamma_{Mc}$  may be taken.*

### 3.2.2.2 Steel failure

The partial safety factors  $\gamma_{Ms}$  for steel failure are given in the relevant ETA.

*For anchors according to current experience the partial safety factors  $\gamma_{Ms}$  are determined as a function of the type of loading as follows:*

*Tension loading:*

$$\gamma_{Ms} = \frac{1.2}{f_{yk}/f_{uk}} \geq 1.4 \quad (3.3a)$$

*Shear loading of the anchor with and without lever arm:*

$$\gamma_{Ms} = \frac{1.0}{f_{yk}/f_{uk}} \geq 1.25 \quad f_{uk} \leq 800 \text{ N/mm}^2 \quad (3.3b)$$

$$\text{and } f_{yk}/f_{uk} \leq 0.8$$

$$\gamma_{Ms} = 1.5 \quad \begin{array}{l} f_{uk} > 800 \text{ N/mm}^2 \\ \text{or } f_{yk}/f_{uk} > 0.8 \end{array} \quad (3.3c)$$

### 3.3 Serviceability limit state

In the serviceability limit state it shall be shown that the displacements occurring under the characteristic actions are not larger than the admissible displacement. For the characteristic displacements see 6. The admissible displacement depends on the application in question and should be evaluated by the designer.

In this check the partial safety factors on actions and on resistances may be assumed to be equal to 1.0.

## 4 Static analysis

### 4.1 Non-cracked and cracked concrete

If the condition in Equation (4.1) is not fulfilled or not checked, then cracked concrete shall be assumed.

Non-cracked concrete may be assumed in special cases if in each case it is proved that under service conditions the anchor with its entire anchorage depth is located in non-cracked concrete. In the absence of other guidance the following provisions may be taken.

For anchorages subjected to a resultant load  $F_{Sk} \leq 60 \text{ kN}$  non-cracked concrete may be assumed if Equation (4.1) is observed:

$$\sigma_L + \sigma_R \leq 0 \quad (4.1)$$

$\sigma_L$  = stresses in the concrete induced by external loads, including anchors loads  
 $\sigma_R$  = stresses in the concrete due to restraint of intrinsic imposed deformations (e.g. shrinkage of concrete) or extrinsic imposed deformations (e.g. due to displacement of support or temperature variations). If no detailed analysis is conducted, then  $\sigma_R = 3 \text{ N/mm}^2$  should be assumed, according to EC 2 [1].

The stresses  $\sigma_L$  and  $\sigma_R$  are calculated assuming that the concrete is non-cracked (state I). For plane concrete members which transmit loads in two directions (e.g. slabs, walls) Equation (4.1) shall be fulfilled for both directions.

### 4.2 Loads acting on anchors

In the static analysis the loads and moments are given which are acting on the fixture. To design the anchorage the loads acting on each anchor shall be calculated, taking into account partial safety factors for actions according to 3.1 in the ultimate limit state and according to 3.3 in the serviceability limit state.

With single anchors normally the loads acting on the anchor are equal to the loads acting on the fixture. With anchor groups the loads, bending and torsion moments acting on the fixture are distributed to tension and shear forces acting on the individual anchors of the group. This distribution shall be calculated according to the theory of elasticity.



#### 4.2.1 Tension loads

In general, the tension loads acting on each anchor due to loads and bending moments acting on the fixture shall be calculated according to the theory of elasticity using the following assumptions:

- The anchor plate does not deform under the design actions. To ensure the validity of this assumption the anchor plate shall be sufficiently stiff.
- The stiffness of all anchors is equal and corresponds to the modulus of elasticity of the steel. The modulus of elasticity of concrete is given in [1]. As a simplification it may be taken as  $E_c = 30\,000 \text{ N/mm}^2$ .
- In the zone of compression under the fixture the anchors do not contribute to the transmission of normal forces (see Figure 4.1b).

If in special cases the anchor plate is not sufficiently stiff, then the flexibility of the anchor plate shall be taken into account when calculating loads acting on the anchors.

In the case of anchor groups with different levels of tension forces  $N_{si}$  acting on the individual anchors of a group the eccentricity  $e_N$  of the tension force  $N_S^g$  of the group may be calculated (see Figure 4.1), to enable a more accurate assessment of the anchor group resistance.

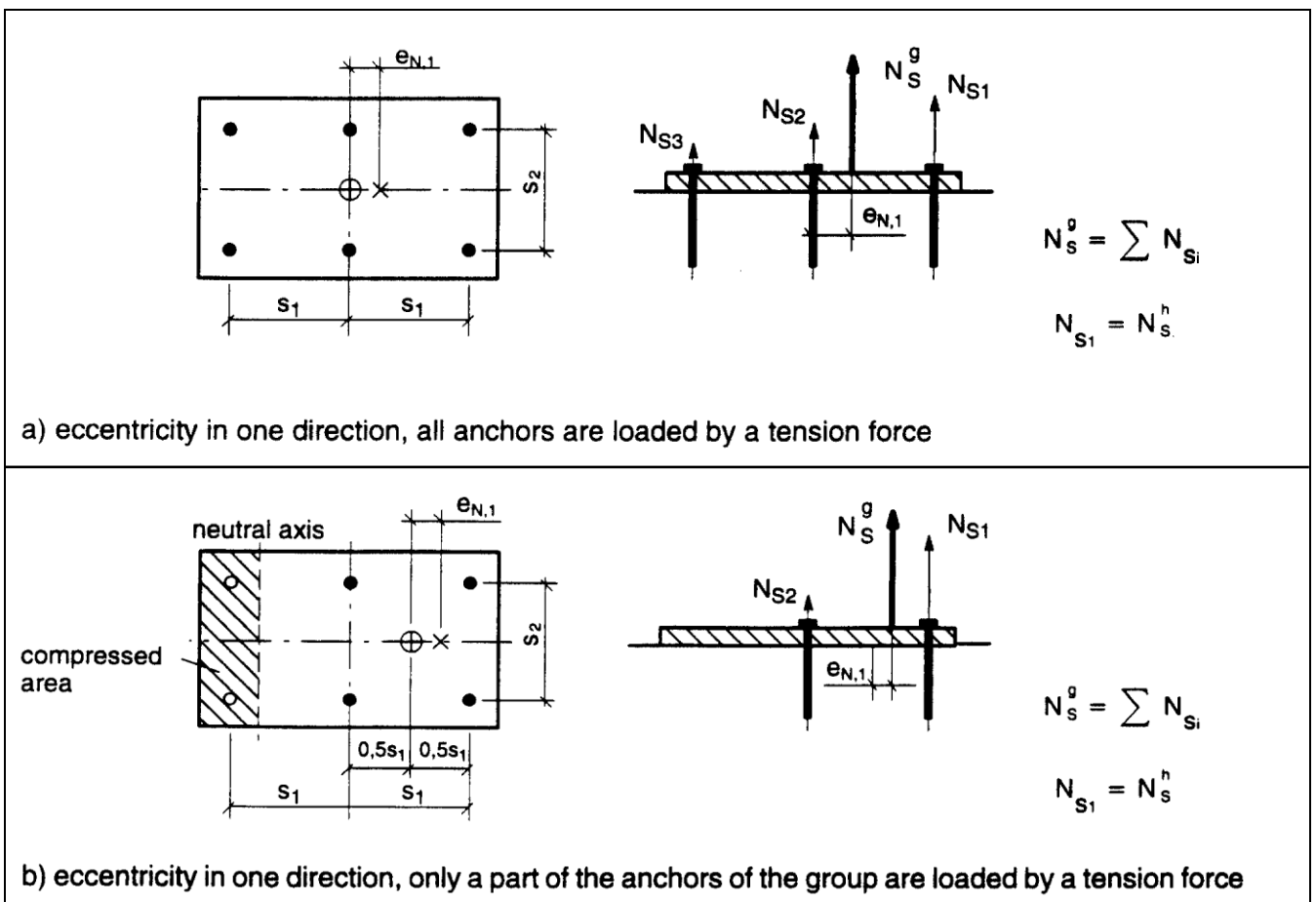

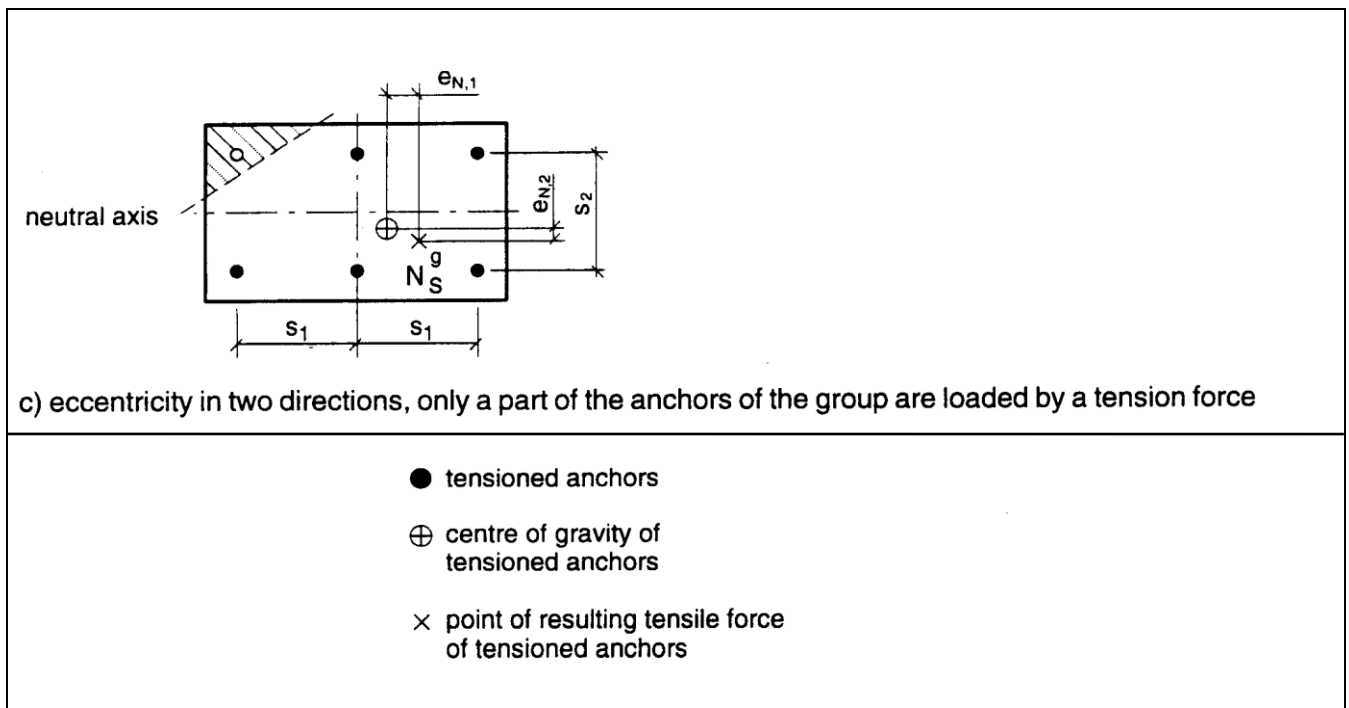

**Figure 4.1** Example of anchorages subjected to an eccentric tensile load  $N_S^g$

If the tensioned anchors do not form a rectangular pattern, for reasons of simplicity the group of tensioned anchors may be resolved into a group rectangular in shape (that means the centre of gravity of the tensioned anchors may be assumed in the centre of the axis in Figure 4.1c).

## 4.2.2 Shear loads

### 4.2.2.1 Distribution of loads

The distribution of shear loads depends on the mode of failure:

a) Steel failure and concrete pry-out failure

It is assumed that all anchors of a group take up shear loads if the diameter  $d_f$  of the clearance hole in the fixture is not larger than the value given in Table 4.1 (see Figures 4.2 and 4.6)

b) Concrete edge failure

Only the most unfavourable anchors take up shear loads if the shear acts perpendicular towards the edge (see Figures 4.3 and 4.7). All anchors take up shear loads acting parallel to the edge.

Slotted holes in the direction of shear load prevent anchors to take up shear loads. This can be favourable in case of fastenings close to an edge (see Figure 4.4)

If the diameter  $d_f$  of the clearance hole is larger than given in Table 4.1 the design method is only valid if the gap between the bolt and the fixture is filled with mortar of sufficient compression strength or eliminated by other suitable means.

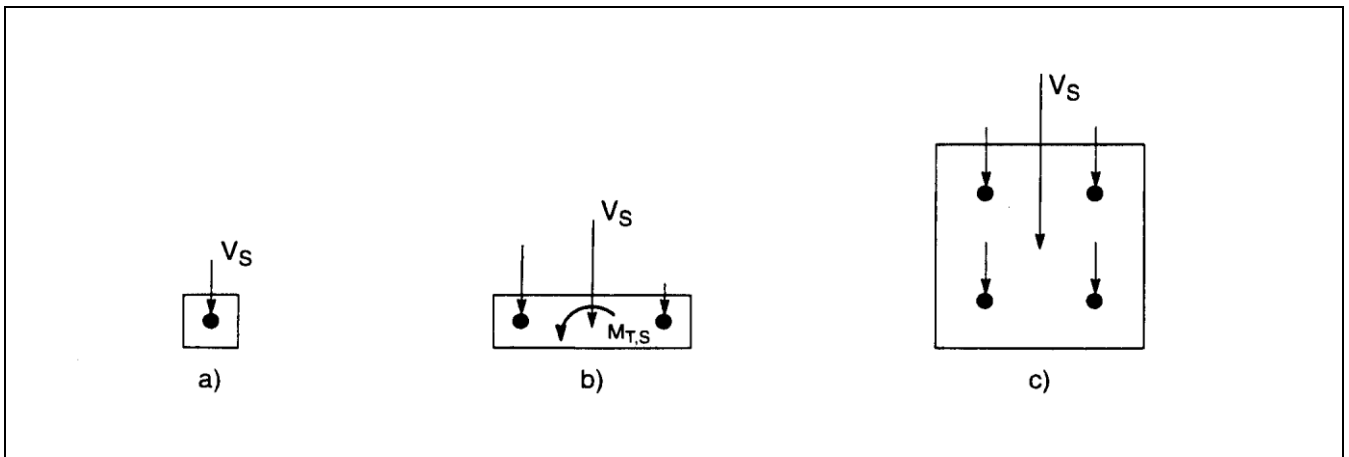

**Figure 4.2** Examples of load distribution, when all anchors take up shear loads

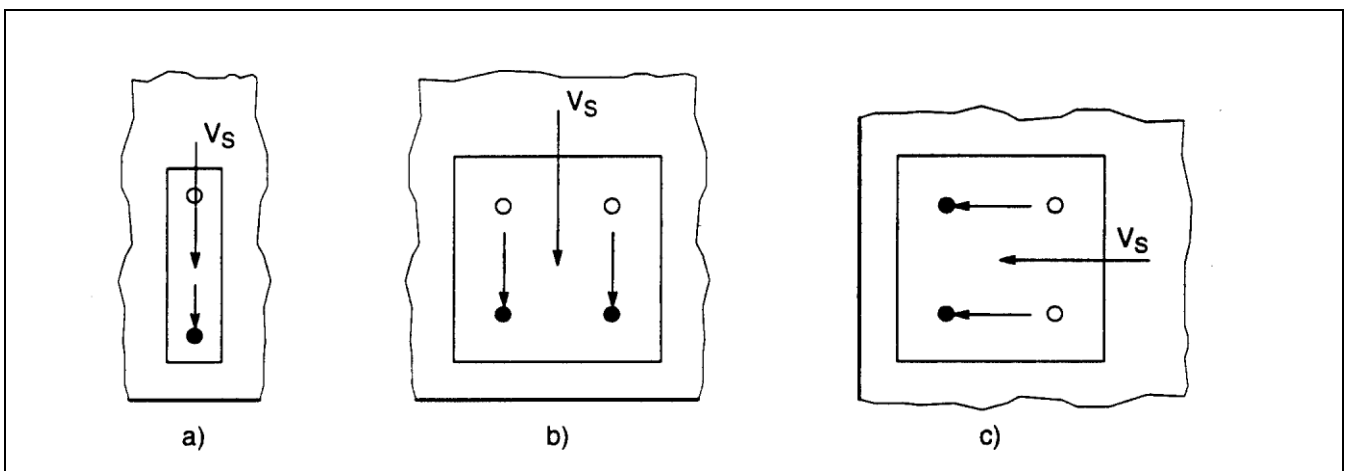

**Figure 4.3** Examples of load distribution when only the most unfavorable anchors take up shear loads

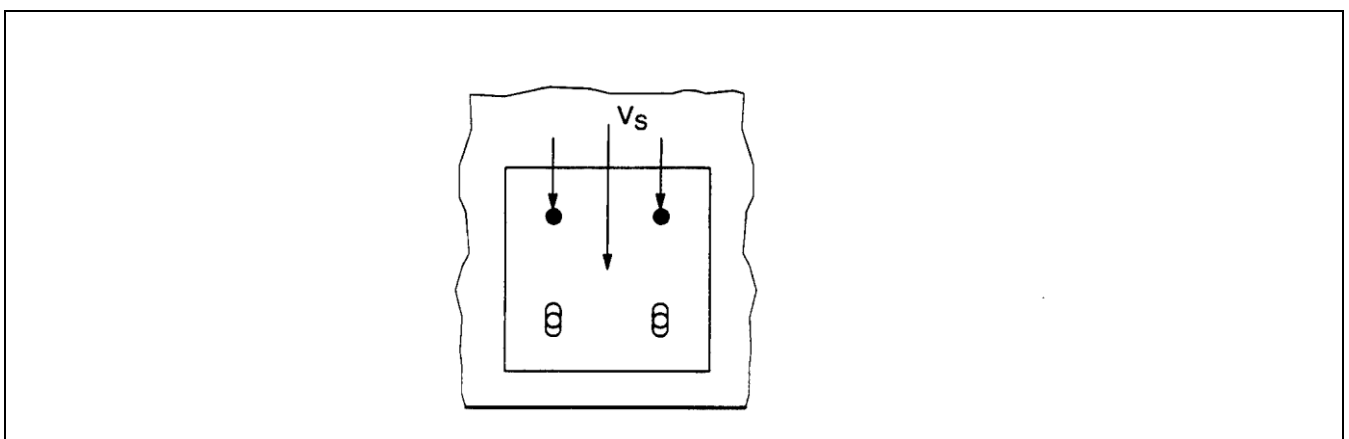
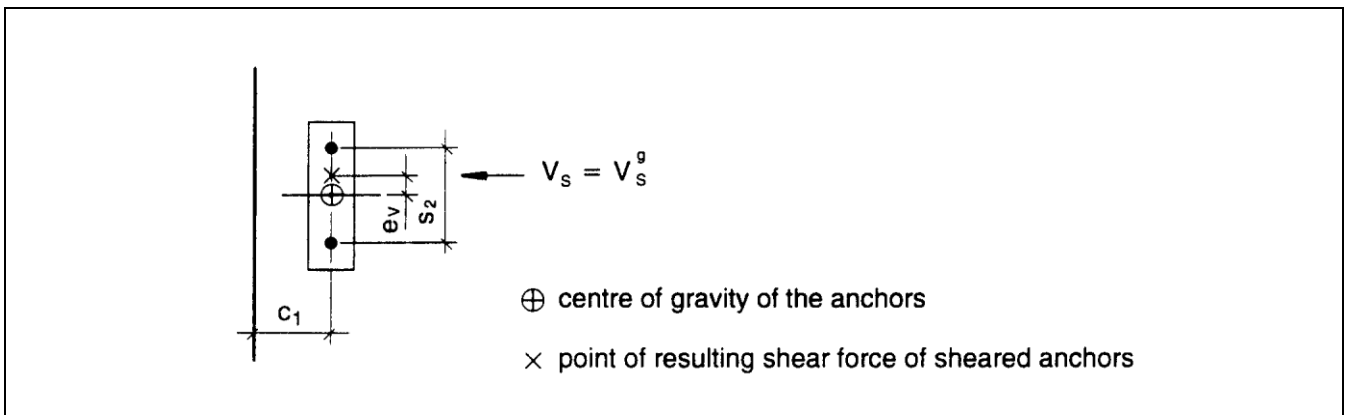

**Figure 4.4** Examples of load distribution for an anchorage with slotted holes

**Table 4.1** Diameter of clearance hole in the fixture

external diameter $d^{1)} \text{ or } d_{\text{nom}}^{2)}$ (mm)	6	8	10	12	14	16	18	20	22	24	27	30
diameter $d_f$ of clearance hole in the fixture (mm)	7	9	12	14	16	18	20	22	24	26	30	33
<sup>1)</sup> if bolt bears against the fixture <sup>2)</sup> if sleeve bears against the fixture												

In the case of anchor groups with different levels of shear forces  $V_{si}$  acting on the individual anchors of the group the eccentricity  $e_v$  of the shear force  $V_s^g$  of the group may be calculated (see Figure 4.5), to enable a more accurate assessment of the anchor group resistance.

**Figure 4.5** Example of an anchorage subjected to an eccentric shear load

#### 4.2.2.2 Determination of shear loads

The determination of shear loads to the fasteners in a group resulting from shear forces and torsion moments acting on the fixture is calculated according to the theory of elasticity assuming equal stiffness for all fasteners of a group. Equilibrium has to be satisfied. Examples are given in Figures 4.6 and 4.7.

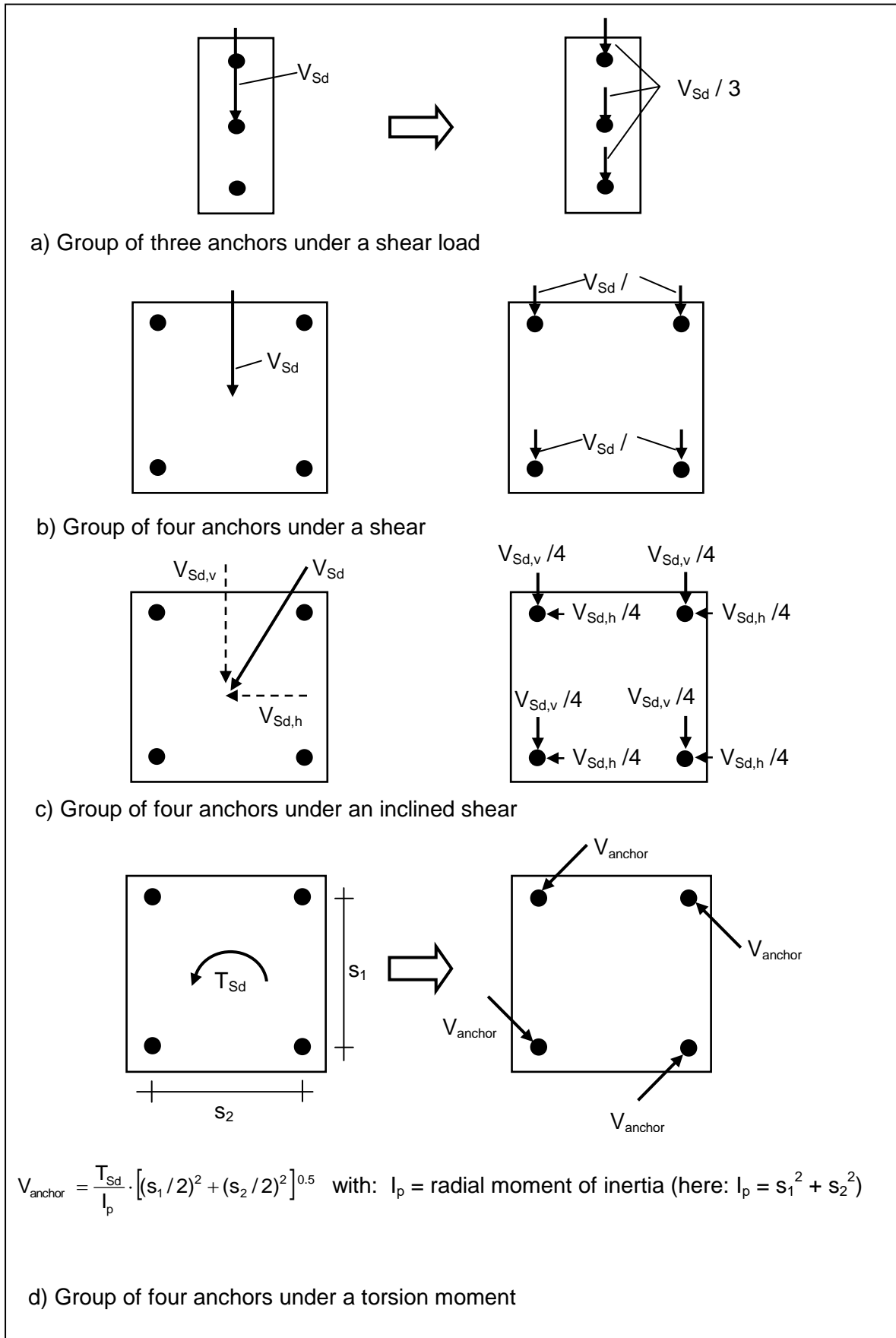
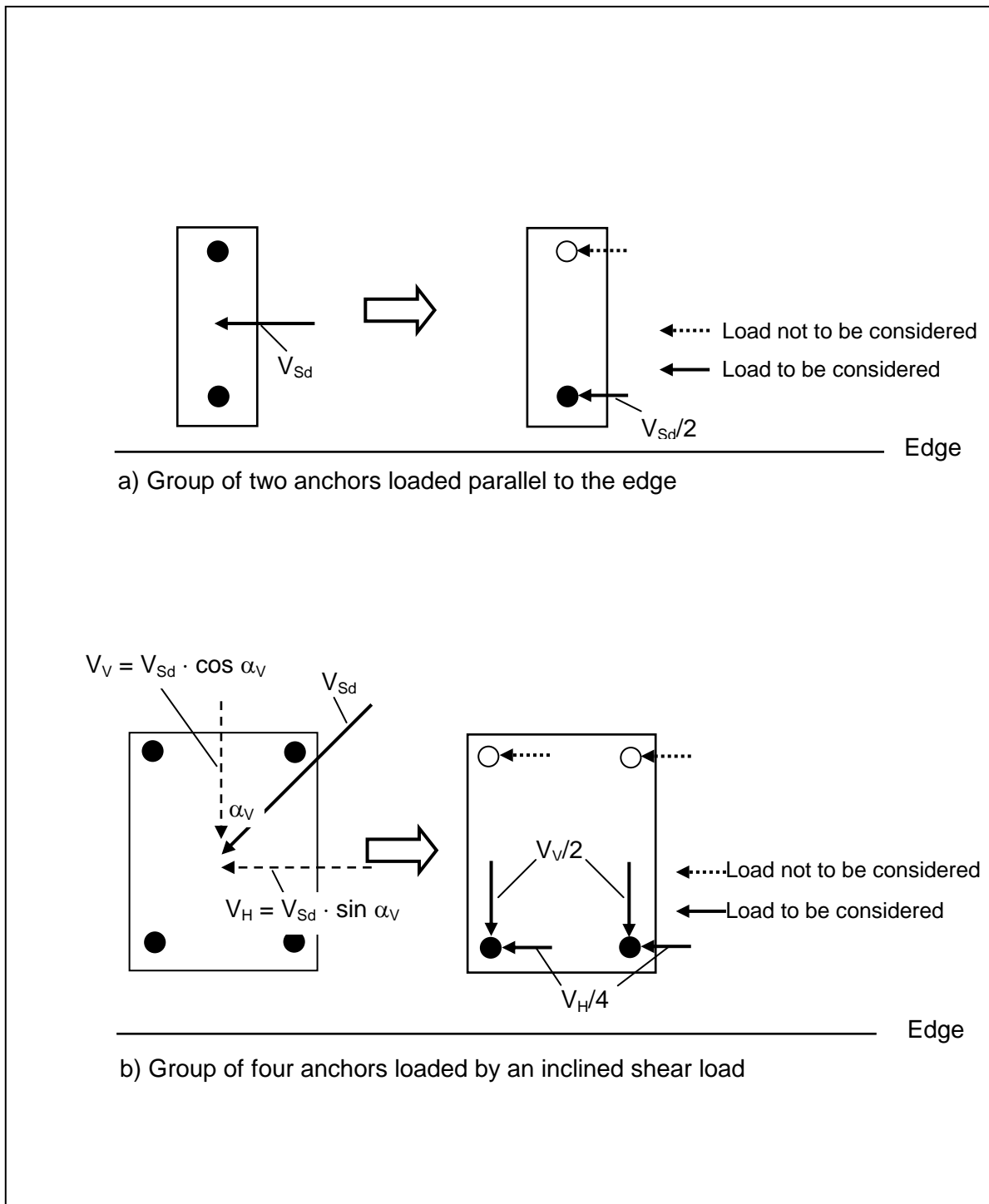

Figure 4.6 Determination of shear loads when all anchors take up loads (steel and pry-out failure)



**Figure 4.7** Determination of shear loads when only the most unfavourable anchors take up loads (concrete edge failure)

In case of concrete edge failure where only the most unfavourable anchors take up load the components of the load acting perpendicular to the edge are taken up by the most unfavourable anchors (anchors close to the edge), while the components of the load acting parallel to the edge are – due to reasons of equilibrium – equally distributed to all anchors of the group.

#### 4.2.2.3 Shear loads without lever arm

Shear loads acting on anchors may be assumed to act without lever arm if both of the following conditions are fulfilled:

- a) The fixture shall be made of metal and in the area of the anchorage be fixed directly to the concrete either without an intermediate layer or with a levelling layer of mortar (compression strength  $\geq 30 \text{ N/mm}^2$ ) with a thickness  $\leq d/2$ .
- b) The fixture shall be in contact with the anchor over its entire thickness.

#### 4.2.2.4 Shear loads with lever arm

If the conditions a) and b) of 4.2.2.3 are not fulfilled the lever arm is calculated according to Equation (4.2) (see Figure 4.8)

$$\ell = a_3 + e_1 \quad (4.2)$$

with

$e_1$  = distance between shear load and concrete surface

$a_3 = 0.5 d$

$a_3 = 0$  if a washer and a nut are directly clamped to the concrete surface (see Figure 4.8b)

$d$  = nominal diameter of the anchor bolt or thread diameter (see Figure 4.8a)

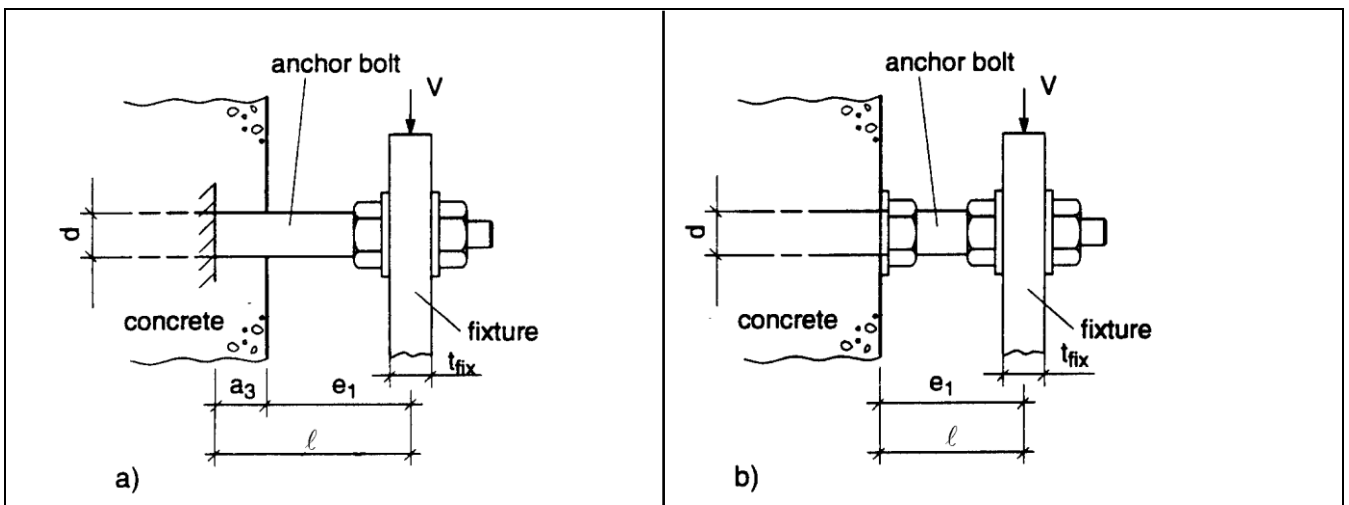

**Figure 4.8** Definition of lever arm

The design moment acting on the anchor is calculated according to Equation (4.3)

$$M_{Sd} = V_{Sd} \cdot \frac{\ell}{\alpha_M} \quad (4.3)$$

The value  $\alpha_M$  depends on the degree of restraint of the anchor at the side of the fixture of the application in question and shall be judged according to good engineering practice.

No restraint ( $\alpha_M = 1.0$ ) shall be assumed if the fixture can rotate freely (see Figure 4.9a). This assumption is always conservative.

Full restraint ( $\alpha_M = 2.0$ ) may be assumed only if the fixture cannot rotate (see Figure 4.9b) and the hole clearance in the fixture is smaller than the values given in Table 4.1 or the anchor is clamped to the fixture by nut and washer (see Figure 4.8). If restraint of the anchor is assumed the fixture shall be able to take up the restraint moment.

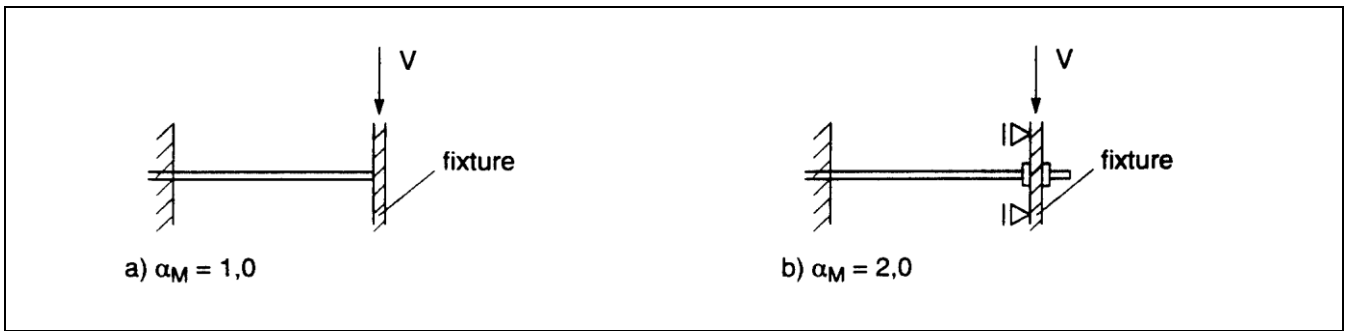

**Figure 4.9** Fixture without (a) and with (b) restraint

## 5 Ultimate limit state

### 5.1 General

For the design of anchorages in the ultimate limit state, there are three different design methods available. The linkage of the design methods and the required tests for admissible service conditions is given in Table 5.1. In 5.2 the general design method A is described; in 5.3 and 5.4 the simplified methods B and C are treated. The design method to be applied is given in the relevant ETA.

According to Equation (3.1) it shall be shown that the design value of the action is equal to or smaller than the design value of the resistance. The characteristic values of the anchor to be used for the calculation of the resistance in the ultimate limit state are given in the relevant ETA.

Spacing, edge distance as well as thickness of concrete member shall not remain under the given minimum values.

The spacing between the outer anchor of adjoining groups or the distance to single anchors shall be  $a > s_{cr,N}$  (design method A) or  $s_{cr}$  respectively (design method B and C).

**Table 5.1** Linkage of the design methods and the required tests for admissible service conditions

Design method	cracked and non-cracked concrete	non-cracked concrete only	characteristic resistance for		tests according Annex B Option
			C20/25 only	C20/25 to C50/60	
<b>A</b>	x			x	1
	x		x		2
		x		x	7
		x	x		8
<b>B</b>	x			x	3
	x		x		4
		x		x	9
		x	x		10
<b>C</b>	x			x	5
	x		x		6
		x		x	11
		x	x		12



## 5.2 Design method A

### 5.2.1 General

In design method A it shall be shown that Equation (3.1) is observed for all loading directions (tension, shear) as well as all failure modes (steel failure, pull-out failure, concrete cone failure, splitting failure, concrete edge failure and concrete pry-out failure).

In case of a combined tension and shear loading (oblique loading) the condition of interaction according to 5.2.4 shall be observed.

For Options 2 and 8 (see Part 1, Table 5.3),  $f_{ck,cube} = 25 \text{ N/mm}^2$  shall be inserted in Equations (5.2a) and (5.7a).

### 5.2.2 Resistance to tension loads

#### 5.2.2.1 Required proofs

	single anchor	anchor group	
steel failure	$N_{Sd} \leq N_{Rk,s} / \gamma_{Ms}$	$N_{Sd}^h \leq N_{Rk,s} / \gamma_{Ms}$	
pull-out failure	$N_{Sd} \leq N_{Rk,p} / \gamma_{Mp}$	$N_{Sd}^h \leq N_{Rk,p} / \gamma_{Mp}$	
concrete cone failure	$N_{Sd} \leq N_{Rk,c} / \gamma_{Mc}$		$N_{Sd}^g \leq N_{Rk,c} / \gamma_{Mc}$
splitting failure	$N_{Sd} \leq N_{Rk,sp} / \gamma_{Msp}$		$N_{Sd}^g \leq N_{Rk,sp} / \gamma_{Msp}$

#### 5.2.2.2 Steel failure

The characteristic resistance of an anchor in case of steel failure,  $N_{Rk,s}$ , is given in the relevant ETA.

*The value of  $N_{Rk,s}$  is obtained from Equation (5.1)*

$$N_{Rk,s} = A_s \cdot f_{uk} \quad [N] \quad (5.1)$$

#### 5.2.2.3 Pull-out failure

The characteristic resistance in case of failure by pull-out,  $N_{Rk,p}$ , is given in the relevant ETA.

#### 5.2.2.4 Concrete cone failure

The characteristic resistance of an anchor or a group of anchors, in case of concrete cone failure is:

$$N_{Rk,c} = N_{Rk,c}^0 \cdot \frac{A_{c,N}}{A_{c,N}^0} \cdot \psi_{s,N} \cdot \psi_{re,N} \cdot \psi_{ec,N} \quad [N] \quad (5.2)$$

The different factors of Equation (5.2) for anchors according to current experience are given below:

- a) The initial value of the characteristic resistance of an anchor placed in cracked or non-cracked concrete is obtained by:

$$N_{Rk,c}^0 = k_1 \cdot \sqrt{f_{ck,cube}} \cdot h_{ef}^{1.5} \quad [N] \quad (5.2a)$$

$f_{ck,cube}$  [N/mm<sup>2</sup>];  $h_{ef}$  [mm]

$k_1 = 7.2$  for applications in cracked concrete

$k_1 = 10.1$  for applications in non-cracked concrete

- b) The geometric effect of spacing and edge distance on the characteristic resistance is taken into account by the value  $A_{c,N}/A_{c,N}^0$ , where

$A_{c,N}^0$  = area of concrete of an individual anchor with large spacing and edge distance at the concrete surface, idealizing the concrete cone as a pyramid with a height equal to  $h_{ef}$  and a base length equal to  $s_{cr,N}$  (see Figure 5.1).

$$= s_{cr,N} \cdot s_{cr,N} \quad (5.2b)$$

$A_{c,N}$  = actual area of concrete cone of the anchorage at the concrete surface. It is limited by overlapping concrete cones of adjoining anchors ( $s \leq s_{cr,N}$ ) as well as by edges of the concrete member ( $c \leq c_{cr,N}$ ). Examples for the calculation of  $A_{c,N}$  are given in Figure 5.2.

The values  $s_{cr,N}$  and  $c_{cr,N}$  are given in the relevant ETA.

*For an anchor according to current experience  $s_{cr,N} = 2 c_{cr,N} = 3 h_{ef}$  is taken.*

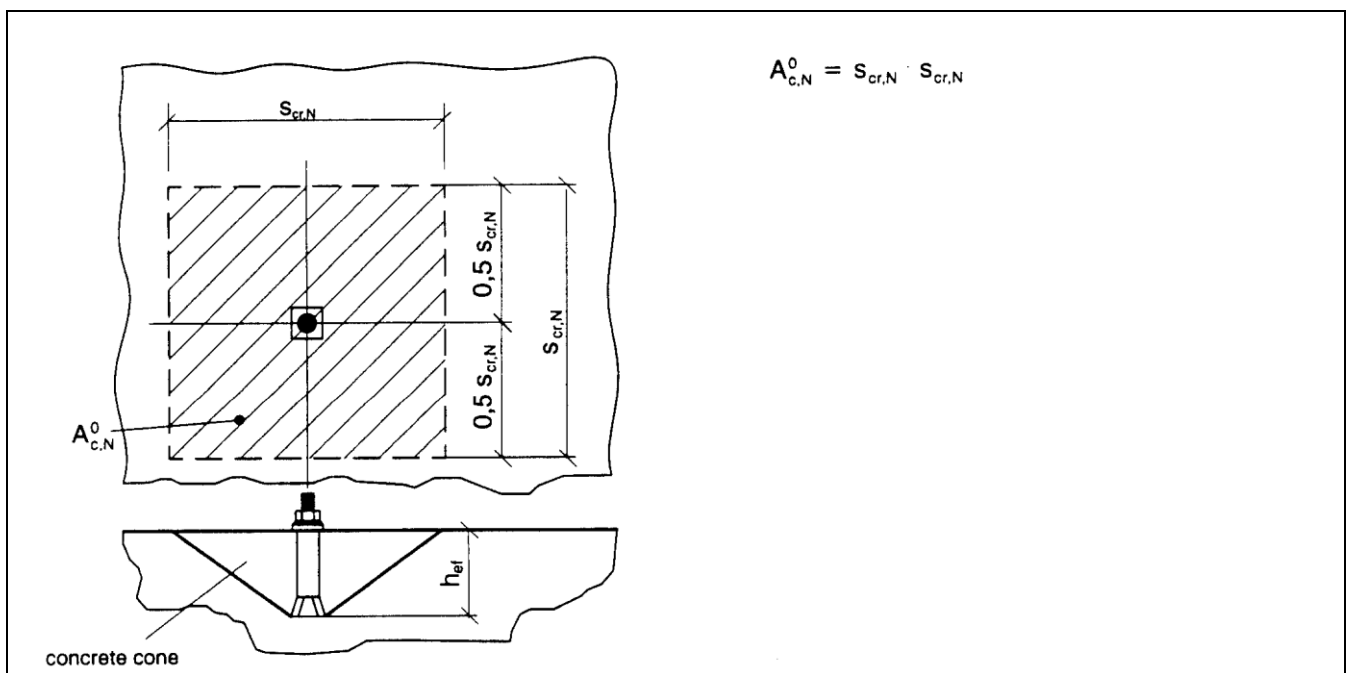

**Figure 5.1** Idealized concrete cone and area  $A_{c,N}^0$  of concrete cone of an individual anchor

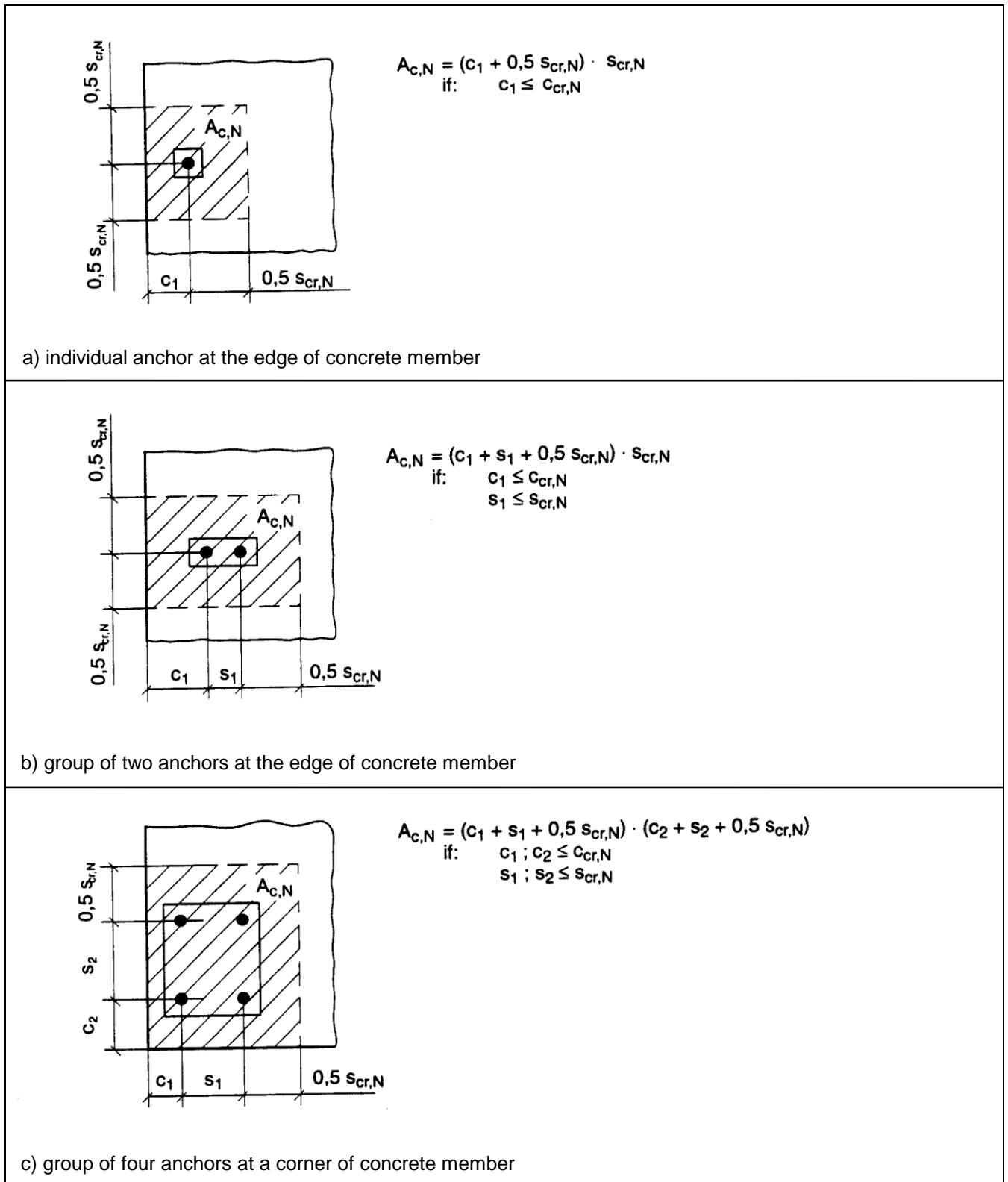

**Figure 5.2** Examples of actual areas  $A_{c,N}$  of the idealized concrete cones for different arrangements of anchors in the case of axial tension load

- c) The factor  $\psi_{s,N}$  takes account of the disturbance of the distribution of stresses in the concrete due to edges of the concrete member. For anchorages with several edge distances (e.g. anchorage in a corner of the concrete member or in a narrow member), the smallest edge distance,  $c$ , shall be inserted in Equation (5.2c).

$$\psi_{s,N} = 0,7 + 0,3 \cdot \frac{c}{c_{cr,N}} \leq 1 \quad (5.2c)$$

- d) The shell spalling factor,  $\psi_{re,N}$ , takes account of the effect of a reinforcement

$$\psi_{re,N} = 0.5 + \frac{h_{ef}}{200} \leq 1 \quad (5.2d)$$

with  $h_{ef}$  in [mm]

If in the area of the anchorage there is a reinforcement with a spacing  $\geq 150$  mm (any diameter) or with a diameter  $\leq 10$  mm and a spacing  $\geq 100$  mm then a shell spalling factor of  $\psi_{re,N} = 1.0$  may be applied independently of the anchorage depth.

- e) The factor of  $\psi_{ec,N}$  takes account of a group effect when different tension loads are acting on the individual anchors of a group.

$$\psi_{ec,N} = \frac{1}{1 + 2e_N/s_{cr,N}} \leq 1 \quad (5.2e)$$

$e_N$  = eccentricity of the resulting tensile load acting on the tensioned anchors (see 4.2.1). Where there is an eccentricity in two directions,  $\psi_{ec,N}$  shall be determined separately for each direction and the product of both factors shall be inserted in Equation (5.2).

As a simplification factor  $\psi_{ec,N} = 1.0$  may be assumed, if the most stressed anchor is checked according to Equation (3.1) ( $N_{Sd}^h \leq N_{Rk,c}^h / \gamma_{Mc}$ ) and the resistance of this anchor is taken as

$$N_{Rk,c}^h = N_{Rk,c} / n \quad (5.2f)$$

with  $n$  = number of tensioned anchors

- f) Special cases

For anchorages with three or more edges with an edge distance  $c_{max} \leq c_{cr,N}$  ( $c_{max}$  = largest edge distance) (see Figure 5.3) the calculation according to Equation 5.2 leads to results which are conservative.

More precise results are obtained if for  $h_{ef}$  the larger value

$$h'_{ef} = \frac{c_{max}}{c_{cr,N}} \cdot h_{ef} \quad \text{or} \quad h'_{ef} = \frac{s_{max}}{s_{cr,N}} h_{ef}$$

is inserted in Equation (5.2a) and for the determination of  $A_{c,N}^0$  and  $A_{c,N}$  according to Figures 5.1 and 5.2 as well as in Equations (5.2b), (5.2c) and (5.2e) the values

$$s'_{cr,N} = \frac{h'_{ef}}{h_{ef}} \cdot s_{cr,N}$$

$$c'_{cr,N} = 0.5 s'_{cr,N}$$

are inserted for  $s_{cr,N}$  or  $c_{cr,N}$ , respectively.

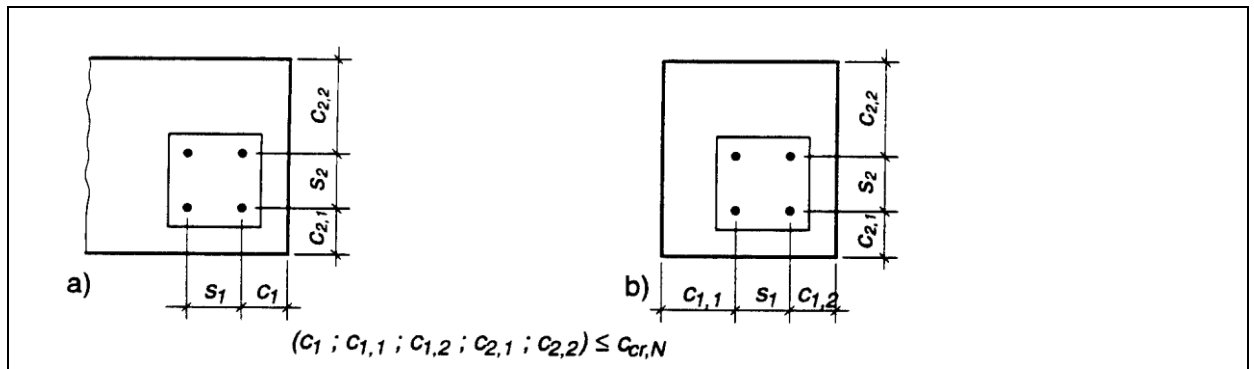

**Figure 5.3** Examples of anchorages in concrete members where  $h_{ef}$ ,  $s_{cr,N}$  and  $c_{cr,N}$  may be used

### 5.2.2.5 Splitting failure due to anchor installation

Splitting failure is avoided during anchor installation by complying with minimum values for edge distance  $c_{min}$ , spacing  $s_{min}$ , member thickness  $h_{min}$  and reinforcement as given in the relevant ETA.

### 5.2.2.6 Splitting failure due to loading

For splitting failure due to loading the values  $s_{cr,sp}$  and  $c_{cr,sp}$  are given in the ETA.

- It may be assumed that splitting failure will not occur, if the edge distance in all directions is  $c \geq 1.2 c_{cr,sp}$  and the member depth is  $h \geq 2 h_{ef}$ .
- With anchors suitable for use in cracked concrete, the calculation of the characteristic splitting resistance may be omitted if the following two conditions are fulfilled:
  - a reinforcement is present which limits the crack width to  $w_k \sim 0.3$  mm, taking into account the splitting forces according to 7.3
  - The characteristic resistance for concrete cone failure and pull-out failure is calculated for cracked concrete.

If the conditions a) and b) are not fulfilled, then the characteristic resistance of a single anchor or an anchor group in case of splitting failure shall be calculated according to Equation (5.3).

$$N_{Rk,sp} = N_{Rk,c}^0 \cdot \frac{A_{c,N}}{A_{c,N}^0} \cdot \psi_{s,N} \cdot \psi_{re,N} \cdot \psi_{ec,N} \cdot \psi_{h,sp} \quad [N] \quad (5.3)$$

with  $N_{Rk,c}^0$ ,  $\psi_{s,N}$ ,  $\psi_{re,N}$ ,  $\psi_{ec,N}$  according to Equations (5.2a) to (5.2e) and  $A_{c,N}$ ,  $A_{c,N}^0$  as defined in 5.2.2.4 b), however the values  $c_{cr,N}$  and  $s_{cr,N}$  shall be replaced by  $c_{cr,sp}$  and  $s_{cr,sp}$ .

$\psi_{h,sp}$  = factor to account for the influence of the actual member depth,  $h$ , on the splitting resistance for anchors according to current experience

$$= \left( \frac{h}{h_{min}} \right)^{2/3} \leq 1.5 \quad (5.3a)$$

where

$h$  = actual thickness of the member

$h_{min}$  = member thickness, for which  $c_{cr,sp}$  has been evaluated

### 5.2.3 Resistance to shear loads

#### 5.2.3.1 Required proofs

	single anchor	anchor group	
steel failure, shear load without lever arm	$V_{Sd} \leq V_{Rk,s} / \gamma_{Ms}$	$V_{Sd}^h \leq V_{Rk,s} / \gamma_{Ms}$	
steel failure, shear load with lever arm	$V_{Sd} \leq V_{Rk,s} / \gamma_{Ms}$	$V_{Sd}^h \leq V_{Rk,s} / \gamma_{Ms}$	
concrete pry-out failure	$V_{Sd} \leq V_{Rk,cp} / \gamma_{Mc}$		$V_{Sd}^g \leq V_{Rk,cp} / \gamma_{Mc}$
concrete edge failure	$V_{Sd} \leq V_{Rk,c} / \gamma_{Mc}$		$V_{Sd}^g \leq V_{Rk,c} / \gamma_{Mc}$

#### 5.2.3.2 Steel failure

##### a) Shear load without lever arm

The characteristic resistance of an anchor in case of steel failure,  $V_{Rk,s}$  is given in the relevant ETA.

*The value  $V_{Rk,s}$  for anchors according to current experience is obtained from Equation (5.4)*

$$V_{Rk,s} = 0.5 \cdot A_s \cdot f_{uk} \quad [N] \quad (5.4)$$

*Equation (5.4) is not valid for anchors with a significantly reduced section along the length of the bolt (e.g. in case of bolt type expansion anchors).*

In case of anchor groups, the characteristic shear resistance given in the relevant ETA shall be multiplied by a factor 0.8, if the anchor is made of steel with a rather low ductility (rupture elongation  $A_5 \leq 8\%$ )

##### b) Shear load with lever arm

The characteristic resistance of an anchor,  $V_{Rk,s}$ , is given by Equation (5.5).

$$V_{Rk,s} = \frac{\alpha_M \cdot M_{Rk,s}}{\ell} \quad [N] \quad (5.5)$$

where  $\alpha_M$  = see 4.2.2.4

$\ell$  = lever arm according to Equation (4.2)

$$M_{Rk,s} = M_{Rk,s}^0 (1 - N_{Sd}/N_{Rd,s}) \quad [Nm] \quad (5.5a)$$

$N_{Rd,s}$  =  $N_{Rk,s} / \gamma_{Ms}$

$N_{Rk,s}, \gamma_{Ms}$  to be taken from the relevant ETA

$M_{Rk,s}^0$  = characteristic bending resistance of an individual anchor

The characteristic bending resistance  $M_{Rk,s}^0$  is given in the relevant ETA.

*The value of  $M_{Rk,s}^0$  for anchors according to current experience is obtained from Equation (5.5b).*

$$M_{Rk,s}^0 = 1.2 \cdot W_{el} \cdot f_{uk} \quad [Nm] \quad (5.5b)$$

*Equation (5.5b) may be used only if the anchor has not a significantly reduced section along the length of the bolt.*

**5.2.3.3 Concrete pry-out failure**

Anchorage can fail by a concrete pry-out failure at the side opposite to the load direction (see Figure 5.4). The corresponding characteristic resistance  $V_{Rk,cp}$  may be calculated from Equation (5.6).

$$V_{Rk,cp} = k \cdot N_{Rk,c} \tag{5.6}$$

where  $k$  = factor to be taken from the relevant ETA  
 $N_{Rk,c}$  according to 5.2.2.4 determined for single anchors or all anchors of a group loaded in shear.

*For anchors according to current experience failing under tension load by concrete cone failure the following values are conservative*

$$k = 1 \quad h_{ef} < 60mm \tag{5.6c}$$

$$k = 2 \quad h_{ef} \geq 60mm \tag{5.6d}$$

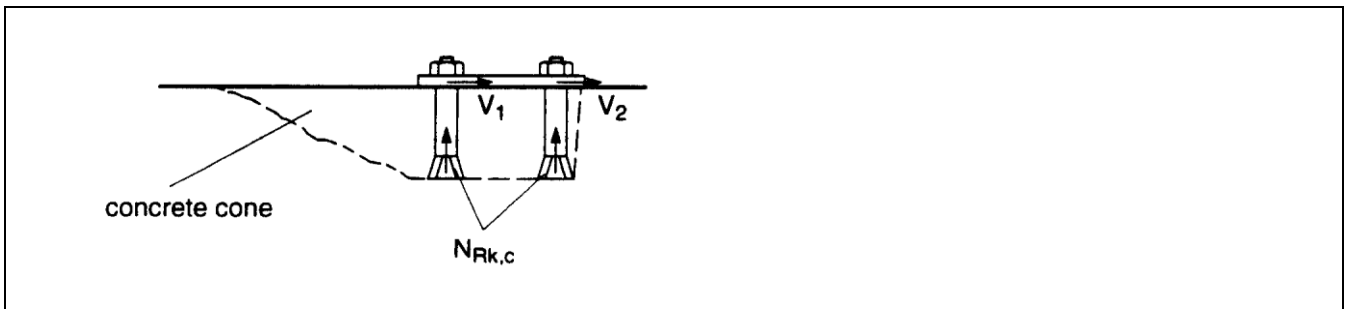

**Figure 5.4** Concrete pry-out failure on the side opposite to load direction

In cases where the group is loaded by shear loads and/or external torsion moments, the direction of the individual shear loads may alter. Fig. 5.5 demonstrates this for a group of two anchors loaded by a torsion moment.

It is self-explanatory that Equation (5.6) is not suitable for this application. The shear loads acting on the individual anchors neutralise each other and the shear load acting on the entire group is  $V_{Sd} = 0$ .

In cases where the horizontal or vertical components of the shear loads on the anchors alter their direction within a group the verification of pry-out failure for the entire group is substituted by the verification of pry-out failure for the most unfavourable anchor of the group.

When calculating the resistance of the most unfavourable anchor, the influences of both edge distances as well as anchor spacing shall be considered. Examples for the calculation of  $A_{c,N}$  are given in Fig. 5.6.

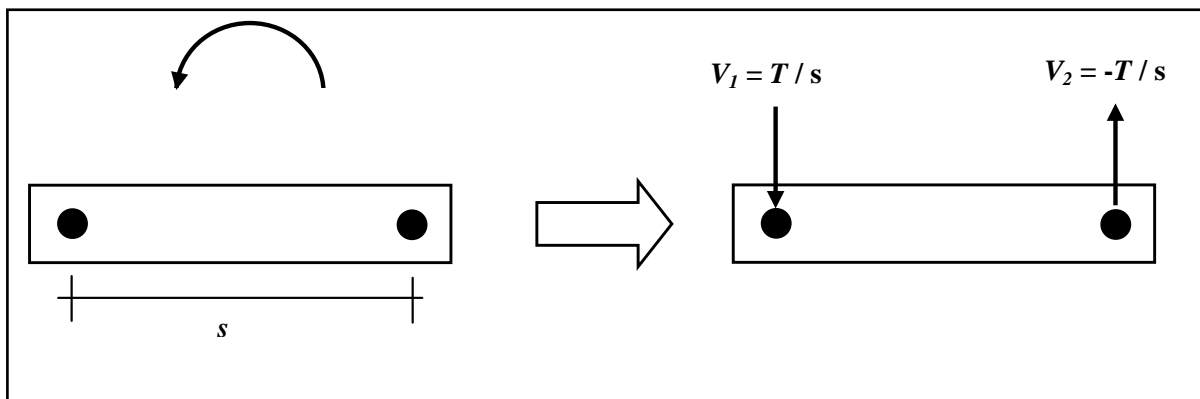

**Figure 5.5** Group of anchors loaded by a torsion moment; Shear loads acting on the individual anchors of the group alter their directions

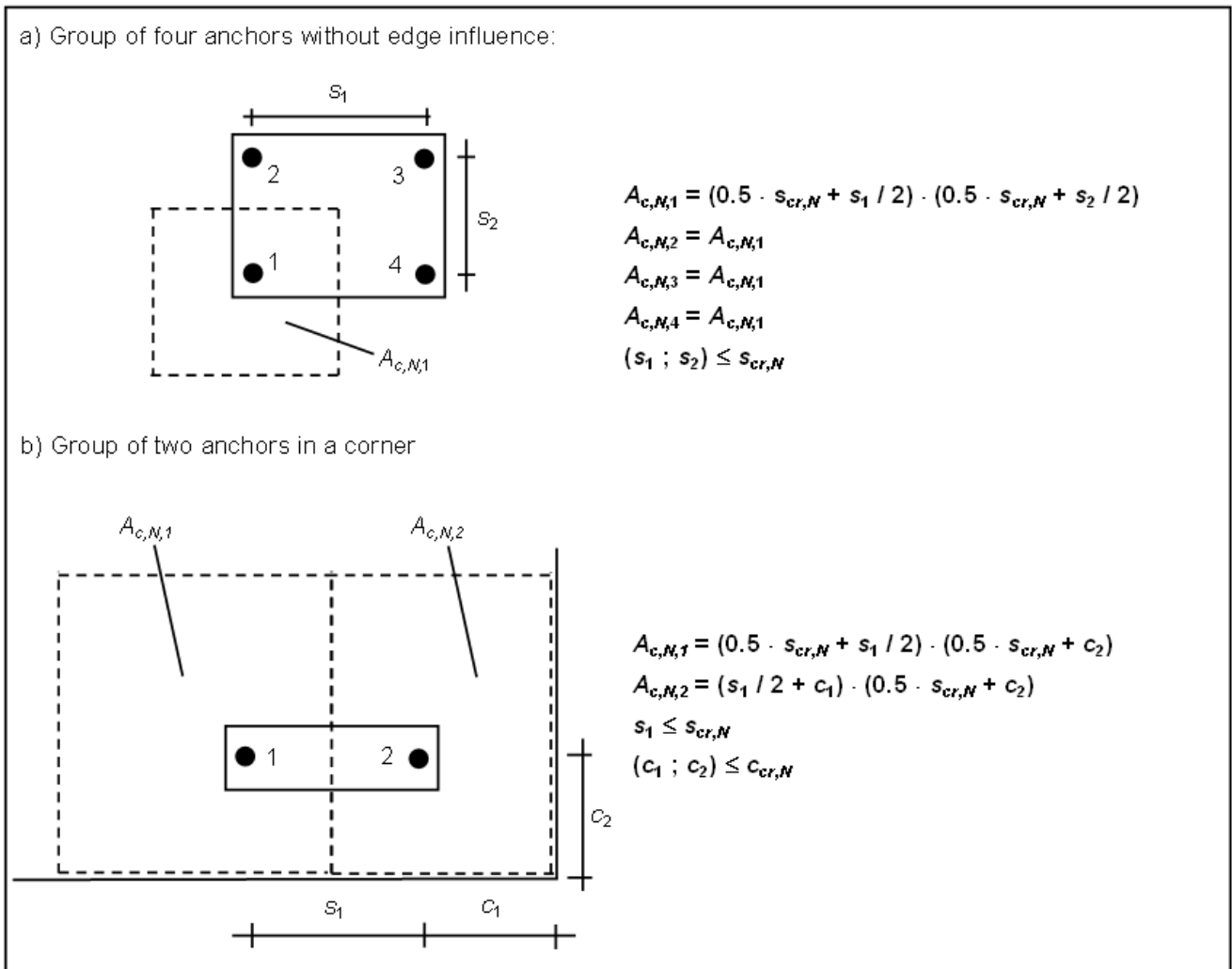

**Figure 5.6** Examples for the calculation of the area  $A_{c,N}$  of the idealised concrete cones

#### 5.2.3.4 Concrete edge failure

Concrete edge failure need not be verified for groups with not more than 4 anchors when the edge distance in all directions is  $c > 10 h_{ef}$  and  $c > 60 d$ .

The characteristic resistance for an anchor or an anchor group in the case of concrete edge failure corresponds to:

$$V_{Rk,c} = V_{Rk,c}^0 \cdot \frac{A_{c,V}}{A_{c,V}^0} \cdot \psi_{s,V} \cdot \psi_{h,V} \cdot \psi_{\alpha,V} \cdot \psi_{ec,V} \cdot \psi_{re,V} \quad [\text{N}] \quad (5.7)$$

The different factors of Equation (5.7) for anchors according to current experience are given below:



- a) The initial value of the characteristic resistance of an anchor placed in cracked or non-cracked concrete and loaded perpendicular to the edge corresponds to:

$$V_{Rk,c}^0 = k_1 \cdot d_{nom}^\alpha \cdot h_{ef}^\beta \cdot \sqrt{f_{ck,cube}} \cdot c_1^{1.5} \quad (5.7a)$$

$d_{nom}$ ,  $l_f$ ,  $c_1$  [mm];  $f_{ck,cube}$  [N/mm<sup>2</sup>]

where

$k_1 = 1.7$  for applications in cracked concrete

$k_1 = 2.4$  for applications in non-cracked concrete

$$\alpha = 0.1 \cdot \left( \frac{l_f}{c_1} \right)^{0.5} \quad (5.7b)$$

$$\beta = 0.1 \cdot \left( \frac{d_{nom}}{c_1} \right)^{0.2} \quad (5.7c)$$

- b) The geometrical effect of spacing as well as of further edge distances and the effect of thickness of the concrete member on the characteristic load is taken into account by the ratio  $A_{c,v}/A_{c,v}^0$ .

where

$A_{c,v}^0$  = area of concrete cone of an individual anchor at the lateral concrete surface not affected by edges parallel to the assumed loading direction, member thickness or adjacent anchors, assuming the shape of the fracture area as a half pyramid with a height equal to  $c_1$  and a base-length of  $1.5 c_1$  and  $3 c_1$  (Figure 5.7).

$$= 4.5 c_1^2 \quad (5.7d)$$

$A_{c,v}$  = actual area of concrete cone of anchorage at the lateral concrete surface. It is limited by the overlapping concrete cones of adjoining anchors ( $s \leq 3 c_1$ ) as well as by edges parallel to the assumed loading direction ( $c_2 \leq 1.5 c_1$ ) and by member thickness ( $h \leq 1.5 c_1$ ). Examples for calculation of  $A_{c,v}$  are given in Figure 5.8.

For the calculation of  $A_{c,v}^0$  and  $A_{c,v}$  it is assumed that the shear loads are applied perpendicular to the edge of the concrete member.

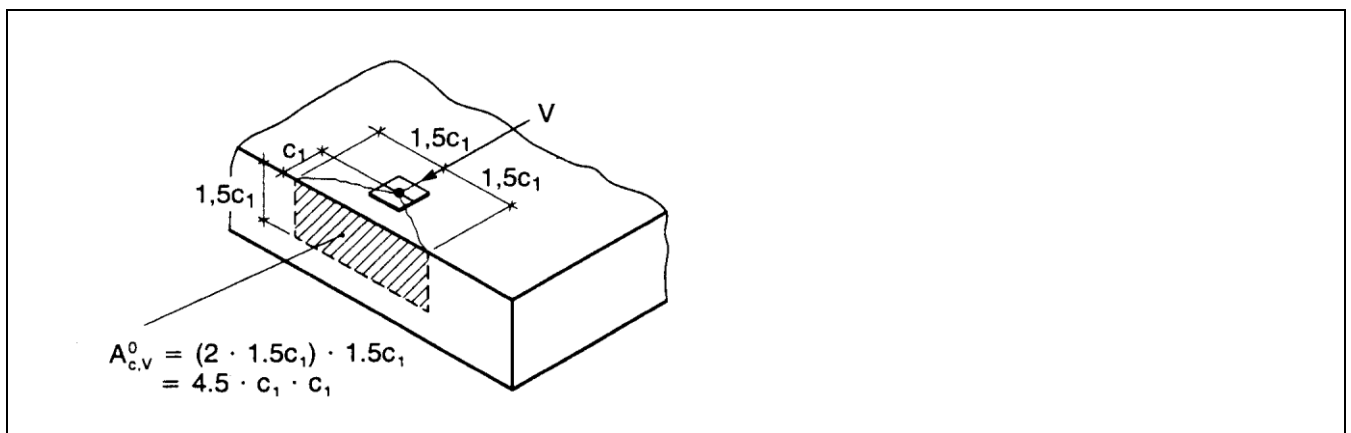

**Figure 5.7** Idealized concrete cone and area  $A_{c,v}^0$  of concrete cone for a single anchor

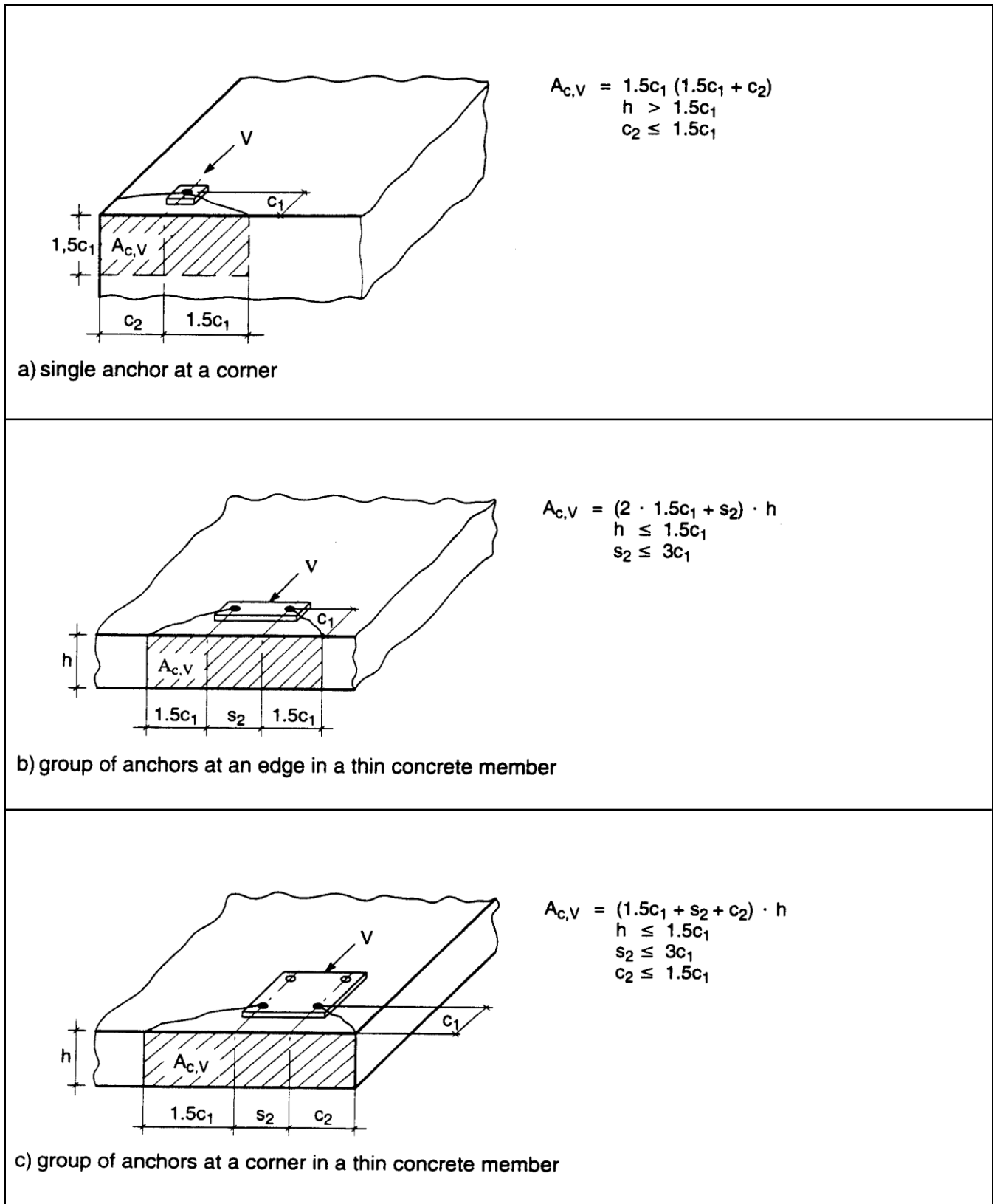

**Figure 5.8** Examples of actual areas of the idealized concrete cones for different anchor arrangements under shear loading

- c) The factor  $\psi_{s,V}$  takes account of the disturbance of the distribution of stresses in the concrete due to further edges of the concrete member on the shear resistance. For anchorages with two edges parallel to the assumed direction of loading (e.g. in a narrow concrete member) the smaller edge distance shall be inserted in Equation (5.7e).

$$\psi_{s,V} = 0.7 + 0.3 \cdot \frac{c_2}{1.5c_1} \leq 1 \quad (5.7e)$$

- d) The factor  $\psi_{h,V}$  takes account of the fact that the shear resistance does not decrease proportionally to the member thickness as assumed by the ratio  $A_{c,V}/A_{c,V}^0$ .

$$\psi_{h,V} = \left( \frac{1.5c_1}{h} \right)^{1/2} \geq 1 \quad (5.7f)$$

- e) The factor  $\psi_{\alpha,V}$  takes account of the angle  $\alpha_V$  between the load applied,  $V_{Sd}$ , and the direction perpendicular to the free edge of the concrete member (see Figure 4.7b).

$$\psi_{\alpha,V} = \sqrt{\frac{1}{(\cos \alpha_V)^2 + \left( \frac{\sin \alpha_V}{2.5} \right)^2}} \geq 1.0 \quad (5.7g)$$

The maximum value  $\alpha_V$  to be inserted in equation (5.7g) is limited to 90°.

In case of  $\alpha_V > 90^\circ$  it is assumed that only the component of the shear load parallel to the edge is acting on the anchor. The component acting away from the edge may be neglected for the proof of concrete edge failure. Examples of anchor groups loaded by  $M_{Td}$ ,  $V_{Sd}$  or both are given in Fig. 5.9 and Fig. 5.10.

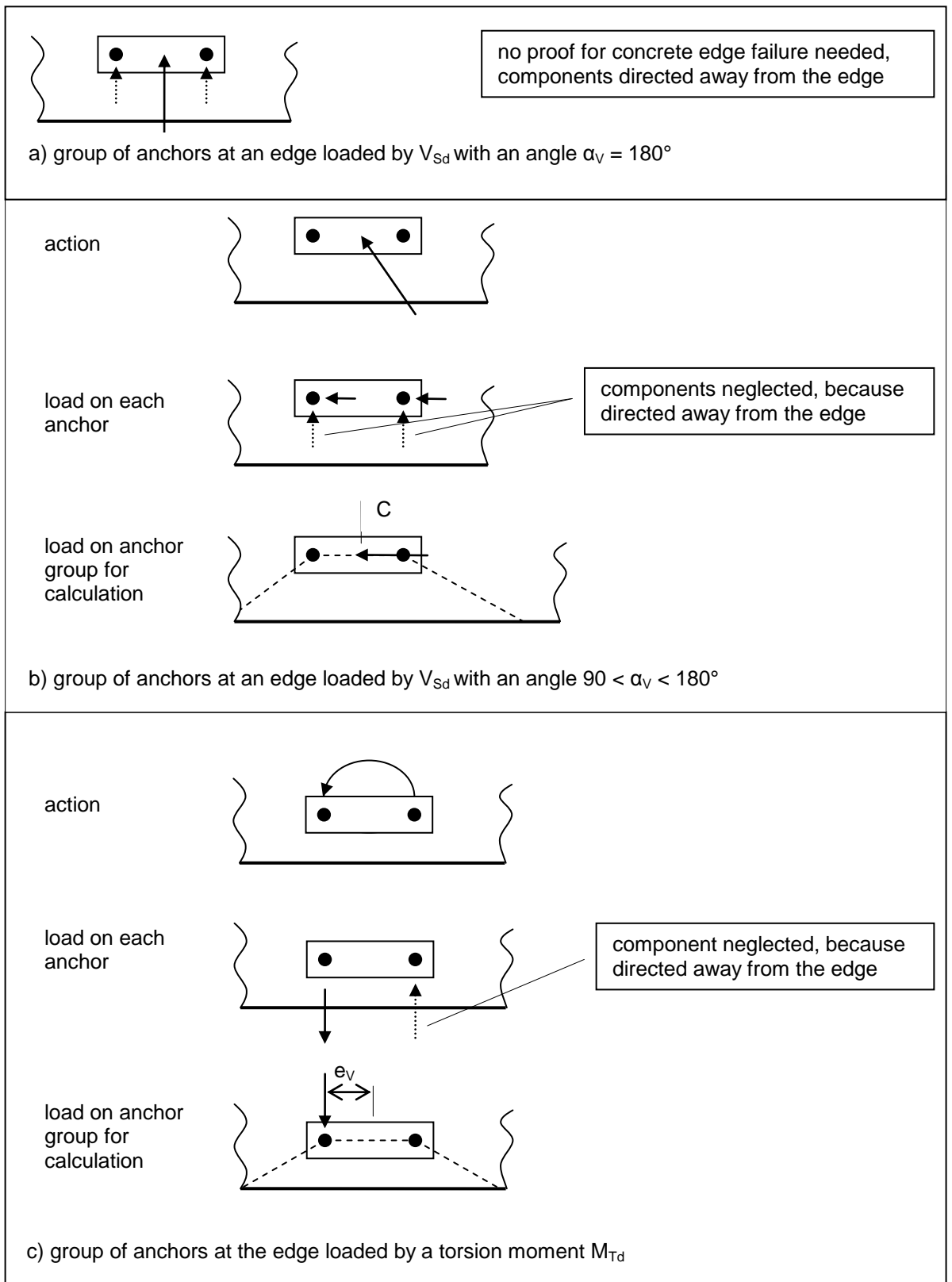

**Figure 5.9** Examples of anchor groups at the edge loaded by a shear force or a torsion moment

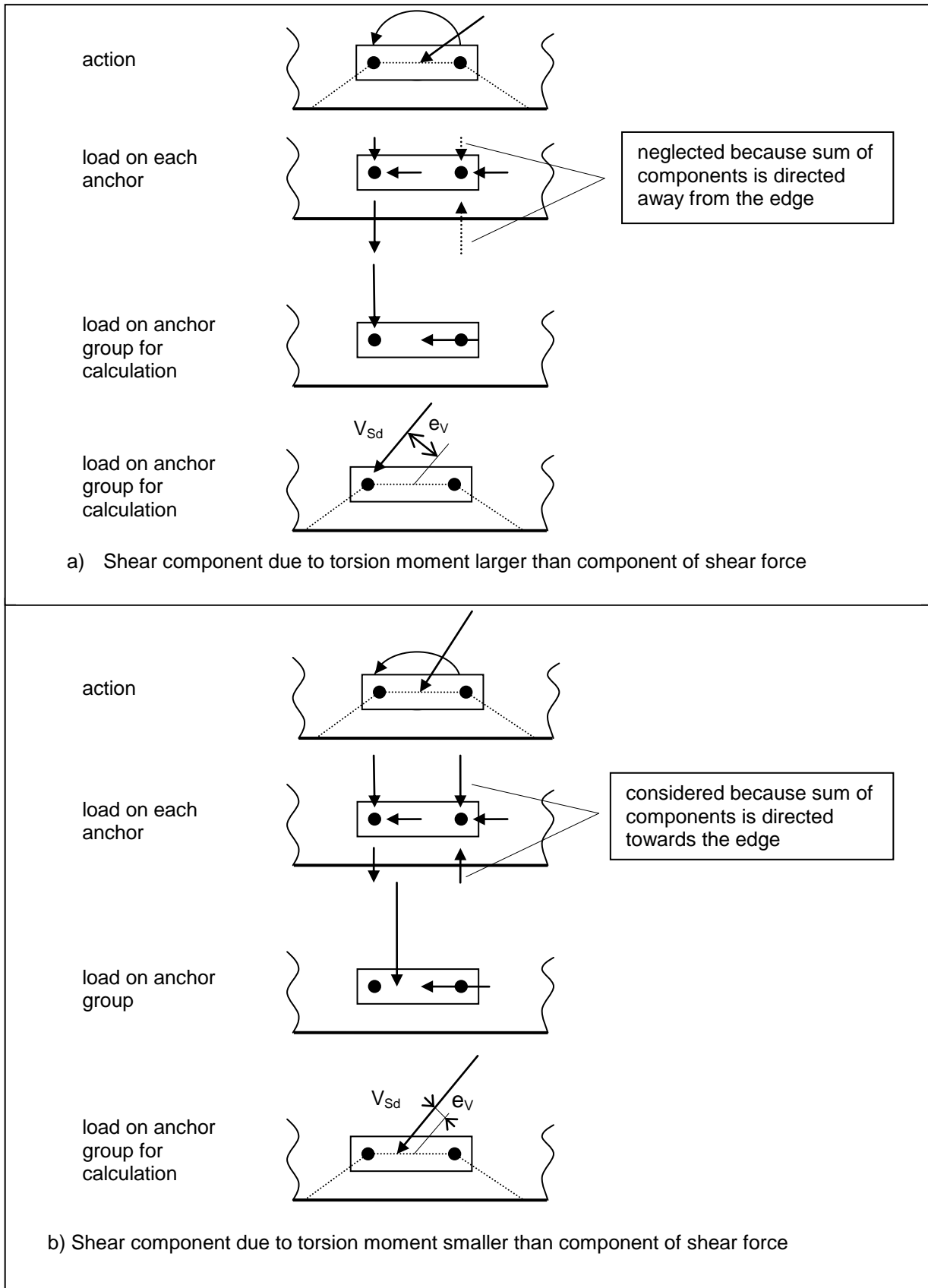

**Figure 5.10** Examples of anchors groups at the edge loaded by a shear force and a torsion moment

- f) The factor  $\psi_{ec,V}$  takes account of a group effect when different shear loads are acting on the individual anchors of a group.

$$\psi_{ec,V} = \frac{1}{1 + 2e_V / (3c_1)} \leq 1 \quad (5.7h)$$

$e_V$  = eccentricity of the resulting shear load acting on the anchors (see 4.2.2).

- g) The factor  $\psi_{re,V}$  takes account of the effect of the type of reinforcement used in cracked concrete.

$\psi_{re,V} = 1.0$  anchorage in non-cracked concrete and anchorage in cracked concrete without edge reinforcement or stirrups

$\psi_{re,V} = 1.2$  anchorage in cracked concrete with straight edge reinforcement ( $\geq \text{Ø}12$  mm)

$\psi_{re,V} = 1.4$  anchorage in cracked concrete with edge reinforcement and closely spaced stirrups ( $a \leq 100$  mm)

- h) For anchorages placed in a corner, the resistances for both edges shall be calculated and the smallest value is decisive.

- i) Special cases

For anchorages in a narrow, thin member with  $c_{2,max} \leq 1.5 c_1$  ( $c_{2,max}$  = greatest of the two edge distances parallel to the direction of loading) and  $h \leq 1.5 c_1$  see Figure 5.11 the calculation according to Equation (5.7) leads to results which are conservative.

More precise results are achieved if in Equations (5.7a) to (5.7f) as well as in the determination of the areas  $A_{c,V}^0$  and  $A_{c,V}$  according to Figures 5.7 and 5.8 the edge distance  $c_1$  is replaced by the value of  $c'_1$ .  $c'_1$  being the greatest of the two values  $c_{2,max}/1.5$  and  $h/1.5$  or  $s_{2,max}/3$  in case of anchor groups.

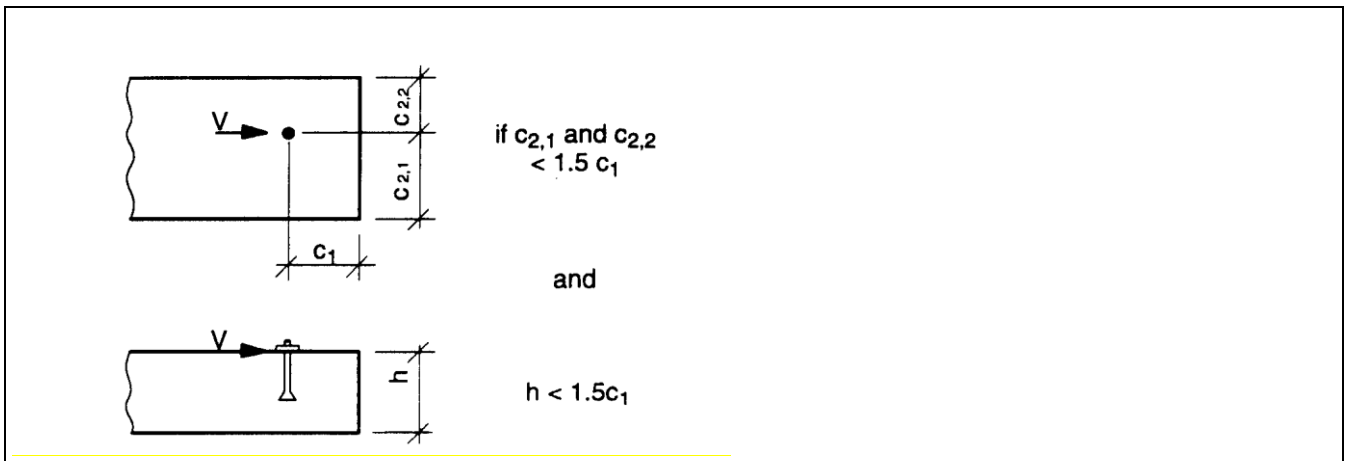

**Figure 5.11** Example of an anchorage in a thin, narrow member where the value  $c'_1$  may be used

#### 5.2.4 Resistance to combined tension and shear loads

For combined tension and shear loads the following Equations (see Figure 5.12) shall be satisfied:

$$\beta_N \leq 1 \quad (5.8a)$$

$$\beta_V \leq 1 \quad (5.8b)$$

$$\beta_N + \beta_V \leq 1.2 \quad (5.8c)$$

where

$\beta_N$  ( $\beta_V$ ): ratio between design action and design resistance for tension (shear) loading.

In Equation (5.8) the largest value of  $\beta_N$  and  $\beta_V$  for the different failure modes shall be taken (see 5.2.2.1 and 5.2.3.1).

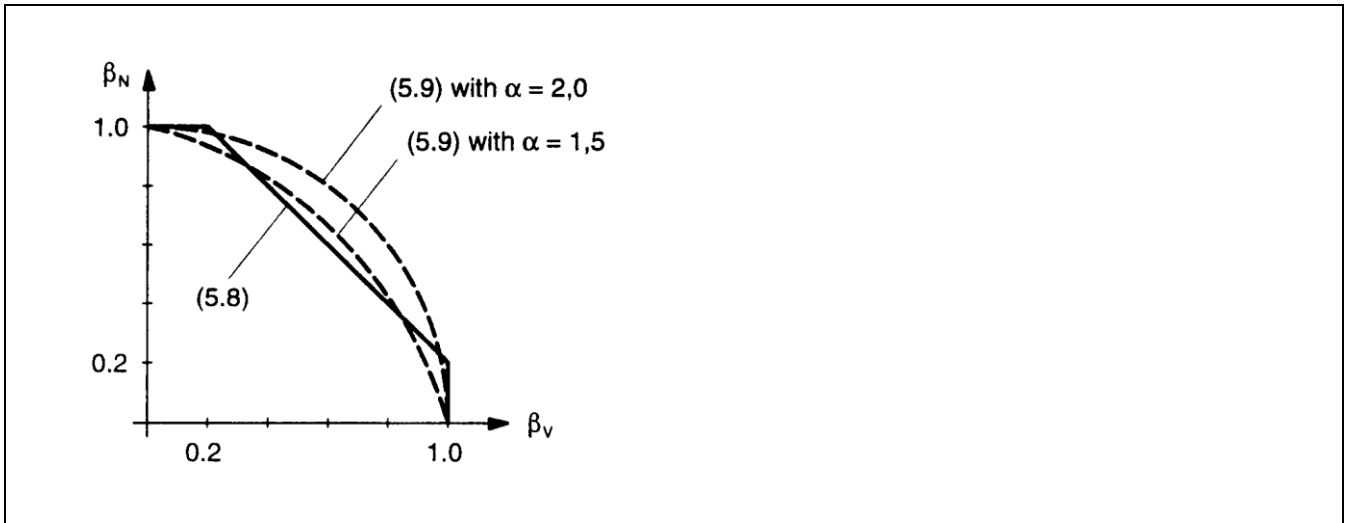

**Figure 5.12** Interaction diagram for combined tension and shear loads

In general, Equations (5.8a) to (5.8c) yield conservative results. More accurate results are obtained by Equation (5.9)

$$(\beta_N)^\alpha + (\beta_V)^\alpha \leq 1 \quad (5.9)$$

with:

$\beta_N, \beta_V$  see Equations (5.8)  
 $\alpha = 2.0$  if  $N_{Rd}$  and  $V_{Rd}$  are governed by steel failure  
 $\alpha = 1.5$  for all other failure modes

### 5.3 Design method B

Design method B<sub>7</sub> is based on a simplified approach in which the design value of the characteristic resistance is considered to be independent of the loading direction and the mode of failure.

In case of anchor groups it shall be shown that Equation (3.1) is observed for the most stressed anchor.

The design resistance  $F_{Rd}^0$  may be used without modification if the spacing  $s_{cr}$  and the edge distance  $c_{cr}$  are observed.  $F_{Rd}^0$ ,  $s_{cr}$  and  $c_{cr}$  are given in the ETA.

The design resistance shall be calculated according to Equation (5.10) if the actual values for spacing and edge distance are smaller than the values  $s_{cr}$  and  $c_{cr}$  and larger than or equal to  $s_{min}$  and  $c_{min}$  given in the ETA.

$$F_{Rd} = \frac{1}{n} \cdot \frac{A_c}{A_c^0} \cdot \psi_s \cdot \psi_{re} \cdot F_{Rd}^0 \quad [N] \quad (5.10)$$

where

$n$  = number of loaded anchors

$F_{Rd}^0$  = design resistance given in the relevant ETA for cracked or non-cracked concrete

The effect of spacing and edge distance is taken into account by the factor  $A_c/A_c^0$  and  $\psi_s$ . The factor  $A_c/A_c^0$  shall be calculated according to 5.2.2.4b and the factor  $\psi_s$  shall be calculated according to 5.2.2.4c replacing  $s_{cr,N}$  and  $c_{cr,N}$  by  $s_{cr}$  and  $c_{cr}$ . The effect of a narrowly spaced reinforcement and of non-cracked concrete is taken into account by the factors  $\psi_{re}$ . The factor  $\psi_{re}$  is calculated according to 5.2.2.4 d).

In case of shear load with lever arm the characteristic anchor resistance shall be calculated according to Equation (5.5), replacing  $N_{Rd,s}$  by  $F_{Rd}^0$  in Equation (5.5a).

The smallest of the values  $F_{Rd}$  according to Equation (5.10) or  $V_{Rk,s}/\gamma_{Ms}$  according to Equation (5.5) governs.

## 5.4 Design method C

Design method C is based on a simplified approach in which only one value for the design resistance  $F_{Rd}$  is given, independent of loading direction and mode of failure. The actual spacing and edge distance shall be equal to or larger than the values of  $s_{cr}$  and  $c_{cr}$ .  $F_{Rd}$ ,  $s_{cr}$  and  $c_{cr}$  are given in the relevant ETA.

In case of shear load with lever arm the characteristic anchor resistance shall be calculated according to Equation (5.5) replacing  $N_{Rd,s}$  by  $F_{Rd}$  in Equation (5.5a).

The smallest value of  $F_{Rd}$  or  $V_{Rk,s}/\gamma_{Ms}$  according to Equation (5.5) governs.

## 6 Serviceability limit state

### 6.1 Displacements

The characteristic displacement of the anchor under defined tension and shear loads shall be taken from the ETA. It may be assumed that the displacements are a linear function of the applied load. In case of a combined tension and shear load, the displacements for the tension and shear component of the resultant load shall be geometrically added.

In case of shear loads the influence of the hole clearance in the fixture on the expected displacement of the whole anchorage shall be taken into account.

### 6.2 Shear load with changing sign

If the shear loads acting on the anchor change their sign several times, appropriate measures shall be taken to avoid a fatigue failure of the anchor steel (e.g. the shear load should be transferred by friction between the fixture and the concrete (e.g. due to a sufficiently high permanent prestressing force)).

Shear loads with changing sign can occur due to temperature variations in the fastened member (e.g. facade elements). Therefore, either these members are anchored such that no significant shear loads due to the restraint of deformations imposed to the fastened element will occur in the anchor or in shear loading with lever arm (stand-off installation) the bending stresses in the most stressed anchor  $\Delta\sigma = \max\sigma - \min\sigma$  in the serviceability limit state caused by temperature variations should be limited to  $100 \text{ N/mm}^2$ .

## 7 Additional proofs for ensuring the characteristic resistance of concrete member

### 7.1 General

The proof of the local transmission of the anchor loads into the concrete member is delivered by using the design methods described in this document.

The transmission of the anchor loads to the supports of the concrete member shall be shown for the ultimate limit state and the serviceability limit state; for this purpose, the normal verifications shall be carried out under due consideration of the actions introduced by the anchors. For these verifications the additional provisions given in 7.2 and 7.3 shall be taken into account.

If the edge distance of an anchor is smaller than the characteristic edge distance  $c_{cr,N}$  (design method A) or  $c_{cr}$  (design methods B and C), then a longitudinal reinforcement of at least  $\varnothing 6$  shall be provided at the edge of the member in the area of the anchorage depth.

In case of slabs and beams made out of prefabricated units and added cast-in-place concrete, anchor loads may be transmitted into the prefabricated concrete only if the precast concrete is connected to the cast-in-place concrete by a shear reinforcement. If this shear reinforcement between precast and cast-in-place concrete is not present, the anchors shall either be embedded with hef in the added concrete, or only the loads of suspended ceilings or similar constructions with a load up to  $1.0 \text{ kN/m}^2$  may be anchored in the precast concrete.



## 7.2 Shear resistance of concrete member

In general, the shear forces  $V_{Sd,a}$  caused by anchor loads shall not exceed the value

$$V_{Sd,a} = 0.4 V_{Rd1} \quad (7.1)$$

where  $V_{Rd1}$  = shear resistance according Eurocode No. 2 [1]

When calculating  $V_{Sd,a}$  the anchor loads shall be assumed as point loads with a width of load application  $t_1 = s_{t1} + 2 h_{ef}$  and  $t_2 = s_{t2} + 2 h_{ef}$ , with  $s_{t1}$  ( $s_{t2}$ ) spacing between the outer anchors of a group in direction 1 (2). The active width over which the shear force is transmitted should be calculated according to the theory of elasticity.

Equation (7.1) may be neglected, if one of the following conditions is met

**a)** The shear force  $V_{Sd}$  at the support caused by the design actions including the anchor loads is

$$V_{Sd} \leq 0.8 V_{Rd1} \quad (7.2)$$

**b)** Under the characteristic actions, the resultant tension force,  $N_{Sk}$ , of the tensioned fasteners is  $N_{Sk,k} \leq 30$  kN and the spacing,  $a$ , between the outermost anchors of adjacent groups or between the outer anchors of a group and individual anchors satisfies Equation (7.3)

$$a \geq 200 \cdot \sqrt{N_{Sk}} \quad a \text{ [mm]; } N_{Sk} \text{ [kN]} \quad (7.3)$$

The anchor loads are taken up by a hanger reinforcement, which encloses the tension reinforcement and is anchored at the opposite side of the concrete member. Its distance from an individual anchor or the outermost anchors of a group shall be smaller than  $h_{ef}$

If under the characteristic actions, the resultant tension force,  $N_{Sk}$ , of the tensioned fasteners is  $N_{Sk} \geq 60$  kN, then either the embedment depth of the anchors shall be  $h_{ef} \geq 0.8 h$  or a hanger reinforcement according to paragraph c) above shall be provided.

The necessary checks for ensuring the required shear resistance of the concrete member are summarized in Table 7.1.

**Table 7.1** Necessary checks for ensuring the required shear resistance of concrete member

Calculated value of shear force of the concrete member under due consideration of the anchor loads	Spacing between single anchors and groups of anchors	$N_{Sk}$ [kN]	Proof of calculated shear force resulting from anchor loads
$V_{Sd} \leq 0.8 \cdot V_{Rd1}$	$a \geq s_{cr,N}^{1)} (s_{cr})^{2)}$	$\leq 60$	not required
$V_{Sd} > 0.8 \cdot V_{Rd1}$	$a \geq s_{cr,N}^{1)} (s_{cr})^{2)}$ and $a \geq 200 \cdot \sqrt{N_{Sk}}$	$\leq 30$	not required
		$\leq 60$	required: $V_{Sd,a} \leq 0.4 \cdot V_{Rd1}$ or hanger reinforcement or $h_{ef} \geq 0.8 h$
	$> 60$	not required, but hanger reinforcement or $h_{ef} \geq 0.8 h$	
<sup>1)</sup> Design method A <sup>2)</sup> Design methods B and C			

### 7.3 Resistance to splitting forces

In general, the splitting forces caused by anchors shall be taken into account in the design of the concrete member. This may be neglected if one of the following conditions is met:

The load transfer area is in the compression zone of the concrete member.

The tension component  $N_{Sk}$  of the characteristic loads acting on the anchorage (single anchor or group of anchors) is smaller than 10 kN.

The tension component  $N_{Sk}$  is not greater than 30 kN. In addition, for fastenings in slabs and walls a concentrated reinforcement in both directions is present in the region of the anchorage. The area of the transverse reinforcement shall be at least 60 % of the longitudinal reinforcement required for the actions due to anchor loads.

If the characteristic tension load acting on the anchorage is  $N_{Sk} \geq 30$  kN and the anchors are located in the tension zone of the concrete member, the splitting forces shall be taken up by reinforcement. As a first indication for anchors according to current experience the ratio between splitting force  $F_{Sp,k}$  and the characteristic tension load  $N_{Sk}$  or  $N_{Rd}$  (displacement controlled anchors) may be taken as

$F_{Sp,k}$	=	1.5 $N_{Sk}$	torque-controlled expansion anchors (Part 2)
	=	1.0 $N_{Sk}$	undercut anchors (Part 3)
	=	2.0 $N_{Rd}$	deformation-controlled expansion anchors (Part 4)