



EUROPEAN ASSESSMENT DOCUMENT

EAD 090120-00-0404

July 2018

KITS FOR NON-LOAD BEARING MINERAL BOARD EXTERNAL WALL SYSTEMS

The reference title and language for this EAD is English. The applicable rules of copyright refer to the document elaborated in and published by EOTA.

This European Assessment Document (EAD) has been developed taking into account up-to-date technical and scientific knowledge at the time of issue and is published in accordance with the relevant provisions of Regulation (EU) No 305/2011 as a basis for the preparation and issuing of European Technical Assessments (ETA).

Contents

1	Scope of the EAD	5
1.1	Description of the construction product	5
1.2	Information on the intended use(s) of the construction product	9
1.2.1	Intended use(s)	9
1.2.2	Working life/Durability	9
1.3	Specific terms used in this EAD (if necessary in addition to the definitions in CPR, Art 2)	10
1.3.1	External wall kit	10
1.3.2	Building envelope	10
1.3.3	Substrate	10
1.3.4	Subframe	10
1.3.5	Rendering system	10
1.3.6	Base-coat	10
1.3.7	Reinforcement mesh	10
1.3.8	Finishing coat	10
1.3.9	Board-fixing	11
1.3.10	Subframe-fixing	11
1.3.11	Ancillary materials	11
1.3.12	Breather membrane	11
1.3.13	Exterior-finishing	11
2	Essential characteristics and relevant assessment methods and criteria	12
2.1	Essential characteristics of the product	12
2.2	Methods and criteria for assessing the performance of the product in relation to essential characteristics of the product	13
2.2.1	Reaction to fire	13
2.2.2	Resistance to fire	13
2.2.3	Façade fire performance	14
2.2.4	Propensity to undergo continuous smouldering	14
2.2.5	Watertightness (protection against driving rain)	14
2.2.6	Water absorption	15
2.2.7	Water vapour permeability	16
2.2.8	Condensation risk	17
2.2.9	Air permeability	18
2.2.10	Content, emission and/or release of dangerous substances	18
2.2.11	Wind load resistance	20
2.2.12	External eccentric vertical load resistance	21
2.2.13	Internal eccentric vertical load resistance	21
2.2.14	Internal horizontal linear static load resistance	21
2.2.15	External impact resistance	22
2.2.16	Internal impact resistance	22
2.2.17	Resistance to horizontal point loads	22
2.2.18	Mechanical resistances	23
2.2.19	Airborne sound insulation	25
2.2.20	Sound absorption	25
2.2.21	Thermal resistance	25
2.2.22	Thermal inertia	26
2.2.23	Heat capacity	26
2.2.24	Durability	26
3	Assessment and verification of constancy of performance	30
3.1	System(s) of assessment and verification of constancy of performance to be applied	30
3.2	Tasks of the manufacturer	30
3.3	Tasks of the notified body	34

3.4	Special methods of control and testing used for the verification of constancy of performance	35
4	Reference documents	36
	ANNEX A – SPECIAL COMPONENTS TEST METHODS	42
	ANNEX B – REACTION TO FIRE	48
	ANNEX C – RESISTANCE TO FIRE. DIRECT APPLICATION RULES	53
	ANNEX D – FAÇADE FIRE PERFORMANCE ASSESSMENT METHODS	54
	ANNEX E – WATER ABSORPTION BY CAPILLARITY TEST	55
	ANNEX F – ADDITIONAL CRITERIA FOR WIND SUCTION AND PRESSURE LOAD TESTS	56
	ANNEX G – EXTERNAL ECCENTRIC LOAD RESISTANCE TEST	58
	ANNEX H – EXTERNAL IMPACT RESISTANCE TEST	61
	ANNEX I – RESISTANCE TO HORIZONTAL POINT LOAD	64
	ANNEX J – BOND STRENGTH TEST	65
	ANNEX K – MECHANICAL RESISTANCE OF THE CONNECTION BETWEEN THE BOARD AND THE BOARD-FIXING	67
	ANNEX L – DURABILITY	69
	ANNEX M – SEQUENCE FOR WEATHER RESISTANCE TESTS	77
	ANNEX N – ALTERNATIVE WATER PENETRATION TESTS	78
	ANNEX O – TEST RESULTS STATISTICAL DESCRIPTION	81

1 SCOPE OF THE EAD

1.1 Description of the construction product

The EAD covers the assessment of kits¹ for non-load bearing external wall systems made of mineral boards.

The EAD is applicable to the external wall kits belonging to the families given in table 1.1. They consist of the following components:

Note: the ETA should include the technical description of the external wall kit components.

1. Rendering systems applied in-situ on the external-board, only relevant for external wall kits used for complete building envelope (see section 1.2.1). The rendering system is composed of:

- finishing coat (paint or mineral mortar or organic mortar and optionally impregnation or primer);
- reinforced base-coat (mineral or organic mortar + glass fibre mesh for reinforcement).

Rendering system components are specified by the type of material, range of thickness application, water quantity ratio (if relevant), coverage and density.

2. Mineral boards (including optionally their joint treatment components). Boards according to EN 12467, EN 15283-1, EN 15283-2, EN 520, EAD 210024 or any other flat board of mineral material with their own harmonized standard or EAD as an individual component:

- External-board: mineral boards for external use, and suitable for receiving a rendering system or an exterior-finishing;
- Internal-board and intermediate-board: mineral boards for internal use.

Mineral boards are specified by the type of material, dimensions and density.

3. Board-fixings: metal screws for fixing the boards to the subframe profiles.

4. Single or double subframe (optional), composed of the following components:

- Vertical profiles made of metal materials (steel or aluminium alloy).
- Horizontal profiles to connect the vertical profiles to the building structure.
- Screws or rivets between the profiles.
- Metal anchors between the subframe and the building structure (optional).

Profiles are specified by geometric and physical parameters (such as form and dimensions, weight, cross section, distance between profiles and between brackets) and material parameters (such as type of material, specific gravity, mechanical material properties).

Screws and anchors are specified by geometric parameters (such as form and dimensions) and material parameters (such as type of material and mechanical properties).

5. Thermal insulation product (optional) with its own harmonized standard or EAD as an individual component.

Thermal insulation products are specified by the type of material, dimensions, density or weight per square meter and water absorption.

6. Breather membrane (optional):

¹ Definition of "Kit" according to Art. 2 n° 2 of CPR. The components are assembled on site, and thus, become an "assembled kit" when installed in the construction works.

- flexible sheet for waterproofing;
 - flexible sheet or sheet included in the board for vapour control.
7. Other ancillary components (optional). Any other component used in the kit (e.g. to form joints such as sealant, corner strips, etc.; or to achieve continuity such as mastic, joint-covers, gaskets, trims, etc.).

Breather membrane and other ancillary components are specified by geometric parameters (such as form and dimensions) and material parameters (such as type of material, mechanical properties).

Table 1.2 indicates the materials and harmonized specifications related with these components.

The rendering system components can include a range of binders from pure polymeric to pure cementitious. They can be available in the following forms:

- powder (dry mortar) blended at the factory that requires only mixing with a quantity of water specified by the manufacturer;
- powder requiring addition of extra binder;
- paste requiring addition of cement;
- ready to use paste, supplied in workable consistency.

The manufacturer can provide:

- a complete kit: mineral boards, board-fixings, subframe components, rendering system (for use 1, see section 1.2.1) and optionally, breather membrane, thermal insulation product and other ancillary components;
- a minimum kit: mineral boards, board-fixings and rendering system (for use 1, see section 1.2.1) or;
- a partial kit (minimum kit and other external wall system components but not a complete kit).

The external wall kits covered by this EAD always include the boards (mineral board and board-fixings). When the boards are not provided by the manufacturer this EAD does not apply and, then, the kit may be covered by a specific EAD.

The external walls covered by this EAD are non load-bearing construction elements. They do not contribute to the stability of the structure on which they are installed.

The product is not fully covered by:

- EN 13830 Curtain walling, because the subframe of the external wall is installed between the structural floors. In a curtain walling the subframe passes in front of the structural floors. In addition, curtain walling is usually composed of glass or composite panels assembled in one layer.
- EAD 210005 (ETAG 003 conversion) Internal Partition Kits (IPK), because the scope of this document is only for internal uses.

Note: The harmonized technical specifications given in table 1.2 do not cover similar products (kits) but just individual components.

Concerning product packaging, transport, storage, maintenance, replacement and repair it is the responsibility of the manufacturer to undertake the appropriate measures and to advise its clients on the transport, storage, maintenance, replacement and repair of the product as it considers necessary.

It is assumed that the product will be installed according to the manufacturer's instructions or (in absence of such instructions) according to the usual practice of the building professionals.

Relevant manufacturer's stipulations having influence on the performance of the product covered by this European Assessment Document shall be considered for the determination of the performance and detailed in the ETA.

Table 1.1: Description of the external wall kit families.

Family of external wall kits	Description of the external wall kit	Figure
Family 1	Kits for single wall without horizontal profile.	(see figures 1.1)
Family 2	Kits for single wall with additional internal horizontal profile.	(see figures 1.2)
Family 3	Kits for double wall without intermediate board.	(see figures 1.3)
Family 4	Kits for double wall with intermediate board.	(see figures 1.4)

Family 1		Family 2	
			
			
Vertical section (connection with structural floor)	Vertical section (connection with structural floor)	Vertical section (connection with structural floor)	Vertical section (connection with structural floor)
			
Horizontal section	Horizontal section	Horizontal section	Horizontal section

Figure 1.1a:
Complete external wall
(Use 1).

Figure 1.1b:
Substrate of exterior-
finishing (Use 2).

Figure 1.2a:
Complete external wall
(Use 1).

Figure 1.2b:
Substrate of exterior-
finishing (Use 2).

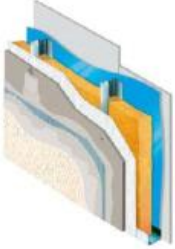
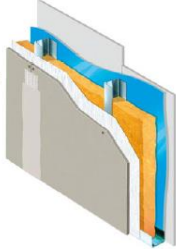
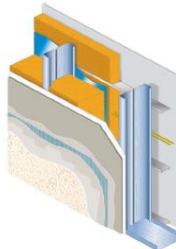
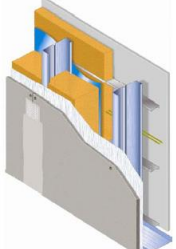
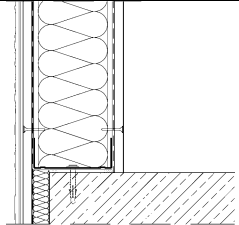
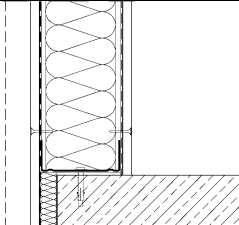
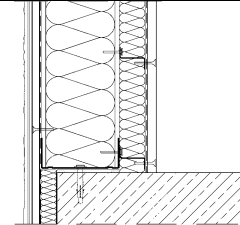
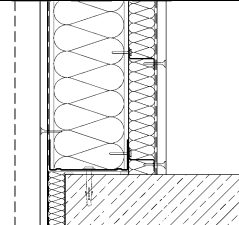
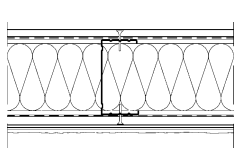
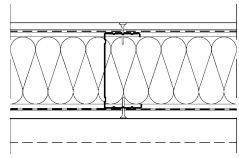
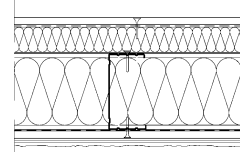
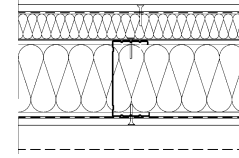
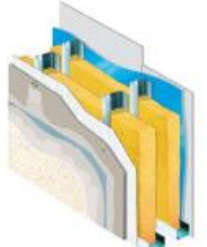
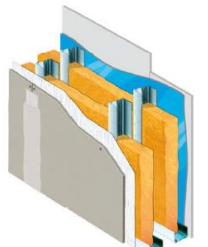
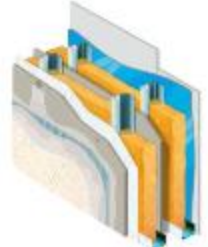
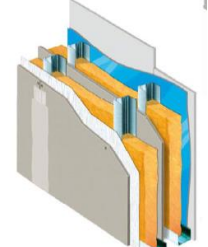
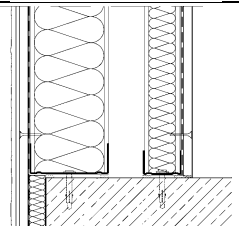
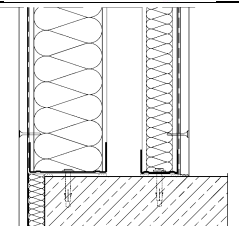
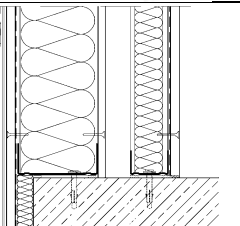
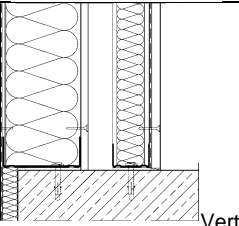
Family 3		Family 4	
			
			
Vertical section (connection with structural floor)	Vertical section (connection with structural floor)	Vertical section (connection with structural floor)	Vertical section (connection with structural floor)

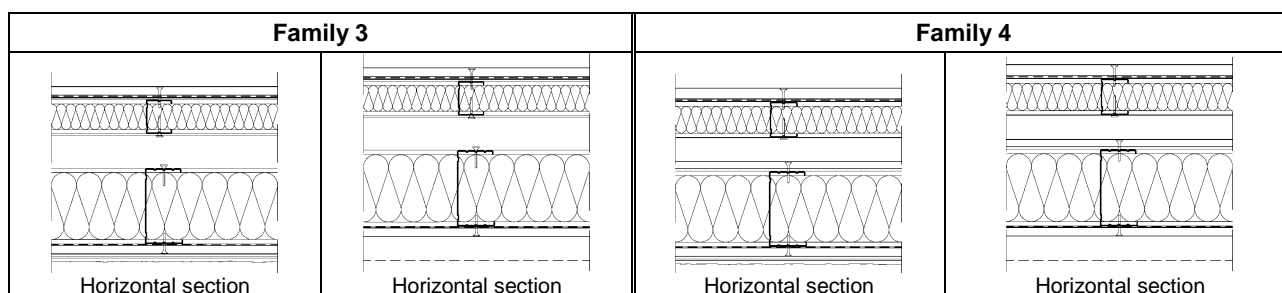

Figure 1.3a:
Complete external wall
(Use 1).

Figure 1.3b:
Substrate wall of exterior-
finishing (Use 2).

Figure 1.4a:
Complete external wall
(Use 1).

Figure 1.4b:
Substrate wall of exterior-
finishing (Use 2).

Table 1.2: Kit components and associated product technical specifications.

Part of the assembled kit	Designation	Generic component	Possible associated component technical specifications	
			Harmonized (hEN or EAD) (*)	Other references
Rendering system (for Use 1, see section 1.2.1)	Finishing coat	Mineral mortar	EN 998-1	---
		Organic mortar	EN 15824	---
		Paint	---	EN 1062-1
		Primer / Impregnation	---	EN 1062-1
	Base-coat	Mineral mortar	EN 998-1	---
		Organic mortar	EN 15824	---
	Reinforcement mesh	EAD 040016	EN 13496	
External, intermediate or internal layer	External-board Internal-board Intermediate-board	Mineral board	EN 12467; EN 15283-1; EN 15283-2; EN 520; EAD 210024	---
		Joint treatment	Joint filler (optional)	EN 998-1; EN 15824; EN 13963
		Joint tape (optional)	EAD 040016; N 13963	EN 13496
	Board-fixing	Screw	EN 14566	---
	Breather membrane	Flexible sheet for waterproofing	EN 13859-2	---
		Flexible sheet for vapour control	EN 13984	---
		Vapour control sheet included in the board	EN 14190	---
Subframe	Profiles	Vertical profile (e.g. C-profile)	EN 14195	EN 1993 EN 1999
		Horizontal profile (e.g. U-profile, Ω -profile, Z-profile)		
	Subframe-fixing	Screw	EN 14566	EN ISO 3506-x
		Rivets	---	EN ISO 15973 to 15984; EN ISO 16582 to 16585
	Anchor to building structure	Metal anchor for use in concrete	EAD 330747 (ETAG 001 part 6); EAD 330232	---
		Bonded fasteners for use in concrete	EAD 330499	---

Table 1.2: Kit components and associated product technical specifications.

Part of the assembled kit	Designation	Generic component	Possible associated component technical specifications	
			Harmonized (hEN or EAD) (*)	Other references
		Metal anchor for use in other materials	---	EN 15048-1 EN 14399-1
		Plastic anchor	EAD 330284 (ETAG 020)	---
Thermal insulation	Factory made thermal insulation panels	MW; EPS; XPS; PUR; PF; Other materials	EN 13162; EN 13163; EN 13164; EN 13165; EN 13166; relevant hEN or EAD	---
(*) Other harmonized specifications applicable to these components may be used.				

1.2 Information on the intended use(s) of the construction product

1.2.1 Intended use(s)

This EAD covers the following intended uses:

- Use 1: Complete building envelope in non-ventilated façades.
- Use 2: Substrate wall support of exterior-finishing (bonded and/or mechanically fixed, e.g. claddings, ETICS, etc.) in ventilated and non-ventilated façades. In this case, the exterior-finishing of the external wall is not part of the kit and therefore this EAD does not cover the assessment of the exterior-finishing or the assessment for the use as complete building envelope (with exposition to external weather conditions).

This EAD does not cover the assessment of the external wall kits under the effects of seismic actions.

1.2.2 Working life/Durability

The assessment methods included or referred to in this EAD have been written based on the manufacturer's request to take into account a working life of the external wall kit for the intended use of 25 years when installed in the works. These provisions are based upon the current state of the art and the available knowledge and experience.

When assessing the product, the intended use as foreseen by the manufacturer shall be taken into account. The real working life may be, in normal use conditions, considerably longer without major degradation affecting the basic requirements for works².

The indications given as to the working life of the construction product cannot be interpreted as a guarantee neither given by the product manufacturer or its representative nor by EOTA when drafting this EAD nor by the Technical Assessment Body issuing an ETA based on this EAD, but are regarded only as a means for expressing the expected economically reasonable working life of the product.

² The real working life of a product incorporated in a specific works depends on the environmental conditions to which that works is subject, as well as on the particular conditions of the design, execution, use and maintenance of that works. Therefore, it cannot be excluded that in certain cases the real working life of the product may also be shorter than referred to above.

1.3 Specific terms used in this EAD (if necessary in addition to the definitions in CPR, Art 2)

1.3.1 External wall kit

An external wall kit is a specific kit¹ for the execution of external wall systems that meet the necessary airtightness and mechanical strength requirements (resistance to static and dynamic loads), as well as a relevant watertightness and water vapour resistance.

1.3.2 Building envelope

Part of the building which separates the internal environment from the external environment.

1.3.3 Substrate

The term “substrate” refers to the wall on which the exterior-finishing is applied or fixed.

1.3.4 Subframe

An assembly of vertical and/or horizontal metal profiles (including the fixings between them) which supports the mineral boards.

1.3.5 Rendering system

The term “rendering system” refers to the layer composed by the base-coat (see 1.3.6) and the finishing coat (see 1.3.8).

1.3.6 Base-coat

Coat (mortar) applied directly onto the board; the reinforcement mesh is embedded into it to provide most of the mechanical properties of the rendering system.

1.3.7 Reinforcement mesh

Glass fibre mesh (embedded) in the base-coat to improve its mechanical strength.

1.3.8 Finishing coat

Coat applied onto the base-coat which contributes to the protection against weathering and to the aesthetic finishing.

The finishing coat can be composed by one of these options:

- Mineral or organic mortar with or without primer (see 1.3.8.1) and with or without “coating” (see 1.3.8.2).
- Coating (see 1.3.8.2) applied directly onto the base-coat without the organic or mineral mortar.

1.3.8.1 Primer (or key coat)

A very thin coat which can be applied onto the base-coat and it is intended to act as a preparation for the application of the finishing coat (mineral mortar, organic mortar or coating, see 1.3.8).

1.3.8.2 Coating

A coat composed by a paint or an impregnation (see 1.3.8.3) that may be applied directly onto the base-coat or onto the mortar.

1.3.8.3 Impregnation

A water-based fluid with hydrophobizer which reduce the water absorption of the surface (e.g. from rain). It also reduces significantly façade discoloration from rain.

1.3.9 Board-fixing

Screws used to secure the board to the subframe.

1.3.10 Subframe-fixing

Screws or rivets used to fasten the subframe components.

1.3.11 Ancillary materials

Any supplementary component used in the kit (e.g. to form joints such as sealant, corner strips, etc.; or to achieve continuity such as mastic, joint-covers, gaskets, trims, etc.).

1.3.12 Breather membrane

Membrane placed in the external wall kit which contributes to the watertightness or to the vapour control of the wall.

1.3.13 Exterior-finishing

The term “exterior-finishing” refers to the exterior covering to be supported by the external wall kit when the use is for substrate wall (use 2 according to section 1.2.1).

2 ESSENTIAL CHARACTERISTICS AND RELEVANT ASSESSMENT METHODS AND CRITERIA

2.1 Essential characteristics of the product

Table 2.1 shows how the performance of external wall kit is assessed in relation to the essential characteristics.

Table 2.1: Essential characteristics of the product and methods and criteria for assessing the performance of the product in relation to those essential characteristics.

No	Essential characteristic		Assessment method	Type of expression of product performance	
Basic Works Requirement 2: Safety in case of fire					
1	Reaction to fire		2.2.1	Class	
2	Resistance to fire		2.2.2	Class	
3	Façade Fire Performance		2.2.3	Description or Level	
4	Propensity to undergo continuous smouldering		2.2.4	Description	
Basic Works Requirement 3: Hygiene, health and the environment					
5	Watertightness (protection against driving rain)		2.2.5	Description or Level	
6	Water absorption (*)		2.2.6	Level	
7	Water vapour permeability (*)		2.2.7	Level	
8	Condensation risk		2.2.8	Description	
9	Air permeability		2.2.9	Level	
10	Content, emission and/or release of dangerous substances		2.2.10	Description	
Basic Works Requirement 4: Safety and accessibility in use					
11	Wind load resistance		2.2.11	Level	
12	External eccentric vertical load resistance (for use 2)		2.2.12	Level	
13	Internal eccentric vertical load resistance (*)		2.2.13	Level	
14	Internal horizontal linear static load resistance (*)		2.2.14	Level	
15	External impact resistance		2.2.15	Level	
16	Internal impact resistance (*)		2.2.16	Level	
17	Resistance to horizontal point loads (for use 1)		2.2.17	Description	
18	Mechanical resistance (**)	Bond strength (adhesion between the rendering system and the board)	2.2.18.1	Level	
19		Bending strength of the board	2.2.18.2	Level	
20		Connection (board-fixing-subframe)	Embedding / Shear strength	2.2.18.3	Level
21			Pull-through / pull-out resistance	2.2.18.4	Level
22		Resistance of profiles	2.2.18.5	Description	
Basic Works Requirement 5: Protection against noise					
23	Airborne sound insulation		2.2.19	Level	
24	Sound absorption		2.2.20	Level	
Basic Works Requirement 6: Energy economy and heat retention					
25	Thermal resistance		2.2.21	Level	
26	Thermal inertia		2.2.22	Level	
27	Heat capacity		2.2.23	Level	

Table 2.1: Essential characteristics of the product and methods and criteria for assessing the performance of the product in relation to those essential characteristics.

No	Essential characteristic	Assessment method	Type of expression of product performance
Durability (***)			
28	Accelerated ageing behaviour	2.2.24.1	Description and Level
29	Cracking strength due to board deformation	2.2.24.2	Level
30	Dimensional stability (*):	2.2.24.3	Level
	by humidity		
	by temperature		
31	Moisture content (*)	2.2.24.4	Level
32	Corrosion	2.2.24.5	Description
33	UV radiation resistance (*)	2.2.24.6	Level
(*) When available, performance included in the DoP for the CE marking as individual component or as IPK should be used as far as possible to avoid retesting or reassessment.			
(**) Mechanical resistance of the kit is assessed by means of the mechanical characteristics of the relevant kit components. See section 2.2.18.			
(***) Durability of the kit is assessed by means of relevant component durability, when relevant. See section 2.2.24.			

2.2 Methods and criteria for assessing the performance of the product in relation to essential characteristics of the product

2.2.1 Reaction to fire

Reaction to fire of the whole kit shall be assessed by considering the reaction to fire of the components (rendering system components, boards, board-fixings, subframe components, breather membranes, thermal insulation products, etc.), in order to be classified according to Commission Delegated Regulation (EU) 2016/364.

The whole kit shall be classified based on the worst class of any component obtained according to a CWFT Decisions or according to the relevant tests method(s) according to EN 13501-1.

Otherwise, the external wall kit shall be tested, using the test method(s) according to EN 13501-1 relevant for the corresponding reaction to fire class, in order to be classified according to the Commission Delegated Regulation (EU) 2016/364.

Criteria given in Annex B shall be taken into account. Associated mounting and fixing rules for the SBI test shall be in accordance with the relevant harmonized specifications of the boards (see table 1.2).

2.2.2 Resistance to fire

Resistance to fire of the external wall kit shall be tested according to EN 1364-1 in order to be classified according to EN 13501-2.

At least the worst case (e.g. minimum thicknesses, the mechanically weakest wall, etc.) or the most representative case of the assembled kit shall be considered.

Concerning mounting and fixing rules and direct application rules for resistance to fire, see Annex C.

Due of the asymmetry of the systems, the manufacturer and TAB should decide if the assembled kit will be tested with the external layer, the internal layer or both layers directly exposed to the fire.

2.2.3 Façade fire performance

If the manufacturer intends to declare the façade fire performance of the product, in absence of a European assessment approach, the ETA shall be issued taking into account the situation in Member States where the manufacturer intends his product to be made available on the market.

Information on such situation is included in Annex D.

The assessment method(s) used shall be indicated in the ETA.

2.2.4 Propensity to undergo continuous smouldering

This characteristic is only applicable for cladding kits which include the thermal insulation product (see section 1.1) made of mineral wool (MW), wood wool (WW), cork, wood fibres (WF) or made of any other vegetal or animal fibres.

The assessment of the kit propensity to undergo continuous smouldering is carried out by means of the assessment of the propensity to undergo continuous smouldering of the thermal insulation product which is representative of this essential characteristic for external wall kits.

Propensity to undergo continuous smouldering of thermal insulation product shall be assessed according to the EN 16733.

Note: When available, performance included in the DoP regarding the thermal insulation product should be used as far as possible to avoid retesting or reassessment.

Description of propensity to undergo continuous smouldering shall be given in the ETA according to section 11 of EN 16733.

2.2.5 Watertightness (protection against driving rain)

In the case of kits (with rendering system included) used for complete building envelopes in non-ventilated façades (Use 1 according to section 1.2.1):

The watertightness of the external wall kit may be tested according to EN 12865 Procedure A or EN 12155. See also the test sequence given in Annex M.

Alternatively, for the use of the kit in zones with pressure conditions of driving rain more severe than those given in EN 12865 or EN 12155, the watertightness of the external wall kit may be assessed according to the method given in Annex N.

At least the worst case (e.g. rendering system with greater water absorption, minimum thicknesses, without breather membrane, etc.) or the most representative case of the assembled kit shall be considered.

In order to obtain a good observation of the water penetration, it is possible to carry out the test only with the external partial composition of the assembled kit (e.g. external subframe, external-board, the rendering system and, optionally the flexible sheet for waterproofing).

Taking into account the results of the analysis of the construction details of the openings of the façade, the manufacturer and the TAB may decide to include a generic opening in the test specimen in order to analyse the watertightness of the joints between the openings and the assembled kit.

The dimensions of the test specimen depend on the assembled kit (the span between structural floors and the span between vertical profiles). At least, one maximum span between structural floors and three vertical profiles (two spans between profiles) must be tested. The assembled kit must be fixed to the test equipment. As reference, the dimensions of the test specimen, given in section L.1 of Annex L for the hygrothermal behaviour test, may be used.

In the case to include a generic opening, the position and dimensions may also be the given in section L.1 of Annex L. The generic opening shall not be a weak point and shall therefore be chosen accordingly. At

least, the generic opening to be used in the test must have a watertightness classification higher than the maximum test pressure estimated for the assembled kit test.

The limit level of pressure (e.g. just before water penetration) shall be given according to EN 12865 or EN 12154 (when the test according to EN 12155 is considered).

Alternatively, when the kit is assessed according to Annex N, both the limit level of pressure according to EN 12865 and the description of the exposure zone according to table N.2 of Annex N shall be given.

In the case of kits without rendering system used as substrate of exterior-finishing in non-ventilated and ventilated façades (Use 2 according to section 1.2.1):

External wall kits intended to be used with an exterior-finishing defined as “watertight” shall be described as “for use with watertight exterior-finishing”.

External wall kits intended to be used with an exterior-finishing defined as “not watertight” (e.g. cladding kits with open joints) or when the manufacturer specifically requires it (in the case of “watertight exterior-finishing”), the assessment of the external wall kit shall be carried out as indicated previously for kits (with rendering system included) considering the use of specific exterior-finishing materials. In this case, the performance of the kit stated in the ETA applies only to configurations as used in ETA process.

2.2.6 Water absorption

The assessment of the kit water absorption is carried out by means of the assessment of the water absorption of the relevant kit components (rendering system, boards and, when relevant, the watertightness of the breather membrane), which are representative of this essential characteristic for the kit.

Water absorption is also considered for:

- the assessment of the watertightness (see section 2.2.4).
- the needing to carry out the freeze-thaw resistance test (see section 2.2.24.1).

2.2.6.1 Water absorption by capillarity

This characteristic is only relevant when the kit includes the rendering system and it is used for complete building envelopes in non-ventilated façades.

Water absorption by capillarity shall be tested according to Annex E.

Testing shall be carried out:

- for the whole rendering system (finishing coat and base-coat with the reinforcement mesh) to be considered in the ETA, and
- for the reinforced base-coat alone.

The test specimens shall be prepared with the board as the substrate. The edges of test specimens shall be protected to ensure that only the rendering system or the reinforced base-coat is subject to water absorption.

Only the rendering system or reinforced base-coat of the test specimens must be submerged in a water bath.

When relevant, the test specimens shall be prepared at the same time that:

- the rig for the hygrothermal behaviour test (see section 2.2.24.1), and
- the samples for freeze-thaw resistance test (see section 2.2.24.1).

Mean³ values of water absorption (in kg/m²) after 3 minutes, 1 hour and 24 hours of the kit (with and without the finishing coat) shall be given.

³ The mean value is the arithmetic average value.

2.2.6.2 Water permeability (water column)

This characteristic is only relevant when the kit includes the rendering system and it is used for complete building envelopes in non-ventilated façades.

Water penetration resistance due to hydrostatic pressure of the rendering system shall be tested according to section 7.1 of EN 1015-21 (without the conditioning cycles given in section 6.3 of EN 1015-21).

Testing shall be carried out for each rendering system (finishing coat and base-coat with the reinforcement mesh) to be considered in the ETA.

The test specimens shall be prepared with the board as the substrate. If relevant, the flexible sheet for waterproofing could also be used in the test specimen.

When relevant, the test specimens shall be prepared at the same time that:

- the rig for the hygrothermal behaviour test (see section 2.2.24.1), and
- the samples for freeze-thaw test (see section 2.2.24.1).

The mean³ value and the maximum value shall be given.

2.2.6.3 Water absorption of the board

This characteristic is only relevant for external-boards.

Water absorption (partial and/or fully immersed) of the board shall be assessed according to the relevant hEN (see table 1.2) or EAD.

Note: When available, performance included in the DoP regarding the external-board should be used as far as possible to avoid retesting or reassessment.

When the hEN or EAD does not give an assessment method, the water absorption of the board shall be assessed according to sections 5.9.1 and 5.9.2 of EN 520.

The mean³ value and the maximum value shall be given.

The values shall cover the range of density of the board.

2.2.6.4 Watertightness of the breather membrane

This characteristic is only relevant when the kit includes the breather membrane for watertightness.

Watertightness of the breather membrane shall be assessed according to EN 13859-2.

Note: When available, performance included in the DoP regarding the breather membrane be used as far as possible to avoid retesting or reassessment.

2.2.7 Water vapour permeability

The assessment of the kit water vapour permeability is carried out by means of the assessment of the water vapour permeability of the relevant kit components (rendering system, board, thermal insulation product and breather membrane) representative of this essential characteristic for external wall kits.

Water vapour permeability of the kit components shall be assessed according to the relevant hEN (see table 1.2) or EAD.

Note: When available, performance included in the DoP regarding the relevant kit components should be used as far as possible to avoid retesting or reassessment.

When the hEN or EAD does not give an assessment method, the water vapour permeability of the relevant kit components shall be tested according to EN ISO 12572. Tabulated values according to EN ISO 10456 may also be defined by the manufacturer.

For organic mortar or paint EN ISO 7783 may also be considered.

In the case of the rendering system, a test for the whole rendering system (including the reinforced mesh) is recommended.

The values shall be given according to the relevant technical specification.

2.2.8 Condensation risk

In the case of kits (with rendering system included) used for complete building envelopes in non-ventilated façades (Use 1 according to section 1.2.1)

The condensation risk of the external wall kit shall be calculated according to EN ISO 13788 taking into account the climatic conditions. This standard includes information on the assessment of the risk of mould growth. The assessment shall be completed by the analysis of the construction details in singular points (e.g. connections with openings, connections with floors, etc.).

The assessment is to be undertaken considering both interstitial and internal surface condensation.

At least the worst case or the most representative case of the assembled kit shall be considered.

For the calculation the following data are to be considered:

- water vapour permeability of the kit components (see section 2.2.7);
- thermal resistance of the kit components;
- the critical composition of the assembled kit.

It should be noted that the permeability of some materials can vary depending on whether they are drying up (absorption) or drying down (desorption) in an environment (hysteresis effects). This should be considered, particularly when using design values.

In addition, the design of joints and the fixings penetrating any vapour control membrane shall be assessed in relation to the risk of airborne moisture meeting cold surfaces within the wall.

The condensation risk shall be described as one of the following terms and also given the climatic conditions considered in the calculation:

- **No Risk:** when both, the interstitial and the internal surface condensation do not occur or when it occurs only to an extent where damage is not caused during the condensation period and when the external wall system will dry out again during the evaporation period.
- **Risk:** when the interstitial or the internal surface condensation occurs.

In the case of kits without rendering system used as substrate of exterior-finishing in non-ventilated and ventilated façades (Use 2 according to section 1.2.1)

Taking into account the exterior-finishing intended to be used together with the kit, there are two possibilities:

- 1) In the case of ventilated façades, the assessment of the external wall kit shall be carried out as indicated previously for kits for Use 1 according to section 1.2.1).
- 2) In the case of non-ventilated façades, the exterior-finishing contributes to the condensation risk of the external wall, therefore, the condensation risk of the external wall kit may be described either as:
 - “Not relevant, condensation risk depends on the exterior-finishing” or,
 - when the manufacturer requires it, it is possible to carry out the assessment, as indicated previously for kits for Use 1 according to section 1.2.1), considering the use of specific exterior-finishing materials. In this case, the performance of the kit stated in the ETA applies only to configurations as used in the ETA process.

2.2.9 Air permeability

The air permeability of the external wall kit shall be tested according to EN 12153. See also the test sequence given in Annex M.

At least the worst case (e.g. without rendering system, minimum thicknesses, maximum number of joints, without breather membrane, etc.) or the most representative case of the assembled kit shall be considered.

It is possible to carry out the test only with the external partial composition of the assembled kit (e.g. external subframe, external-board, etc.).

Taking into account the results of the analysis of the construction details of the openings of the façade, the manufacturer and the TAB may decide to include a generic opening in the test specimen in order to analyse the watertightness of the joints between the openings and the assembled kit.

The dimensions of the test specimen depend on the assembled kit (the span between structural floors and the span between vertical profiles). At least, one maximum span between structural floors and three vertical profiles (two spans between profiles) must be tested. As reference, the dimensions of the test specimen, given in section L.1 of Annex L for the hygrothermal behaviour test, may be used.

In the case including a generic opening, the position and dimensions may also be those given in section L.1 of Annex L. The generic opening shall not be a weak point and shall therefore be chosen accordingly. At least, the generic opening to be used in the test must have an air permeability classification higher than the maximum test pressure estimated for the assembled kit test.

The assembled kit must be fixed to the test equipment with the worst or the most representative anchors (e.g. minimum diameter and maximum distance between them).

Test result of the air permeability based on the total area according to EN 12152 shall be given.

2.2.10 Content, emission and/or release of dangerous substances

The performance of the kit related to the emission and/or release and, where appropriate, the content of dangerous substances will be assessed on the basis of the information provided by the manufacturer⁴ after identifying the release scenarios (in accordance with EOTA TR 034) taking into account the intended use of the product and the Member States where the manufacturer intends his product to be made available on the market.

The identified intended release scenario for this product and intended use with respect to dangerous substances is:

I/A1: Direct contact to indoor air.

I/A2: Indirect contact to indoor air.

SW2: Product with indirect contact to soil, ground- and surface water.

2.2.10.1 SVOC and VOC

For the intended uses covered by the release scenarios I/A1 and I/A2, semi-volatile organic compounds (SVOC) and volatile organic compounds (VOC) shall be determined in accordance with EN 16516. The loading factor to be used for emission testing is 1 m²/m³ (intended use: walls).

⁴ The manufacturer may be asked to provide to the TAB the REACH related information which he must accompany the DoP with (cf. Article 6(5) of Regulation (EU) No 305/2011).

The manufacturer is **not** obliged:

- to provide the chemical constitution and composition of the product (or of constituents of the product) to the TAB, or
- to provide a written declaration to the TAB stating whether the product (or constituents of the product) contain(s) substances which are classified as dangerous according to Directive 67/548/EEC and Regulation (EC) No 1272/2008 and listed in the "Indicative list on dangerous substances" of the SGDS.

Any information provided by the manufacturer regarding the chemical composition of the products may not be distributed to EOTA or to TABs.

The SVOC and VOC assessment of the relevant kit components (internal-boards), shall be assessed according to the relevant hEN (see table 1.2) or EAD.

Note: When available, performance included in the DoP regarding the internal-board should be used as far as possible to avoid retesting or reassessment.

When the hEN or EAD does not give an assessment method or when there is no relevant hEN or EAD, SVOC and VOC assessment shall be assessed according to the following method:

The preparation of the test specimen is performed by using the components of the kit related to SVOC and VOC emissions (internal-boards), installed in accordance with the manufacturer's product installation instructions or (in absence of such instructions) the usual practice of installation.

Once the component test specimen is produced, it should immediately be placed in the emission test chamber. This time is considered the starting time of the emission test.

The test results have to be reported for the relevant parameters (e.g. chamber size, temperature and relative humidity, air exchange rate, loading factor, size of test specimen, conditioning, production date, arrival date, test period, test result) after 3 and 28 days testing.

The relevant test results shall be expressed in [mg/m³] and stated in the ETA.

2.2.10.2 Leachable substances

For the intended use covered by the release scenario S/W2, the performance of the kit concerning leachable substances has to be assessed.

The dangerous substances assessment of the kit is carried out by means of the assessment of the most relevant kit components materials, which are: the mineral board and the rendering system components materials.

The leachable substances assessment of the kit components materials shall be assessed according to the relevant hEN (see table 1.2) or EAD.

Note: When available, performance included in the DoP regarding the relevant kit components should be used as far as possible to avoid retesting or reassessment.

When the hEN or EAD does not give an assessment method or when there is no relevant hEN or EAD, leachable substances assessment of the kit components materials shall be assessed according to the following methods:

For mineral boards or rendering system components made of cement-based materials:

A leaching test with subsequent eluate analysis must take place, each in duplicate. Leaching tests of the mineral board or rendering system components conducted according to CEN/TS 16637-2:2014, but considering the steps below indicated for the leachant renewal. The leachant shall be pH-neutral demineralised water and the ratio of liquid volume to surface area must be (80 ± 10) l/m².

Samples shall be prepared according to clause 8.2 of CEN/TS 16637-2:2014.

The eluate is produced by a tank test according to CEN/TS 16637-2. The eluates taken after 6 hours, 1 day, 2 days and 6 hours, 4 days, 9 days, 16 days, 36 days and 64 days shall be analysed for the following environmentally relevant parameters:

- aluminium, antimony, arsenic, barium, lead, cadmium, chromium (total), chromate (Cr VI), cyanide (total), cobalt, copper, molybdenum, nickel, mercury, thallium, vanadium, zinc,
- chloride (Cl⁻), sulphate (SO₄²⁻), fluoride (F⁻),
- TOC,
- pH-value, electrical conductivity, odour, colour, turbidity, and tendency to produce foam

The parameters shall be analysed using an appropriate equipment with a measurement range allowing the measurement of the substance concentration.

Measured concentration of the leaching test according to CEN/TS 16637-2 of these kit components must be expressed per step for each parameter in µg/l and mg/m². Additionally, the cumulatively released quantities must be expressed for each parameter in mg/m².

The used test methods for the analysis of the parameters shall be documented, including the equipment and its measurement range.

For mineral boards or rendering system components materials other than cement-based covered by CEN/TS 16637-2:

A leaching test with subsequent eluate analysis must take place, each in duplicate. Leaching tests of the mineral board or rendering system components conducted according to CEN/TS 16637-2:2014. The leachant shall be pH-neutral demineralised water and the ratio of liquid volume to surface area must be (80 ± 10) l/m².

Samples shall be prepared according to clause 8.2 of CEN/TS 16637-2:2014.

In eluates of "6 hours" and "64 days", the following biological tests shall be conducted:

- Acute toxicity test with *Daphnia magna* Straus according to EN ISO 6341
- Toxicity test with algae according to ISO 15799
- Luminescent bacteria test according to EN ISO 11348-1, EN ISO 11348-2 or EN ISO 11348-3.

For each biological test, EC20-values shall be determined for dilution ratios 1:2, 1:4, 1:6, 1:8 and 1:16.

If the parameter TOC is higher than 10 mg/l, the following biological tests shall be conducted with the eluates of "6 hours" and/or "64 days" eluates:

- Biological degradation according to OECD Test Guideline 301 part A, B or E.

Determined toxicity in biological tests must be expressed as EC20-values for each dilution ratio. Maximum determined biological degradability must be expressed as "...% within ...hours/days". The respective test methods for analysis must be specified.

2.2.11 Wind load resistance

The wind load resistance (suction and/or pressure) of the kit shall be carried out by calculation taking into account the mechanical resistances of the relevant kit components (boards, board-fixings and subframe components) obtained from section 2.2.18.

At least the worst case (the mechanically weakest case) or the most representative case of the assembled kit shall be considered.

Relevant elasticity and resistance equations (beams with two supports, with uniformly distributed load or punctual loads depending on the action of the exterior-finishing) and relevant standards (e.g. EN 1999 for aluminium or EN 1993 for steel) should be considered for the calculation (at ultimate and serviceability limit state). At least for one assembled kit, the calculated result shall be contrasted by testing according to EN 12179. See also the test sequence given in Annex M.

Note: TAB will decide the relevant test (suction, pressure or both) to be carried out to assess at least the mechanically weakest case (worst case) taking into account the kit mechanical resistance (see section 2.2.18) and the specific design of the external wall kit specimen. In case of doubt, it is recommended to carry out both tests, suction and pressure.

The test specimen must be defined according the specifications given in Annex F.

It is possible to carry out the test only with the external partial composition of the assembled kit (e.g. external subframe, external-board, etc.).

In addition, when the manufacturer requires it, after carrying out the test according to EN 12179, it is possible to continue increasing the load (in steps of 200 Pa) until the test specimen fails.

The following values shall be given:

- The maximum wind load resistance “Q” for assembled external wall kit;
- The maximum deflection of the central vertical profile.

2.2.12 External eccentric vertical load resistance

This characteristic is only relevant for kits used for substrate of exterior-finishing (Use 2 as indicated in section 1.2.1).

Distinction should be done if it is expected that the exterior-finishing is mechanically fixed or bonded to the substrate wall:

- 1) In the case of the exterior-finishing mechanically fixed (e.g. cladding systems, thermal insulation products mechanically fixed, etc.), the external eccentric load resistance of the kit shall be tested according to Annex G.

When relevant, it is possible to carry out the test only with the external partial composition of the assembled kit (e.g. external subframe, external-board, etc.).

The mean³ value and the characteristic value according to Annex O shall be given.

- 2) In the case of bonded exterior-finishing (e.g. ETICS, tiling, bonded thermal insulation products, etc), the external eccentric load resistance of the kit shall be calculated considering the embedding / shear strength values (see section 2.2.18.3).

Relevant elasticity and resistance equations should be considered for the calculation (at ultimate state).

The maximum exterior-finishing weight load “P” (in kg/m²) shall be given.

At least the worst case (the mechanically weakest case) shall be assessed.

The values shall cover the range of density and thickness of the board, the range of board-fixing diameters and the range of materials and thickness of subframe profiles.

2.2.13 Internal eccentric vertical load resistance

The internal eccentric vertical load resistance of the kit shall be tested according to section 5.4.1.3 of ETAG 003 (section 2.2.6 of EAD 210005-00-0505).

Note: When available, performance included in the DoP regarding the Internal Partition Kit should be used as far as possible to avoid retesting or reassessment.

At least the worst case (the mechanically weakest case) shall be tested.

When relevant, it is possible to carry out the test with the assembled kit internal part (e.g. internal subframe, internal-board, etc.).

Values according to section 6.4.1.3 of ETAG 003 (section 2.2.6 of EAD 210005-00-0505) shall be given.

2.2.14 Internal horizontal linear static load resistance

The horizontal linear static load resistance of the kit shall be tested according to section 5.4.1.4 of ETAG 003 (section 2.2.7 of EAD 210005-00-0505).

Note: When available, performance included in the DoP regarding the Internal Partition Kit should be used as far as possible to avoid retesting or reassessment.

At least the worst case (the mechanically weakest case) shall be tested.

When relevant, it is possible to carry out the test with the assembled kit internal part (e.g. internal subframe, internal-board, etc.).

Values according to section 6.4.1.4 of ETAG 003 (section 2.2.7 of EAD 210005-00-0505) shall be given.

2.2.15 External impact resistance

The external impact resistance shall be tested according to the method given in Annex H.

At least the worst case (the mechanically weakest case) of the assembled kit shall be tested.

In the case of kits (with rendering system included) used for complete building envelopes in non-ventilated façades (Use 1 according to section 1.2.1):

- The hard body and soft body impact resistance shall be given.
- Additionally, the degree of exposure according to the use categories defined in the table H.2 in section H.3 of Annex H shall be given.

In the case of kits used for substrate of exterior-finishing (Use 2 according to section 1.2.1):

- The soft body impact resistance shall be given.
- Additionally, when the manufacturer requires it, it is possible to carry out the test considering a specific exterior-finishing. In this case, the performance of the kit stated in the ETA applies only to configurations as used in ETA process. The degree of exposure according to the use categories defined in the table H.2 in section H.3 of Annex H shall be given.

2.2.16 Internal impact resistance

The internal impact resistance of the kit shall be tested according to sections 5.4.1.1, 5.4.1.2, 5.7.1.1 and 5.7.1.2 of ETAG 003 (sections 2.2.5.1 and 2.2.5.2 of EAD 210005-00-0505).

Impacts for zones in which the risk includes, in the case of failure, the fall to a floor at a lower level shall be considered.

Note: When available, performance included in the DoP regarding the Internal Partition Kit should be used as far as possible to avoid retesting or reassessment.

At least the worst case (the mechanically weakest case) shall be tested.

When relevant, it is possible to carry out the test with the assembled kit internal part (e.g. internal subframe, internal-board, etc.).

Values according to sections 6.4.1.1, 6.4.1.2, 6.7.1.1 and 6.7.1.2 of ETAG 003 (sections 2.2.5.1 and 2.2.5.2 of EAD 210005-00-0505) shall be given.

2.2.17 Resistance to horizontal point loads

This characteristic is only relevant for kits with the rendering system, used for complete building envelope (Use 1 as given in section 1.2.1).

The resistance to horizontal points loads (e.g. one person standing on a ladder leaning against the external-board) shall be tested according to the method given in Annex I.

At least the worst case (the mechanically weakest case) of the assembled kit shall be tested.

The external wall kit shall be capable of accommodating the horizontally applied loads acting on its surface due to maintenance works without any reduction in its performance.

Description on if there is any permanent deformation (visible deformation) on any component shall be given.

2.2.18 Mechanical resistances

The following mechanical essential characteristics of the kits shall be considered:

The assessment depends on the applicable kit family and the kit to be provided by the manufacturer (complete kit, partial kit or minimum kit), see section 1.1.

Mechanical essential characteristics are:

- Bond strength. See section 2.2.18.1.
- Bending strength. See section 2.2.18.2.
- Embedding/Shear strength. See section 2.2.18.3.
- Pull-through/Pull-out resistance. See section 2.2.18.4.
- Resistance of kit subframe. See section 2.2.18.5.

2.2.18.1 Bond strength

The assessment of the kit bond strength is carried out by means of the assessment of the rendering system bond strength on the board, which is representative of this essential characteristic for the kit.

Bond strength or adhesion between the rendering system and the board (in dry and other conditions) shall be tested according to the method given in Annex J or EN 1015-12.

Tests shall be carried out for the connections and the conditions given in table J.1. of Annex J.

The test specimens shall be prepared with the board as the substrate.

When relevant, the test specimens shall be prepared at the same time that:

- the rig for the hygrothermal behaviour test (see section 2.2.24.1), and
- the samples for freeze-thaw resistance test (see section 2.2.24.1).

Mean³ and minimum values of bond strength and the rate (in %) of rupture types (cohesive rupture and/or adhesive rupture) shall be given.

2.2.18.2 Bending strength

The assessment of the kit bending strength is carried out by means of the assessment of the boards bending strength, which is representative of this essential characteristic for the kit.

The bending strength of the board shall be assessed according to the relevant hEN (see table 1.2) or EAD.

Note: When available, performance included in the DoP regarding the board should be used as far as possible to avoid retesting or reassessment.

When the hEN or EAD does not give an assessment method, the bending strength of the board shall be assessed according to section 7.3.2 of EN 12467, section 5.6 of EN 15283-1 or EN 15283-2 or section 5.7 of EN 520.

At least the worst case (the mechanically weakest case) shall be tested.

The mean³ value and the characteristic value according to Annex O shall be given.

The values shall cover the range of density and thickness of the board.

2.2.18.3 Embedding/Shear strength

The assessment of the kit embedding/shear strength is carried out by means of the assessment of the embedding/shear strength of the connection between the board, the board-fixing and the subframe profile, which is representative of this essential characteristic for the kit.

Embedding/Shear strength of the connection between the board, the board-fixing and the subframe profile shall be assessed according to the relevant hEN (see table 1.2) or EAD

Note: When available, performance included in the DoP regarding the board should be used as far as possible to avoid retesting or reassessment.

When the hEN or EAD does not give an assessment method or when there is no relevant hEN or EAD applicable, the embedding/shear strength of the connection shall be assessed according to section K.1 of Annex K.

At least the worst case (the mechanically weakest case) shall be tested.

The mean³ value and the characteristic value according to Annex O shall be given.

The values shall cover the range of density and thickness of the board, the range of board-fixing diameters and the range of materials and thickness of subframe profiles.

2.2.18.4 Pull-through/Pull-out resistance

The assessment of the kit pull-through/pull-out strength is carried out by means of the assessment of the pull-through/pull-out strength of the connection between the board, the board-fixing and the subframe profile, which is representative of this essential characteristic for the kit.

Pull-through/Pull-out strength of the connection between the board, the board-fixing and the subframe profile shall be assessed according to the relevant hEN (see table 1.2) or EAD

Note: When available, performance included in the DoP regarding the board should be used as far as possible to avoid retesting or reassessment.

When the hEN or EAD does not give an assessment method or when there is no relevant hEN or EAD applicable, the pull-through/pull-out strength of the connection shall be assessed according to section K.2 of Annex K.

At least the worst case (the mechanically weakest case) shall be tested.

The mean³ value and the characteristic value according to Annex O shall be given.

The values shall cover the range of density and thickness of the board, the range of board-fixing diameters and the range of materials and thickness of subframe profiles.

2.2.18.5 Resistance of kit subframe profiles

This characteristic is only relevant when the manufacturer provides a kit which includes the subframe components (see section 1.1).

The assessment of the kit subframe resistance is carried out by means of the assessment of the resistance of the kit subframe profiles, which is representative of this essential characteristic for the kit.

The following characteristics shall be described:

- Form and dimensions of the profile section according to relevant standards (e.g. EN 755-9 for aluminium).
- Effective moment of area (inertia of the profile section) according to the relevant standards (e.g. EN 1999-1-1 for aluminium).
- Minimum mechanical properties of the profile material. E.g. elastic limit and modulus of elasticity in the case of metal profiles according to the relevant standards (e.g. EN 755-2 for aluminium).
- Maximum deflection admitted by the manufacturer (e.g. L/200).

2.2.19 Airborne sound insulation

The assessment of the airborne sound insulation of the kit is carried out by means of the airborne sound insulation test (see section 2.2.19.1) and the airflow resistivity of the thermal insulation (see section 2.2.19.2), which are representative of this essential characteristic for the kit.

2.2.19.1 Airborne sound insulation

The airborne sound insulation of the kit shall be tested according to EN ISO 10140-2.

At least the worst or the most representative assembled kit shall be tested. For the determination of the external wall kit airborne sound insulation, parameters such as the dynamic stiffness of the insulation product (see section 2.2.19.2), total mass per unit area (in kg/m²) and the density of board-fixings must be known.

The ratings of airborne sound insulation shall be undertaken according to EN ISO 717-1.

The weighted sound reduction index R_w and the spectrum adaptation terms C and C_{tr} , shall be given.

2.2.19.2 Airflow resistivity of the thermal insulation

This characteristic is only relevant when the manufacturer provides a kit which includes the thermal insulation product (see section 1.1).

Airflow resistivity of the kit is associated to the airflow resistivity of the thermal insulation product and it shall be assessed according to the relevant hEN or EAD (see table 1.2).

Note: When available, performance included in the DoP regarding the thermal insulation product should be used as far as possible to avoid retesting or reassessment.

When there is no relevant hEN or EAD applicable, the airflow resistivity of the thermal insulation product shall be tested according to EN 29053.

Airflow resistivity value for the thermal insulation product shall be given.

2.2.20 Sound absorption

This characteristic is only relevant for the internal part of the external wall kit (internal subframe, internal-board).

The sound absorption of the kit shall be assessed according to the relevant hEN (see table 1.2) or EAD of the internal-boards.

Note: When available, performance included in the DoP regarding the board should be used as far as possible to avoid retesting or reassessment.

When the hEN or EAD does not give an assessment method, the sound absorption shall be tested according to EN ISO 354 and assessed according to EN ISO 11654.

When relevant, it is possible to carry out the test with the assembled kit internal part (e.g. internal subframe, internal-board, etc.).

The sound absorption coefficient (α_s), the practical sound absorption coefficient (α_p) and the weighted sound absorption coefficient (α_w) shall be given.

2.2.21 Thermal resistance

Thermal resistance (R-value) of the assembled kit shall be calculated according to EN ISO 6946, using the thermal resistance of the kit components obtained from the relevant European product standards (see table 1.2), or tested according to EN 12667, EN 12939 or EN 12664. Alternatively, the thermal resistance may be tested according to EN ISO 8990. Tabulated values of the kit components materials according to EN ISO 10456 may also be defined by the manufacturer.

In the case of the rendering system, test for the whole rendering system is recommended.

The assembled kit thermal bridges shall be calculated according to EN ISO 10211.

At least, the worst or the most representative assembled kit shall be assessed.

Thermal resistance value for the assembled kit shall be given.

2.2.22 Thermal inertia

The thermal inertia of the kit shall be carried out by calculation according to EN ISO 13786.

For the calculation the following parameters must be known:

- Assembled kit total mass per unit area (in kg/m²). At least the worst or the most representative assembled kit shall be calculated.
- Density of each kit component (in kg/m³).
- Heat capacity (in J/kg·K) of each kit component (see section 2.2.23).
- Thermal resistance (in m²·K/W) of kit components or assembled kit (see section 2.2.21).
- Detailed design of the assembled kit (drawings and geometry).

Areal heat capacity and time shift values according to EN ISO 13786 shall be given.

2.2.23 Heat capacity

The assessment of the kit heat capacity is carried out by means of the assessment of the heat capacity of the relevant kit components (rendering system, board, thermal insulation product and breather membrane) representative of this essential characteristic for external wall kits.

Heat capacity of the kit components shall be assessed according to the relevant hEN (see table 1.2) or EAD.

Note: When available, performance included in the DoP regarding the relevant kit components should be used as far as possible to avoid retesting or reassessment.

When the hEN or EAD does not give an assessment method, the heat capacity of the relevant kit components shall be tested according to EN ISO 22007-1 or EN ISO 11357-4. Tabulated values according to EN ISO 10456 may also be defined by the manufacturer.

The values shall be given according to the relevant technical specification.

2.2.24 Durability

The assessment of the durability of the kit is carried out by means of the assessment of the following characteristics which are representative of this essential characteristic:

- Accelerated ageing behaviour. See sections 2.2.24.1.
- Cracking strength due to board deformation. See section 2.2.24.2.
- Dimensional stability. See section 2.2.24.3.
- Moisture content. See section 2.2.24.4.
- Corrosion. See sections 2.2.24.5.
- UV radiation resistance. See section 2.2.24.6.

2.2.24.1 Accelerated ageing behaviour

In the case of kits (with rendering system included) used for complete building envelopes in non-ventilated façades (Use 1 according to section 1.2.1):

Accelerated ageing behaviour of the kit shall be assessed by means of bond strength test (see section 2.2.18.1) and water absorption by capillarity test (see section 2.2.6.1) of specimens taken from the assembled kit submitted to:

- The hygrothermal cycles given in section L.1 of Annex L.
- The freeze-thaw cycles given in section L.2 of Annex L. The freeze-thaw resistance test shall only be carried out when the water absorption by capillarity of the whole rendering system (see section 2.2.6.1) is greater or equal than 0,5 kg/m² after 24 hours.
- Alternatively, when required by the manufacturer, the combined test with hygrothermal and freeze-thaw cycles given in section L.3 of Annex L may be carried out.

At least the worst case (e.g. minimum bond strength, maximum water absorption by capillarity, minimum thickness of kit components, without the breather membrane, etc.) or the most representative case of the kit shall be tested. See also section L.1.2 of Annex L.

It is possible to carry out the test only with the external layer of the assembled kit (rendering system and board).

If any of the following defects occur during or at the end of the accelerated ageing cycles programme, it shall be recorded.

- deterioration such as cracking or delamination of the rendering system or the boards that allows water penetration to the internal layers;
- detachment of the rendering system or the board;
- irreversible deformation.

The following values shall be given:

- Minimum value of bond strength tests (see section 2.2.18.1) after ageing cycles (in MPa).
- Ratio (in %) between the bond strength mean value after ageing cycles test and the mean value in the bond strength tests without ageing cycles.
- Maximum value of the water absorption by capillarity (see section 2.2.6.1) after ageing cycles (in kg/m²).
- Ratio (in %) between the water absorption by capillarity mean value after ageing cycles test and the mean value in the water absorption by capillarity tests without ageing cycles.

In the case of kits without rendering system used as substrate of exterior-finishing in non-ventilated and ventilated façades (Use 2 according to section 1.2.1)

The exterior-finishing contributes to the accelerated ageing behaviour of the kit; therefore, it may be described either as:

- “depends on the exterior-finishing” or,
- when the manufacturer requires it, it is possible to carry out the assessment, as indicated previously for kits for Use 1 according to section 1.2.1), considering a specific exterior-finishing. In this case, the performance of the kit stated in the ETA applies only to configurations as used in the ETA process and depending on the exterior-finishing (e.g. exterior-finishing such as cladding kits), only the description on if any of the defects indicated previously occur during or at the end of the test programme.

2.2.24.2 Cracking strength due to board deformation

This characteristic is only relevant when the kit includes the rendering system and it is used for complete building envelopes in non-ventilated façades.

Cracking strength due to board deformation shall be assessed by means of water absorption by capillarity tests (see section 2.2.6.1) of specimens taken from the assembled kit submitted to movement cycles given in section L.4 of Annex L.

At least the worst case (e.g. minimum bond strength, maximum water absorption by capillarity, minimum thickness of kit components, etc.) or the most representative case of the kit shall be tested.

If any of the following defects occur during or at the end of the cycles programme, it shall be recorded.

- deterioration such as cracking or delamination of the rendering system or the boards;
- detachment of the rendering system or the board;
- irreversible deformation.

The following values shall be given:

- Maximum value of the water absorption by capillarity (see section 2.2.6.1) after ageing cycles (in kg/m²).
- Ratio (in %) between the water absorption by capillarity mean value after ageing cycles test and the mean value in the water absorption by capillarity tests without ageing cycles.

2.2.24.3 Dimensional stability

Dimensional stability of the kit shall be assessed by means of the dimensional stability of the kit components that are known to be or suspected of being sensitive to changes in environmental relative humidity and/or temperature.

Dimensional stability by humidity

The dimensional stability of the kit components associated with changes in relative humidity shall be assessed according to the relevant hEN (see table 1.2) or EAD.

Note: When available, performance included in the DoP regarding the relevant kit components should be used as far as possible to avoid retesting or reassessment.

When the hEN or EAD does not give an assessment method or when there is no relevant hEN or EAD applicable, the dimensional variation by humidity of the kit components shall be assessed according to EN 318 or EN 1170-7.

The maximum value for each sensitive kit component shall be given.

The values shall cover the range of density of the kit components.

Linear thermal expansion

The dimensional stability of the kit components associated with changes in temperature shall be assessed according to the relevant hEN (see table 1.2) or EAD.

Note: When available, performance included in the DoP regarding the relevant kit components should be used as far as possible to avoid retesting or reassessment.

When the hEN or EAD does not give an assessment method or when there is no relevant hEN or EAD applicable, the linear thermal expansion coefficient of the kit components shall be assessed according to section 3.2.6 of EN 1993-1-1, section 3.2.5 of EN 1999-1-1 or EN 14617-11.

The maximum value for each sensitive kit component shall be given.

The values shall cover the range of density of the kit components.

2.2.24.4 Moisture content

This characteristic is only relevant for kits with components that are known to be or suspected of being sensitive to moisture.

The moisture content of the kit components shall be assessed according to the relevant hEN (see table 1.2) or EAD.

Note: When available, performance included in the DoP regarding the relevant kit components should be used as far as possible to avoid retesting or reassessment.

When the hEN or EAD does not give an assessment method or when there is no relevant hEN or EAD applicable, the shall be assessed according to EN 322.

The moisture content maximum value for each sensitive kit component shall be given.

The values shall cover the range of density of the boards.

2.2.24.5 Corrosion

The assessment of the kit corrosion is carried out by means of the assessment of the metal kit components corrosion representative of this essential characteristic for external wall kits.

The corrosion protection of the metal components of the kits shall be described according to the appropriate EN standard (e.g. EN 10346 for continuously hot-dip coated steels).

The choice of steel, aluminium and stainless-steel grade shall be described according to the appropriate EN standards (e.g. EN 10346 for continuously hot-dip coated steel, EN 755-1 and EN 1999-1-1 for aluminium alloys, EN 10088-4 for stainless steels).

The steel or aluminium grade and the respective corrosion protection shall be described in function of the field of application and the corrosivity of atmospheres defined in EN ISO 9223 (e.g. marine atmosphere, industrial atmosphere, etc.). In particularly aggressive atmospheres with extreme chemical pollution (e.g. desulphurization plants, chloride atmosphere), special measures of corrosion protection shall be foreseen.

If necessary, the performance deterioration caused by corrosion should also be described.

2.2.24.6 UV radiation resistance

This characteristic is only relevant for kits with components that are known to be or suspected of being sensitive to UV radiation.

Kit components behaviour after UV radiation ageing shall be assessed according to the relevant hEN (see table 1.2) or EAD.

Note: When available, performance included in the DoP regarding the relevant kit components should be used as far as possible to avoid retesting or reassessment.

When the hEN or EAD does not give an assessment method or when there is no relevant hEN or EAD applicable, the following standards shall be taken into account: EN ISO 877-1, EN ISO 877-3, EN ISO 4892-1, EN ISO 4892-2, EN ISO 4892-3, EN 927-2, EN 13245-2 or EN 10169.

Test results shall be given according to the relevant hEN, EAD or standard listed above.

3 ASSESSMENT AND VERIFICATION OF CONSTANCY OF PERFORMANCE

3.1 System(s) of assessment and verification of constancy of performance to be applied

For the products covered by this EAD the applicable European legal act is Decision 2003/640/EC.

The applicable AVCP system is 2+ for any use except for uses subject to regulations on reaction to fire.

For uses subject to regulations on reaction to fire⁵ the applicable AVCP systems regarding reaction to fire are 1, or 3, or 4 depending on the conditions defined in the said Decision.

The performance of any kit component which is obtained from a component manufacturer and is CE marked on the basis of a hEN or an EAD will, (for the purposes of verification of constancy of performance) be considered to be the performance declared by the component manufacturer in his DoP. The component does not need to be re-assessed regarding this performance aspect.

3.2 Tasks of the manufacturer

The cornerstones of the actions to be undertaken by the manufacturer of the product in the procedure of assessment and verification of constancy of performance are laid down in table 3.1a.

The actions to be undertaken by the manufacturer of the product for the different components of the kit are laid down in table 3.1b to 3.1e when the components are produced by the manufacturer itself and table 3.1f when the components are not produced by the manufacturer itself but by its supplier under the specifications of the manufacturer.

Table 3.1a: Control plan for the manufacturer; cornerstones.

No	Subject/type of control	Test or control method	Criteria, if any	Minimum number of specimens	Minimum frequency of control
Factory production control (FPC)					
1	Components <u>produced by the manufacturer itself</u> :				
	▪ Boards	See table 3.1b	See table 3.1b	See table 3.1b	See table 3.1b
	▪ Base-coat or finishing coat	See table 3.1c	See table 3.1c	See table 3.1c	See table 3.1c
	▪ Glass fibre reinforcement mesh	See table 3.1d	See table 3.1d	See table 3.1d	See table 3.1d
	▪ Board-fixings and subframe components	See table 3.1e	See table 3.1e	See table 3.1e	See table 3.1e
	▪ Breather membranes	Acc. to the relevant hEN or EAD	Acc. to the Control Plan	Acc. to Control Plan	Acc. to the relevant hEN or EAD
	▪ Thermal insulation product	Acc. to the relevant hEN or EAD	Acc. to the Control Plan	Acc. to Control Plan	Acc. to the relevant hEN or EAD
	▪ Ancillary components	Acc. to the Control Plan	Acc. to the Control Plan	Acc. to the Control Plan	Acc. to the Control Plan
2	Components <u>not produced by the manufacturer itself</u> (*)	See table 3.1f	See table 3.1f	See table 3.1f	See table 3.1f
(*) Components produced by the supplier under the specifications of the manufacturer.					

⁵ Including propensity to undergo continuous smouldering, where relevant.

Table 3.1b: Control plan when the board is produced by the manufacturer itself; cornerstones.

No	Subject/type of control	Test or control method	Criteria, if any	Minimum number of specimens	Minimum frequency of control
Factory production control (FPC)					
Incoming materials					
1	Receipt materials	Delivery ticket or label on the package	Conformity with the order	---	Each delivery
		Supplier certificates or supplier tests			
Finished component					
1	Geometry (form and dimensions)	When apply, acc. to the relevant hEN or EAD Otherwise measuring, visual check or section A.1 of Annex A	Acc. to the Control Plan	According to tests or control methods	Acc. to the Control Plan (*)
2	Density or mass per unit area or per unit	When apply, acc. to the relevant hEN or EAD Otherwise section A.2 of Annex A			
3	Mechanical characteristics	Test or control based on relevant sections 2.2.18.2 to 2.2.18.4			At least once each 5 years
		Test acc. to sections 2.2.18.2 to 2.2.18.4			
(*) The frequency is determined case by case depending on the type of production process, the variation in the volume produced and the production process control.					

Table 3.1c: Control plan when the base-coat or finishing coat is produced by the manufacturer itself; cornerstones.

No	Subject/type of control	Test or control method	Criteria, if any	Minimum number of specimens	Minimum frequency of control
Factory production control (FPC)					
Base-coat and finishing coat components					
Incoming materials					
1	Receipt materials	Delivery ticket and/or label on the package	Conformity with the order	---	Each delivery
		Supplier certificates or supplier tests			
2	Particle size grading	Acc. to the Control Plan	Acc. to the Control Plan	Acc. to the Control Plan	Acc. to the Control Plan
3	Bulk density				
Production process					
4	Mixing process	According to the Control Plan	According to the Control Plan	According to the Control Plan	According to the Control Plan
5	Packing				
Finished component					
6	Density (1)	A.3 of Annex A			

Table 3.1c: Control plan when the base-coat or finishing coat is produced by the manufacturer itself; cornerstones.

No	Subject/type of control	Test or control method	Criteria, if any	Minimum number of specimens	Minimum frequency of control
7	Particle size grading (2) (3)	A.4 of Annex A	Acc. to the Control Plan	According to test or control methods	Acc. to the Control Plan (*)
8	Dry extract at 105 °C (2)	A.5 of Annex A			
9	Ash content at 450 °C (3)	A.6.1 of Annex A			
10	Modulus of elasticity, tensile strength and elongation (1) (4)	A.7 of Annex A	Acc. to the Control Plan	According to test or control methods	Acc. to the Control Plan (*)
11	Shrinkage (1) (4)	A.8 of Annex A			
12	Crack bridging resistance (5)	Acc. to the Control Plan, method based on EN ISO 4628-4			
13	Bond strength (1) (6)	Section 2.2.18.1			
(*) The frequency is determined case by case depending on the variation in the volume produced and the production process control. (1) on hardened mortar (2) only for mortars delivered in paste (3) on powder mortar (4) only applicable to mortars (5) only for paints (6) applicable for the whole rendering system					

Table 3.1d: Control plan when the glass fibre reinforcement mesh is produced by the manufacturer itself; cornerstones.

No	Subject/type of control	Test or control method	Criteria, if any	Minimum number of specimens	Minimum frequency of control	
Factory production control (FPC)						
Glass fibre reinforcement mesh						
Incoming materials						
1	Receipt materials	Delivery ticket and/or label on the package Supplier certificates or supplier tests	Conformity with the order	---	Each delivery	
Finished component						
1	Mass per unit area	A.9 of Annex A	Acc. to the Control Plan	According to test or control methods	Acc. to the Control Plan (*)	
2	Ash content at 625 °C	A.6.2 of Annex A				
3	Mesh size and number of filaments	A.10 of Annex A				
4	Tensile strength and elongation	without ageing				A.11 of Annex A
		with ageing				
5	Alkali resistance	Test or control acc. to the Control Plan				
(*) The frequency is determined case by case depending on the variation in the volume produced and the production process control.						

Table 3.1e: Control plan when the board-fixings and/or subframe components are produced by the manufacturer itself; cornerstones.

No	Subject/type of control	Test or control method	Criteria, if any	Minimum number of specimens	Minimum frequency of control
Factory production control (FPC)					
Incoming materials					
1	Receipt materials	Delivery ticket or label on the package	Conformity with the order	---	Each delivery
		Supplier certificates or supplier tests			
Finished component					
1	Geometry (form and dimensions)	Measuring and visual check	Acc. to the Control Plan	According to tests or control methods	Acc. to the Control Plan (*)
2	Mechanical characteristics	Test or control based on relevant sections 2.2.18.3 to 2.2.18.5			
		Test acc. to sections 2.2.18.3 to 2.2.18.5			At least once each 5 years
(*) The frequency is determined case by case depending on the type of production process, the variation in the volume produced and the production process control.					

Table 3.1f: Control plan when the components are not produced by the manufacturer; cornerstones.

No	Subject/type of control	Test or control method	Criteria, if any	Minimum number of specimens	Minimum frequency of control
Factory production control (FPC)					
1	Components belonging to Case 1 (*)	(1)	Conformity with the order	Testing is not required	Each delivery
		(2)	Acc. to the Control Plan	Testing is not required	Each delivery
2	Components belonging to Case 2 (*):	(1)	Conformity with the order	Testing is not required	Each delivery
		▪ Characteristics declared in DoP for the specific use within the kit.	Acc. to the Control Plan	Testing is not required	Each delivery
		▪ Characteristics not declared in DoP for the specific use within the kit.	(3)	Acc. to the Control Plan	Acc. to Control Plan
3	Components belonging to Case 3 (*):	(1)	Conformity with the order	Testing is not required	Each delivery
		(3)	Acc. to the Control Plan	Acc. to Control Plan	Acc. to Control Plan
(1) Checking of delivery ticket and/or label on the package. (2) Checking of technical data sheet and DoP or, when relevant: supplier certificates or supplier tests or test or control acc. to tables 3.1a to 3.1e above. (3) Supplier certificates or supplier tests or Test or control acc. to tables 3.1a to 3.1e above.					

Table 3.1f: Control plan when the components are not produced by the manufacturer; cornerstones.

No	Subject/type of control	Test or control method	Criteria, if any	Minimum number of specimens	Minimum frequency of control
(*) Case 1: Component covered by a hEN or its own ETA for all characteristics needed for the specific use within the kit. Case 2: If the component is a product covered by a hEN or its own ETA which, however, does not include all characteristics needed for the specific use within the kit or the characteristic is presented as NPD option for the component manufacturer. Case 3: The component is a product not (yet) covered by a hEN or its own ETA.					

3.3 Tasks of the notified body

The cornerstones of the actions to be undertaken by the notified body in the procedure of assessment and verification of constancy of performance for external wall kit are laid down in table 3.2.

Table 3.2: Tasks of the notified body under AVCP system 2+.

No	Subject/type of control	Test or control method	Criteria, if any	Minimum number of samples	Minimum frequency of control
Initial inspection of the manufacturing plant and of factory production control					
1	Initial inspection of the manufacturing plant and of factory production control carried out by the manufacturer considering the constancy of performances of kit components defined in the Control Plan (except reaction to fire).	As defined in the control plan	As defined in the control plan	As defined in the control plan	When starting the production
Continuous surveillance, assessment and evaluation of factory production control					
2	Continuous surveillance, assessment and evaluation of the factory production control carried out by the manufacturer considering the constancy of performances of kit components defined in the Control Plan.	As defined in the control plan	As defined in the control plan	As defined in the control plan	Once per year

Regarding reaction to fire, the intervention of the notified body under AVCP system 1 is only necessary for reaction to fire for products/materials for which a clearly identifiable stage in the production process results in an improvement of the reaction to fire classification (e.g. an addition of fire retardants or a limiting of organic material).

In this case the cornerstones of the tasks to be undertaken by the notified body under AVCP system 1 are laid down in table 3.3.

Table 3.3: Tasks of the notified body under AVCP system 1.

No	Subject/type of control	Test or control method	Criteria, if any	Minimum number of samples	Minimum frequency of control
Initial inspection of the manufacturing plant and of factory production control					
1	Initial inspection of the manufacturing plant and of factory production control carried out by the manufacturer considering the constancy of performances of reaction to fire and taking into account the limit of organic material and/or the addition of fire retardants.	As defined in the control plan	As defined in the control plan	As defined in the control plan	When starting the production
Continuous surveillance, assessment and evaluation of factory production control					
2	Continuous surveillance, assessment and evaluation of the factory production control carried out by the manufacturer considering the constancy of performances of reaction to fire and taking into account the limit of organic material and/or the addition of fire retardants.	As defined in the control plan	As defined in the control plan	As defined in the control plan	Once per year

3.4 Special methods of control and testing used for the verification of constancy of performance

Annex A establishes special methods of components used for the verification of constancy of performance, and when relevant, for the characterization of the kit component.

4 REFERENCE DOCUMENTS

As far as no edition date is given in the list of standards thereafter, the standard in its current version at the time of issuing the European Technical Assessment, is of relevance.

EAD 040016	Glass fibre mesh for reinforcement of cement-based renderings.
EAD 210024	Cement-bonded boards.
EAD 330232	Mechanical fasteners for use in concrete.
EAD 330499	Bonded fasteners for use in concrete.
EAD 330747	Fasteners for use in concrete for redundant non-structural systems (ETAG 001-6).
ETAG 001-6	Metal Anchors for Use in Concrete. Part 6: Anchors for multiple use for non-structural applications.
EAD 210005	Internal Partition Kit (ETAG 003 conversion).
ETAG 003	Internal Partition Kits for use as non-loadbearing walls
EAD 330284	Plastic anchors for redundant non-structural systems in concrete and masonry (ETAG 020 conversion).
ETAG 020	Plastic Anchors. Part 1: General. Part 2: for use in normal weight concrete. Part 3: for use in solid masonry materials. Part 4: for use in hollow or perforated masonry. Part 5: for use in autoclaved aerated concrete.
EOTA TR 001	Determination of impact resistance of panels and panels assemblies.
EN 10088-1	Stainless steels - Part 1: List of stainless steels.
EN 10088-2	Stainless steels - Part 2: Technical delivery conditions for sheet/plate and strip of corrosion resisting steels for general purposes.
EN 10088-4	Stainless steels - Part 4: Technical delivery conditions for sheet/plate and strip of corrosion resisting steels for construction purposes.
EN 1015-10	Methods of test for mortar for masonry-Part 10: Determination of dry bulk density of hardened mortar.
EN 1015-12	Methods of test for mortar for masonry - Part 12: Determination of adhesive strength of hardened rendering and plastering mortars on substrates.
EN 1015-18	Methods of test for mortar for masonry - Part 18: Determination of water absorption coefficient due to capillary action of hardened mortar.
EN 1015-19	Methods of test for mortar for masonry – Part 19: Determination of water vapour permeability of hardened rendering and plastering mortars.
EN 1015-21	Methods of test for mortar for masonry - Part 21: Determination of the compatibility of one-coat rendering mortars with substrates.
EN 10169	Continuously organic coated (coil coated) steel flat products - Technical delivery condition.
EN 10346	Continuously hot-dip coated steel flat products for cold forming - Technical delivery conditions.
EN 1062-1	Paints and varnishes - Coating materials and coating systems for exterior masonry and concrete - Part 1: Classification
EN 1170-7	Precast concrete products. Test method for glass-fibre reinforced cement. Part 7: Measurement of extremes of dimensional variations due to moisture content.
EN 12020-1	Aluminium and aluminium alloys - Extruded precision profiles in alloys EN AW-6060 and EN AW-6063 - Part 1: Technical conditions for inspection and delivery.
EN 12020-2	Aluminium and aluminium alloys - Extruded precision profiles in alloys EN AW-6060 and EN AW-6063 - Part 2: Tolerances on dimensions and form.

EN 12086	Thermal insulating products for building applications - Determination of water vapour transmission properties.
EN 12087	Thermal insulating products for building applications - Determination of long term water absorption by immersion.
EN 12088	Thermal insulating products for building applications - Determination of long term water absorption by diffusion.
EN 12152	Curtain walling - Air permeability - Performance requirements and classification
EN 12153	Curtain walling - Air permeability - Test method.
EN 12154	Curtain walling - Watertightness - Performance requirements and classification
EN 12155	Curtain walling - Watertightness - Laboratory test under static pressure.
EN 12179	Curtain walling - Resistance to wind load - Test method.
EN 12467	Fibre-cement flat sheets - Product specification and test methods.
EN 12617-4	Products and systems for the protection and repair of concrete structures - Test methods - Part 4: Determination of shrinkage and expansion.
EN 12664	Thermal performance of building materials and products. Determination of thermal resistance by means of guarded hot plate and heat flow meter methods. Dry and moist products of medium and low thermal resistance.
EN 12667	Thermal performance of building materials and products. Determination of thermal resistance by means of guarded hot plate and heat flow meter methods. Products of high and medium thermal resistance.
EN 12808-4	Grouts for tiles - Part 4: Determination of shrinkage
EN 12865	Hygrothermal performance of building components and building elements - Determination of the resistance of external wall systems to driving rain under pulsating air pressure.
EN 12939	Thermal performance of building materials and products - Determination of thermal resistance by means of guarded hot plate and heat flow meter methods - Thick products of high and medium thermal resistance.
EN 13162	Thermal insulation products for buildings - Factory made mineral wool (MW) products - Specification
EN 13163	Thermal insulation products for buildings - Factory made expanded polystyrene (EPS) products – Specification.
EN 13164	Thermal insulation products for buildings - Factory made extruded polystyrene foam (XPS) products – Specification.
EN 13165	Thermal insulation products for buildings - Factory made rigid polyurethane foam (PU) products – Specification.
EN 13166	Thermal insulation products for buildings - Factory made phenolic foam (PF) products – Specification.
EN 13238	Reaction to fire tests for building products - Conditioning procedures and general rules for selection of substrates.
EN 13245-2	Plastics - Unplasticized poly (vinyl chloride) (PVC-U) profiles for building applications - Part 2: PVC-U profiles and PVC-UE profiles for internal and external wall and ceiling finishes.
EN 13496	Thermal insulation products for building applications - Determination of the mechanical properties of glass fibre meshes as reinforcement for External Thermal Insulation Composite Systems with renders (ETICS).
EN 13501-1	Fire classification of construction products and building elements - Part 1: Classification using data from reaction to fire tests.
EN 13501-2	Fire classification of construction products and building elements - Part 2: Classification using data from fire resistance tests, excluding ventilation services

EN 1364-1	Fire resistance tests for non-loadbearing elements. Walls.
EN 13823	Reaction to fire tests for building products - Building products excluding floorings exposed to the thermal attack by a single burning item.
EN 13830	Curtain walling - Product standard
EN 13859-2	Flexible sheets for waterproofing - Definitions and characteristics of underlays - Part 2: Underlays for walls.
EN 13963	Jointing materials for gypsum boards - Definitions, requirements and test methods
EN 13984	Flexible sheets for waterproofing - Plastic and rubber vapour control layers - Definitions and characteristics
EN 14081-1	Timber structures - Strength graded structural timber with rectangular cross section - Part 1: General requirements.
EN 14190	Gypsum plasterboard products from reprocessing - Definitions, requirements and test methods
EN 14195	Metal framing components for gypsum board systems - Definitions, requirements and test methods
EN 14399-1	High strength structural bolting assemblies for preloading - Part 1: General requirements
EN 14566	Mechanical fasteners for gypsum plasterboard systems - Definitions, requirements and test methods
EN 14592	Timber structures - Dowel-type fasteners – Requirements.
EN 14617-11	Agglomerated stone - Test methods - Part 11: Determination of linear thermal expansion coefficient.
EN 15048-1	Non-preloaded structural bolting assemblies - Part 1: General requirements
EN 15283-1	Gypsum boards with fibrous reinforcement - Definitions, requirements and test methods - Part 1: Gypsum boards with mat reinforcement
EN 15283-2	Gypsum boards with fibrous reinforcement - Definitions, requirements and test methods - Part 2: Gypsum fibre boards
EN 15824	Specifications for external renders and internal plasters based on organic binders
EN 1602	Thermal insulating products for building applications - Determination of the apparent density.
EN 1609	Thermal insulating products for building applications - Determination of short term water absorption by partial immersion.
EN 16516	Construction products. Assessment of release of dangerous substances - Determination of emissions into indoor air.
EN 1990	Eurocode - Basis of structural design.
EN 1993	Eurocode 3: Design of steel structures.
EN 1993-1-1	Eurocode 3: Design of steel structures - Part 1-1: General rules and rules for buildings.
EN 1999	Eurocode 9: Design of aluminium structures.
EN 1999-1-1	Eurocode 9: Design of aluminium structures - Part 1-1: General structural rules.
EN 29053	Acoustics. Materials for acoustical applications. Determination of airflow resistance. (ISO 9053:1991).
EN 318	Wood based panels - Determination of dimensional changes associated with changes in relative humidity.
EN 322	Wood-based panels. Determination of moisture content.

EN 480-8	Admixtures for concrete, mortar and grout. Test methods. Part 8: Determination of the conventional dry material content.
EN 520	Gypsum plasterboards - Definitions, requirements and test methods.
EN 755-1	Aluminium and aluminium alloys- Extruded rod/bar, tube and profiles - Part 1: Technical conditions for inspection and delivery.
EN 755-2	Aluminium and aluminium alloys - Extruded rod/bar, tube and profiles - Part 2: Mechanical properties.
EN 755-9	Aluminium and aluminium alloys - Extruded rod/bar, tube and profiles - Part 9: Profiles, tolerances on dimensions and form.
EN 822	Thermal insulating products for building applications - Determination of length and width.
EN 823	Thermal insulating products for building applications - Determination of thickness.
EN 927-2	Paints and varnishes - Coating materials and coating systems for exterior wood - Part 2: Performance specification.
EN 998-1	Specification for mortar for masonry - Part 1: Rendering and plastering mortar
EN ISO 10140-1	Acoustics - Laboratory measurement of sound insulation of building elements - Part 1: Application rules for specific products.
EN ISO 10211	Thermal bridges in building construction - Heat flows and surface temperatures - Detailed calculations.
EN ISO 10456	Building materials and products - Hygrothermal properties -Tabulated design values and procedures for determining declared and design thermal values.
EN ISO 10666	Drilling screws with tapping screw thread - Mechanical and functional properties.
EN ISO 11348-1	Water quality. Determination of the inhibitory effect of water samples on the light emission of <i>Vibrio fischeri</i> (Luminescent bacteria test). Part 1: Method using freshly prepared bacteria.
EN ISO 11348-2	Water quality. Determination of the inhibitory effect of water samples on the light emission of <i>Vibrio fischeri</i> (Luminescent bacteria test). Part 2: Method using liquid-dried bacteria.
EN ISO 11348-3	Water quality. Determination of the inhibitory effect of water samples on the light emission of <i>Vibrio fischeri</i> (Luminescent bacteria test). Part 3: Method using freeze-dried bacteria.
EN ISO 11357-4	Plastics - Differential scanning calorimetry (DSC) - Part 4: Determination of specific heat capacity
EN ISO 11654	Acoustics -- Sound absorbers for use in buildings -- Rating of sound absorption
EN ISO 11925-2	Reaction to fire tests - Ignitability of products subjected to direct impingement of flame - Part 2: Single-flame source test.
EN ISO 12572	Hygrothermal performance of building materials and products - Determination of water vapour transmission properties.
EN ISO 13786	Thermal performance of building components - Dynamic thermal characteristics - Calculation methods
EN ISO 13788	Hygrothermal performance of building components and building elements -- Internal surface temperature to avoid critical surface humidity and interstitial condensation -- Calculation methods
EN ISO 14588	Blind rivets - Terminology and definitions.
EN ISO 15148	Hygrothermal performance of building materials and products - Determination of water absorption coefficient by partial immersion.
EN ISO 15973	Closed end blind rivets with break pull mandrel and protruding head.
EN ISO 15974	Closed end blind rivets with break pull mandrel and countersunk head.

EN ISO 15975	Closed end blind rivets with break pull mandrel and protruding head.
EN ISO 15976	Closed end blind rivets with break pull mandrel and protruding head.
EN ISO 15977	Open end blind rivets with break pull mandrel and protruding head.
EN ISO 15978	Open end blind rivets with break pull mandrel and countersunk head.
EN ISO 15979	Open end blind rivets with break pull mandrel and protruding head.
EN ISO 15980	Open end blind rivets with break pull mandrel and countersunk head.
EN ISO 15981	Open end blind rivets with break pull mandrel and protruding head.
EN ISO 15982	Open end blind rivets with break pull mandrel and countersunk head.
EN ISO 15983	Open end blind rivets with break pull mandrel and protruding head.
EN ISO 15984	Open end blind rivets with break pull mandrel and countersunk head.
EN ISO 16582	Open end blind rivets with break pull mandrel and protruding head.
EN ISO 16583	Open end blind rivets with break pull mandrel and countersunk head.
EN ISO 16584	Open end blind rivets with break pull mandrel and protruding head.
EN ISO 16585	Closed end blind rivets with pull mandrel and protruding head.
EN ISO 1716	Reaction to fire tests for products - Determination of the gross heat of combustion (calorific value).
EN ISO 22007-1	Plastics - Determination of thermal conductivity and thermal diffusivity - Part 1: General principles
EN ISO 22007-2	Plastics - Determination of thermal conductivity and thermal diffusivity - Part 2: Transient plane heat source (hot disc) method
EN ISO 3506-1	Mechanical properties of corrosion-resistant stainless steel fasteners - Part 1: Bolts, screws and studs.
EN ISO 3506-2	Mechanical properties of corrosion-resistant stainless steel fasteners - Part 2: Nuts.
EN ISO 3506-3	Mechanical properties of corrosion-resistant stainless steel fasteners - Part 3: Set screws and similar fasteners not under tensile stress.
EN ISO 3506-4	Mechanical properties of corrosion-resistant stainless steel fasteners - Part 4: Tapping screws.
EN ISO 354	Acoustics - Measurement of sound absorption in a reverberation room
EN ISO 4628-4	Paints and varnishes - Evaluation of degradation of coatings - Designation of quantity and size of defects, and of intensity of uniform changes in appearance - Part 4: Assessment of degree of cracking (ISO 4628-4:2016)
EN ISO 4892-1	Plastics - Methods of exposure to laboratory light sources - Part 1: General guidance.
EN ISO 4892-2	Plastics - Methods of exposure to laboratory light sources - Part 2: Xenon-arc lamps (ISO 4892-2:2013).
EN ISO 4892-3	Plastics - Methods of exposure to laboratory light sources - Part 3: Fluorescent UV lamps.
EN ISO 6341	Water quality. Determination of the inhibition of the mobility of Daphnia magna Straus (Cladocera, Crustacea). Acute toxicity test.
EN ISO 6946	Building components and building elements - Thermal resistance and thermal transmittance - Calculation method.
EN ISO 717-1	Acoustics - Rating of sound insulation in buildings and of building elements - Part 1: Airborne sound insulation.
EN ISO 7783	Paints and varnishes - Determination of water-vapour transmission properties - Cup method
EN ISO 877-1	Plastics - Methods of exposure to solar radiation - Part 1: General guidance.

EN ISO 877-3	Plásticos. Métodos de exposición a la radiación solar. Parte 3: Exposición intensificada por radiación solar concentrada.
EN ISO 8990	Thermal insulation. Determination of steady-state thermal transmission properties. Calibrated and guarded hot box.
EN ISO 9223	Corrosion of metals and alloys - Corrosivity of atmospheres - Classification, determination and estimation.
ISO 15799	Soil quality. Guidance on the ecotoxicological characterization of soils and soil materials.
CEN/TS 16637-2	Construction products - Assessment of release of dangerous substances - Part 2: Horizontal dynamic surface leaching test.

ANNEX A – SPECIAL COMPONENTS TEST METHODS

This annex establishes special test methods of components used for the verification of constancy of performance.

A.1 Dimensions of the boards

Dimensions of the boards are measured according to the relevant hEN (see table 1.2) or EAD.

When the hEN or EAD does not give an assessment method, the dimensions of the board shall be measured according to the relevant sections of EN 12467, EN 15283-1, EN 15283-2 or EN 520.

A.2 Density of the boards

Density of the boards are measured according to the relevant hEN (see table 1.2) or EAD.

When the hEN or EAD does not give an assessment method, the dimensions of the board shall be measured according to the relevant sections of EN 12467, EN 15283-1, EN 15283-2 or EN 520.

A.3 Density of mortars

A.3.1 Product as delivered

Pastes and liquids

This is measured at (23 ± 2) °C in a 1000 cm³ cylinder.

Powders

This is measured at (23 ± 2) °C in a 500 cm³ cylinder.

Method of operation

The results are recorded after maximum packing down on a vibrating table and levelling of the surface. The results are expressed in kg/m³ (mean value of 3 tests).

A.3.2 Fresh mortar

Preparation of mortar

The mortar is prepared in the laboratory according to manufacturer's instructions.

In most cases, manufacturers shall specify both spray (large surfaces) and trowel (small surfaces) applied mortar. Therefore, unless the ETA-Applicant specifies the method of application, or the most onerous application method can be determined, tests shall be conducted with both spray and trowel applied material and the density of both shall be measured. The ETA should specify the densities and their tolerances for trowel and spray applied renderings.

Method of operation

The apparent density is determined using a 1 litre cylindrical container, previously tared (mass M_0 in g). The container is filled with paste and after compacting down, wiped off and weighed (mass M_1 in g). The density of the paste (in kg/m³) is equal to $M_1 - M_0$. The density of the paste is measured immediately after mixing.

A.3.3 Hardened mortar

The specimens shall be prepared according to section J.1.2 using an adequate formwork or mould.

Apparent density of hardened mortar shall be determined by measuring mass and dimensions. The accuracy for weighing is 1/1000 and for the dimensions is 1/100.

Alternative method according to EN 1015-10 can be used.

A.4 Particle size grading

Pastes

Particle size grading is established from a sample of fillers removed from the manufactured product after washing on a sieve, mesh size 0,08 mm or after any other suitable and pertinent preparation. The test is carried out after drying at least 105 °C.

Powders

Particles size grading is established from a sample of fillers removed from the manufactured product.

Method of operation

The test is performed using air stream sieving on an about 50 g specimen for 5 minutes per sieve. The curve is traced from 0,04 (for powders) or 0,08 (for pastes) to 4 mm with at least 5 intermediate sieves.

A.5 Dry extract (only pastes and liquids)

A.5.1 Lime and polymer based products

This is determined after placing the sample in a ventilated oven set at (105 ± 5) °C until a constant mass is obtained.

The mass is regarded as constant if the difference in mass between two successive weightings, one hour apart, does not exceed 0,1 g.

Initial weighing for testing:

- 2 g for liquid products (impression, etc.),
- 5 g for products in paste form.

The results are expressed as a percentage relative to the initial mass (mean value of 3 tests).

Alternative method according to EN 480-8 can be used.

A.5.2 Silicate based products

The dry extract is determined by the following method:

A - Initial weighing of approximately 5 g (product in the as-delivered state) on an aluminium sheet, approximately 100 mm x 100 mm, 2/3 covered.

B – Pre-dry for 1 hour at (125 ± 10) °C. Dry for 2 hours at (200 ± 10) °C.

C - Final weighing.

Weighing accuracy shall be within 5 mg.

The difference in mass from the initial weighing is accounted for by volatile components including water of crystallization.

The results are expressed as a percentage relative to the initial mass (mean value of 3 tests).

Alternative method according to EN 480-8 can be used.

A.6 Ash content

A.6.1 Base-coat and finishing coats

Pastes and liquids

The ash content is determined on the same samples as those on which the dry extract has been measured.

Powders

The ash content is determined at 450 °C and 900 °C on a sample of approximately 5 g pre-dried at (100 ± 5) °C or at (200 ± 5) °C for silicate based products, to constant mass. The mass is regarded as constant if the difference in mass between two successive weightings, one hour apart, does not exceed 0,1 g.

Method of operation

- The sample is placed in a tared crucible either fitted with a lid or enclosed in a leak-tight container and the whole is weighed,
- After the lid has been removed, where necessary, the crucible is placed in the oven maintained at ambient temperature,
- The temperature of the oven is then raised to (450 ± 20) °C (ash content at 450 °C) or to (900 ± 20) °C (ash content at 900 °C) and maintained at that temperature for 5 hours,
- The crucible is allowed to cool down to room temperature in the desiccators before being weighed.

The results are expressed as a percentage relative to the initial mass after drying (mean value of 3 tests).

Note: the tolerances at 900 °C may become larger, taking account of the products' composition.

A.6.2 Glass fibre reinforcement mesh

The ash content is determined at (625 ± 20) °C on three 100 mm square samples, cut parallel to the yarn and at least 100 mm apart from the side to constant mass.

The result is expressed as a percentage relative to the initial mass.

Alternative method according to EAD 040016 can be used.

A.7 Modulus of elasticity, tensile strength and elongation

A.7.1 Products with a thickness greater than 5 mm

Preparation and storing of test samples

The mortar is prepared by mixing as described in section A.3.2.

Test samples, conforming to the dimensions defined in the paragraphs below, are prepared in metal moulds in two layers.

Each layer is compacted into position by dropping alternately each side of the mould from a height of 5 mm approximately ten times. The test samples are then levelled with a metal ruler.

The test samples are removed from the mould after 24 h.

They are then stored for at least 28 days at (23 ± 2) °C and (50 ± 5) % relative humidity.

Dynamic modulus of elasticity (Resonance frequency method)

The dynamic modulus of elasticity is determined on prismatic test samples measuring 25 mm x 25 mm x 285 mm.

The test is carried out on 3 samples prepared as described above.

The individual values of the apparent density (in kg/m³) and the modulus (in MPa) of the 3 test samples and the mean value of the results obtained are noted.

The principle of the measurement consists of measuring the basic resonance frequency of a test sample under longitudinal vibration.

1 – Apparatus:

The apparatus used for carrying out this measurement comprises:

- a) A variable frequency oscillator, with a frequency range of 20 kHz and an accuracy of 1%.
- b) An electromagnetic vibrator which may or may not be in mechanical contact with the test sample; its mass shall be very light compared to that of the test sample.
- c) A receiver, an electromechanical transducer and an amplifier; its mass shall be very light compared to that of the test sample.

The resonance frequencies of the vibrator and the receiver shall not fall between 0,5 kHz and 20 kHz.

- d) An amplifier.
- e) An apparatus indicating the vibration amplitudes (voltmeter, milliammeter, oscilloscope).
- f) A very narrow support on which the test sample rests during the measurement, which shall not hinder the longitudinal vibration of the test sample and which shall be in the nodal plane.

2 - Testing

The sample is centred on the support. The vibrator and the receiver are placed as shown in the figure below:

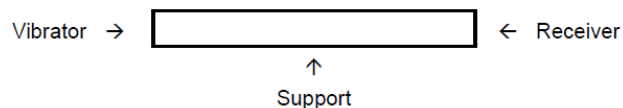

It is important that the ends of the test piece are free to vibrate in an axial direction. The vibration generator and the receiver, if they are in contact with the test piece, should exert an equal very weak stress on the two ends. In this case, it is recommended to weakly bond the mobile part of the vibrator to the sample using a coupling product (mastic). The same applies for the receiver.

The variable frequency oscillator supplies the vibrator and the test piece vibrates longitudinally. The vibrations are collected by the receiver and after amplification their amplitude is shown on a dial (voltmeter, milliammeter, oscilloscope). For most frequency ranges, the vibration amplitude is quite small. But for certain frequencies, the displacement becomes appreciable. The resonance conditions are created when maximum amplitude is obtained on the indicating dial.

The frequency of the basic longitudinal resonance corresponds to the lowest frequency for which a maximum amplitude is obtained (for the higher harmonic frequencies a resonance is also produced).

Two measurements are carried out: the vibration is produced successively at the two ends of the test piece. The mean value is recorded. If the difference between the two values is higher than 5 % the vibrations are restarted.

The measurements of the mass and dimensions of the test piece are needed to calculate the modulus. The accuracy for weighing is 1/1000 and for the dimensions 1/100.

3 - Expressing the results:

As the basic longitudinal resonance frequency, the mass and the dimensions of the test piece are known the dynamic modulus of elasticity is determined using the following formula:

$$E_d = 4 \cdot L^2 \cdot F^2 \cdot \rho \cdot 10^{-6}$$

E_d = Longitudinal dynamic modulus of elasticity in Newton per square millimetre.

L = Length of test piece in metres.

F = Longitudinal resonance frequency in Hertz.

ρ = Mass per unit volume in kg/m³.

A.7.2 Products with a thickness up to 5 mm

Preparation and storing of test samples:

The mortar is prepared by mixing as described in section A.3.2.

The tests are performed on test samples measuring 3 mm x 50 mm x 300 mm.

Moulds for the samples are made using appropriately positioned 3 mm thick strips of extruded polystyrene adhered to expanded polystyrene boards.

After the mortar (without reinforcement) has dried, test samples are cut from the polystyrene with hot wire.

The test sample is subjected to a tensile test until it breaks using a suitable machine which records the tensile stress and elongation. The distance between the jaws of the machine is 200 mm. The sample is held between the jaws with the interposition of pads.

The tensioning speed is 2 mm/minute.

The tests are carried out on five samples stored for at least 28 days at (23 ± 2) °C and (50 ± 5) % RH and on five samples which have undergone the hygrothermal test (placed in the window of the specimen).

A.8 Shrinkage

The measurement is carried out on three samples of product measuring 20 mm x 40 mm x 160 mm prepared and stored as described in section A.3.2, by inserting measuring spindles in the front end (10 mm x 40 mm) of the samples.

Measurements are carried out at regular intervals. The value after 28 days is recorded. In addition, if there is doubt in the curve associated with stabilisation, the test is continued and the value after 56 days is recorded.

Alternative method according to EN 12617-4 or EN 12808-4 can be used.

A.9 Mass per unit area of reinforcement mesh

The mass per unit area is determined by measuring and weighting a one metre length of mesh.

For reinforcement in roll form, the width of the sample should be the same as the roll width.

The result is expressed in g/m².

Alternative method according to EAD 040016 can be used.

A.10 Mesh size and number of filaments

The mesh size is determined by measuring the distance between 21 yarns (e.g. 20 mesh) in warp and in weft direction.

The mesh opening is calculated by subtracting the thickness of the yarn from the mesh size.

Alternative method according to EAD 040016 can be used.

A.11 Tensile strength and elongation of reinforcement mesh

Tensile strength and elongation of the reinforcement mesh is determined according to EN 13496 in the following conditions:

- As-delivered state: after conditioning the samples at (23 ± 2) °C and (50 ± 5) % RH for at least 24 hours.
- After ageing: after immersion the samples for 28 days in the alkaline solution at (23 ± 2) °C. 20 samples (10 in the weft and 10 in the warp direction) in 4 litres solution.

Alternative method according to EAD 040016 can be used.

ANNEX B – REACTION TO FIRE

B.1 General

B.1.1 Principle

The determination of reaction to fire of the external wall kits is based on testing of “the worst case” - the most critical configuration in sense of reaction to fire. According to the rules described further in the text, the classification obtained on the most critical configuration of the external wall kit components is valid for all configurations of external wall kit components having better performance in sense of reaction to fire.

For the particular parts of the external wall kit components, the following principles apply:

- The kit components material with the highest amount of organic content⁶ (if there are only differences in the amount of organic content but no difference in the organic component itself) or the highest PCS value (according to EN ISO 1716) shall be tested.
- In addition, each kit components material selected for testing according to the previous point shall have the lowest amount of flame retardants.

B.1.2 Physical properties influencing the reaction to fire behaviour

- Type of rendering system components (composition, thickness, mass per unit area).
- Type of board (composition, thickness, density).
- The organic content of the binder and of any organic additive of the boards or rendering system components; this can be checked by providing the formulation of the component, by performing suitable characterization tests or by determining the glow loss or net calorific value.
- Type and amount of flame retardant.
- Type and nature of board-fixings and subframe components.

Note: Fire breaks are important for the behaviour of the whole facade system and cannot be assessed on the basis of SBI-testing. The influence can only be observed during a large-scale test. Therefore, breaks are not included in the mounting and fixing rules for the SBI-test.

Although the rest of this annex applies the “worst case scenario” for deciding what to test, it is accepted that, where the manufacturer produces a range of kit components having different overall classifications, it may group these together into a number of different sub-groups (e.g. each sub-group corresponding to a different overall classification) with the ‘worst case scenario’ being identified for each sub-group.

Components of a kit, where these require separate assessment (as opposed to being tested as part of the kit as a whole), which are classified A1 without testing according to Decision 96/603/EC (as amended) do not need to be tested.

B.2 Testing according to EN ISO 1182

This test method is relevant for classes A1 and A2.

Using this test method, only the substantial components of the kit need to be tested. ‘Substantial components’ are defined by thickness (≥ 1 mm) and/or mass per unit area (≥ 1 kg/m²).

In the following, the base-coat, reinforcement mesh, finishing coats, boards, subframe components, thermal insulation product and breather membrane are considered as “Substantial components”.

⁶ When relevant, the manufacturer is responsible for the information on organic content per unit area. If the information is not available, the PCS value shall be tested to decide about the worst case.

Parameters relevant given in section B.1 shall be applied.

B.2.1 Base-coat and finishing coat

The reaction to fire behaviour of the base-coat and finishing coat not falling under EC Decision 96/603/EC (as amended) shall be tested taking into account the principles given in section B.1.

The test results can be directly applied to all variants with the same base-coat and finishing coat with a lower amount of organic components. When the subject of the directly applied result contains a flame retardant, it shall be of the same type and its content shall be at least that of the product tested.

Differences greater than tolerances $\pm 10\%$ concerning the density shall be considered by testing the lowest and the highest density.

B.2.2 Board, thermal insulation product, breather membrane and subframe components

For kits expected to be classified as A1 or A2, it is anticipated that only boards, thermal insulation product, breather membrane and subframe components with reaction to fire class A1 or A2 will form part of the kit. For testing these components, reference shall be made to the relevant product standards or other relevant documents.

Differences greater than tolerances $\pm 10\%$ concerning the density shall be considered by testing the lowest and the highest density.

B.3 Testing according to EN ISO 1716 (PCS value)

This test method is relevant for classes A1 and A2.

This test method shall be performed to all components of the kit except for cases which are classified as A1 without testing.

Parameters relevant for this test method are: composition (when performing calculation of the PCS_s-value), density or mass per unit area and thickness. Mechanical fixings and ancillary materials which are not continuous but discrete components of external wall kit do not need to be considered for testing and for the calculation of the PCS_s.

B.3.1 Base-coat and finishing coat

In general, when performing calculations of the unit area referred PCS_s-value (related to the surface) the variant that provides the highest PCS_s-value shall be considered.

The test shall be performed in accordance with the principles specified in section B.1 applied to each component.

It is not necessary to test a base-coat or finishing coat with different grain sizes if the organic content is the same as or lower than that of the tested component.

The test results can be directly applied to all variants with the same base-coat and finishing coat but with a lower amount of organic components. When the subject of the directly applied result contains a flame retardant, it shall be of the same type and its content shall be at least that of the product tested.

B.3.2 Board

For testing the board, reference shall be made to the relevant product standards or EAD.

It is not realistic to require that each board of the same material is tested within the classification of a kit. If the board come from different manufacturers and/or are of different thickness, density and formulation from those used in the testing, these may be used subject to the requirements of class A1 and A2 still being fulfilled. It shall be proved by calculation the kit, together with the actual board used in end use application, still fulfils the requirements concerning the PCS-value of the whole product. For example, it is sufficient to

determine the PCS-value of the board and if this is lower than the originally tested product then it is acceptable to use the alternative board instead of that used in the original test.

Note: Information relating to alternative board of the same material to that originally tested may be evaluated on the basis of the supplier's evidence provided within the context of its CE marking.

B.3.3 Reinforcement

Each type of reinforcement shall be tested according to EN ISO 1716. For reinforcement that is randomly dispersed (e.g. fibres) in the render then it shall be tested as part of the render.

B.3.4 Thermal insulation product and breather membrane

For testing the insulation product or breather membrane, reference shall be made to the relevant product standards or other related documents.

It is not realistic to require that each insulation product or breather membrane of the same type of material is tested within the classification of a kit. If the product or breather membrane come from different manufacturers and/or are of different thickness, density and formulation from those used in the testing, these may be used subject to the requirements of class A1 and A2 still being fulfilled. It shall be proved by that the kit, together with the actual product or breather membrane used in end use application, still fulfils the requirements concerning the PCS-value of the whole product. For example, it is sufficient to determine the PCS-value of the insulation product or breather membrane and if this is lower than the originally tested product then it is acceptable to use the alternative insulation product or breather membrane instead of that used in the original test.

Note: information relating to alternative insulation product or breather membrane of the same type of material to that originally tested may be evaluated on the basis of the supplier's evidence provided within the context of its CE marking.

B.4 Testing according to EN 13823 (SBI-test)

This test method is relevant for classes A2, B, C and D (in some cases also for A1).

Associated mounting and fixing rules for the SBI test shall be in accordance with the relevant harmonized specifications of the boards (see table 1.2).

Parameters which are relevant for this test method:

- Type of kit components (composition, dimensions, density).
- Amount of organic content of the kit components.
- Amount of flame retardant, if any.

In principle, it is desirable to find the test specimen configuration that gives the worst case concerning the reaction to fire test results. In the test procedure according to EN 13823, values for the rate of heat release, total heat release, lateral flame spread, rate of smoke release, total smoke release and burning droplets are determined.

The test specimen shall be prepared with the kit components with the highest organic content or PCSs-value per unit area.

B.4.1 Specific information

The kits are tested in a limited number of configurations to cover the influence of the parameters given previously.

The boards can be cut to size as indicated in the relevant harmonized specifications of the boards (see table 1.2).

The board-fixing and subframe shall be fixed to the substrate through fixings adapted to the type and material of the substrate.

By testing one specific rendering system representing a range of different rendering systems, the following rules shall be applied to discriminate the composition, which is able to represent a range of rendering systems:

- The rendering systems components to be used for preparing the specimen, taking account of the permissible combination(s) allowed by the manufacturer, shall be determined in accordance with the principles specified in section B.1.
- For a base-coat and a finishing coat having an organic content less than or equal to 5% (related to the mass in dried condition as used in the end use application), only the lowest thickness needs to be used for preparing the test specimen.
- For a base-coat or a finishing coat having an organic content higher than 5%, both the lowest and the highest thickness of the layer of the base-coat and finishing coat shall be used for preparing the test specimens.

Regardless of the organic content, only the highest thickness of a base-coat and a finishing coat shall be tested on board with class A1 or A2-s1,d0.

When the only difference in coatings is thickness and it is 0,5 mm or less, the coatings may be considered to be the same.

B.4.2 Direct application rules of test results

The test result (classification) shall remain valid, without test:

- For rendering systems components:
 - with equal or lower organic content or PCSs-value per unit area,
 - with equal or higher content of the same type of flame retardants,
 - with base-coat and finishing coat with equal or greater thickness if the organic content is equal or less than 5%,
 - base-coat and finishing coat having more than 5% organic content:
 - with equal or greater thickness if only the lowest thickness has been tested,
 - or, with thickness between those evaluated, provided that the worst result of the two thickness tested is used for intermediate thickness.
- For boards:
 - of the same material,
 - of greater dimensions (height and width),
 - the range of boards between lowest and highest density, for boards reaction to fire different to class A1 or A2,
 - with equal or lower organic content or PCSs-value per unit area,
 - with equal or higher content of the same type of flame retardants.
- For other higher density of board-fixings.
- For other higher thickness of air space.
- When the test is carried out without insulation layer, the test result is applicable provided that the insulation layer placed behind the board in the end-use situation is made of materials of class A1 or A2-s1,d0 (e.g. mineral wool).

- When the test is carried out with mineral wool insulation shall be valid for:
 - all other greater thickness of mineral wool insulation layer with the same density and the same or better reaction to fire classification;
 - the same type of panel used without insulation, if the substrate chosen according to EN 13238 is made of panel with Euro-class A1 or A2 (e.g. fibres-cement panel).
- The results of reaction to fire tests, where a combustible insulation material was used as substrate, are also valid for end-use applications of the tested product without insulation on solid mineral substrates of class A1 or A2-s1,d0 like masonry or concrete.
- The test result of a test with non-fire treated timber frame shall be valid, without test, for the same type of board and rendering system used with aluminium or steel frame.

Note: other aspects given in the relevant hEN standards or EAD for the kit component materials should be also taken into account.

B.5 Testing according to EN ISO 11925-2

This test method is relevant for classes B, C, D and E.

Parameters which are relevant:

- Type of kit components (composition, dimensions, density).
- Amount of organic content of the kit components.
- Amount of flame retardant, if any.

For boards with covered edges, the specimens shall be prepared both with covered edges and edges without covering (cut edges).

The tests are performed with surface flaming of the front side and possibly edge flaming of the test specimen turned 90° according to the rules of standard EN ISO 11925-2.

Besides, the principles specified in section B.1 shall be applied.

ANNEX C - RESISTANCE TO FIRE. DIRECT APPLICATION RULES

Direct application rules of the resistance to fire test results shall be according to EN 1364-1.

Besides, the resistance to fire test results can be extended to kits that fulfil simultaneously the following conditions:

- with the same material of external-board,
- with the same material of internal-boards and intermediate-boards,
- with the same material of rendering system or with less organic content,
- with the same material of thermal insulation,
- belonging to the same kit family as described in section 1.1.

In case of kits only differing from the presence of the rendering system, the results of tests obtained for kits without the rendering system can be valid for kits with the rendering system.

In case of kits belonging to different families that only differ in the number of internal layers but keep the external-internal order of their common components in both sides, the results of tests obtained for the worst kit family can be valid for other kit families with more layers that keep the described order (e.g. results obtained for family 1 can be valid for families 3 and 4, results for family 3 can be valid for family 4).

ANNEX D – FAÇADE FIRE PERFORMANCE ASSESSMENT METHODS

Country	Assessment method
Austria	ÖNORM B 3800-5
Czech Republic	ČSN ISO 13785-1
Denmark, Sweden, Norway	SP Fire 105
Finland	<ul style="list-style-type: none"> • SP Fire 105 • BS 8414
France	LEPIR 2
Germany	<ul style="list-style-type: none"> • DIN 4102-20 Complementary reaction-to-fire test for claddings of exterior walls, • Technical regulation A 2.2.1.5
Hungary	MSZ 14800-6:2009 Fire resistance tests. Part 6: Fire propagation test for building façades
Ireland	BS 8414 (BR 135)
Poland	PN-B-02867:2013
Slovak Republic	ISO 13785-2
Switzerland, Lichtenstein	<ul style="list-style-type: none"> • DIN 4102-20 • ÖNorm B 3800-5 • Prüfbestimmung für Aussenwandbekleidungssysteme
UK	BS 8414 -1:2015 and BS 8414-2:2015

ANNEX E – WATER ABSORPTION BY CAPILLARITY TEST

E.1 Preparation of the test specimen

Test shall be carried out on at least three specimens.

Specimens shall have a surface area of at least 200 mm x 200 mm, and installed according to the manufacturer's instructions.

The following aspects should be recorder in the test report:

- thickness of each layer of the specimen;
- weigh of the whole specimen;
- summary of the manufacturer's instruction used for the specimen installation.

As given in section 2.2.6.1, tests shall be carried out for:

- the whole rendering system (finishing coat and base-coat with the reinforcement mesh) to be considered in the ETA, and
- for the reinforced base-coat alone.

The edges of the specimens (including the board) should be sealed against water, to ensure that during subsequent testing, only the front face of the specimen is subject to water absorption.

E.2 Conditioning of the specimens

The prepared specimens are conditioned for 7 days at (23 ± 2) °C and (50 ± 5) % RH.

They are then subject to a series of 3 cycles comprising the following phases:

- Phase 1: 24 h partial immersion in a water bath (tap water) at (23 ± 2) °C

The specimens are immersed face downwards, to a depth of 2 to 10 mm, the depth of immersion depends upon surface roughness. To achieve complete wetting of rough surfaces, the specimens shall be tilted as they are introduced into the water. The depth of immersion can be regulated in the water tank by means of a height-adjustable slat.

- Phase 2: 24 h drying at (50 ± 5) °C

If interruptions are necessary, e.g. at weekends or holidays, the specimens are stored at (23 ± 2) °C and (50 ± 5) % RH after the drying at (50 ± 5) °C.

After the cycles, the specimens are stored for at least 24 h at (23 ± 2) °C and (50 ± 5) % RH.

E.3 Test procedure

To start the capillarity test, the specimens are again immersed in a water bath as described above.

The specimens are weighed after 3 minutes immersion in the bath (reference weight) and then after 1 hour and 24 hours. Prior to the second and subsequent weighing, water adhering to the surface of the specimen is removed with a damp sponge cloth.

E.4 Test results

Calculation is undertaken to determine the mean value of water absorption per square metre after 3 min, 1 hour and 24 hours of the three specimens.

ANNEX F – ADDITIONAL CRITERIA FOR WIND SUCTION AND PRESSURE LOAD TESTS

The number of tests depends on the combination of parameters presented for the assembled kit.

At least, the mechanically weakest design shall be tested.

F.1 Preparation of the test specimen

The test specimen shall be mounted in the test equipment in accordance with the manufacturer's instructions.

When necessary (e.g. for families 3 or 4 with double walls), the test specimen may be composed exclusively by the external leaf. Besides, due to it is the worst case, it is possible to carry out the test only with the external partial composition of the assembled kit (e.g. external subframe, external-board, and optionally the flexible sheet for waterproofing and the rendering system).

The test specimen is defined as follows:

- The assembled kit must be fixed to the test equipment with the worst or the most representative anchors (e.g. minimum diameter and maximum distance between them).
- The dimensions of the test specimen depend on the assembled kit composition (the span between structural floors and the span between vertical profiles). At least, one maximum span between structural floors and three vertical profiles (two spans between profiles) must be tested. As reference, the dimensions of the test specimen, indicated in section L.1 of Annex L for the hygrothermal behaviour test, may be used.

In the case to include a generic opening, the position and dimensions may also be the indicated in section L.1 of Annex L. Other positions and dimensions are also possible. The generic opening shall not be a weak point and shall therefore be chosen accordingly. At least, the generic opening to be used in the test must have air permeability higher than the maximum test pressure chosen for the assembled kit test.

The sensors for the measure of the deflection shall be positioned, at the external surface of the test specimen positioned on the central vertical profile zone and at least on:

- the middle board surface between two vertical profiles,
- the middle of the central vertical profile,

The deflection measures shall be reported in tabular or graphic form as a function of the load.

F.2 Observations

Failure is defined by any one of the following events:

- Any board, board-fixing or profile breaks.
- Any board, board-fixing or profile presents a significant permanent deflection.
- Falling of detached components.
- Failure or detachment of the kit subframe.
- The measurement equipment system limit.

Additionally, any crack on the rendering system or the external-board must be observed and noted.

F.3 Test results

The test result is:

- The failure load Q.
- The type of failure.
- The value of maximum permanent deflection (after 1 minute recovery), the maximum deflection of the test specimen and the load and sensor position for this maximum permanent deflection and maximum deflection.

The test results are only valid for the assembled kit tested.

F.4 Test specimen description

It is necessary to describe the test specimen by giving details about:

- Maximum distance between structural floors.
- Profiles (material, geometry and distance between two profiles).
- Boards (material and geometry).
- Board-fixing (material and geometry and number and disposition of fixings).
- Fixings between the test equipment and the assembled kit (position, generic type, material and geometry).
- When relevant, the rendering system (finishing coat and base-coat) used.

ANNEX G – EXTERNAL ECCENTRIC LOAD RESISTANCE TEST

The principle is to establish the effects of external eccentric loads on the assembled kit due to exterior-finishing mechanically fixed to the external subframe of the kit.

At least, the mechanically weakest design shall be tested.

The tests shall be carried out under normal environmental laboratory conditions ($(20 \pm 10) ^\circ\text{C}$ and $(50 \pm 20) \%$ relative humidity).

G.1 Preparation of the test specimen

The test specimen is composed of:

- One segment of vertical profile with length equal to the maximum distance between two fixing devices (L_{\max}) defined (see figure G.1).
- One piece of external-board with the same length of the profile and width equal to the double of the wing profile (Z). The board must be fixed to the vertical profile in accordance with the kit manufacturer instructions.
- Fixing device (e.g. brackets, punctual fixings, etc.). The fixing device of the test specimen must not constitute the weak point and therefore it must be chosen accordingly.

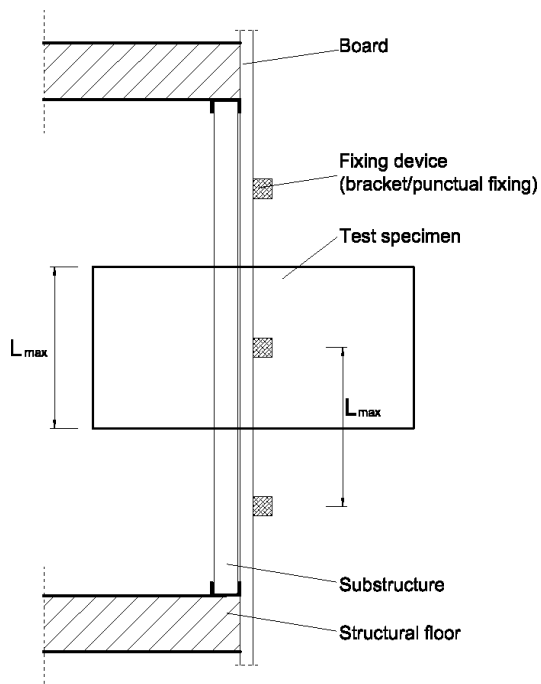

Figure G.1: Preparation of the test specimen.

G.2 Exterior-finishing fixing devices

One test for each fixing device defined by the manufacturer to be used with the kit shall be done.

Fixing devices may be mechanically fixed to the subframe by only one fixing (punctual fixing) or by two or more points of fixings (brackets or profiles fixed by several screws). See figures G.2.

In case of punctual fixing device, the following characteristics shall be known:

- Generic type.
- Geometry (diameter and length).
- Material.

In case of fixing device with two or more points of fixings, the following characteristics shall be known:

- Geometry of the bracket or profile: thickness (e), height (h), width (a) and wing length (w).
- Generic type of the screws between the bracket or profile and the kit vertical profile
- Geometry of the screws.
- Number and position of screws.
- Screws and bracket/profile materials.

G.3 Test procedure

A force is exerted on the fixing device as shown in figure G.2, at a speed rate of 5 mm/min until failure occurs.

The force-displacement shall be measured and reported in tabular or graphic form.

At least 3 tests shall be carried out.

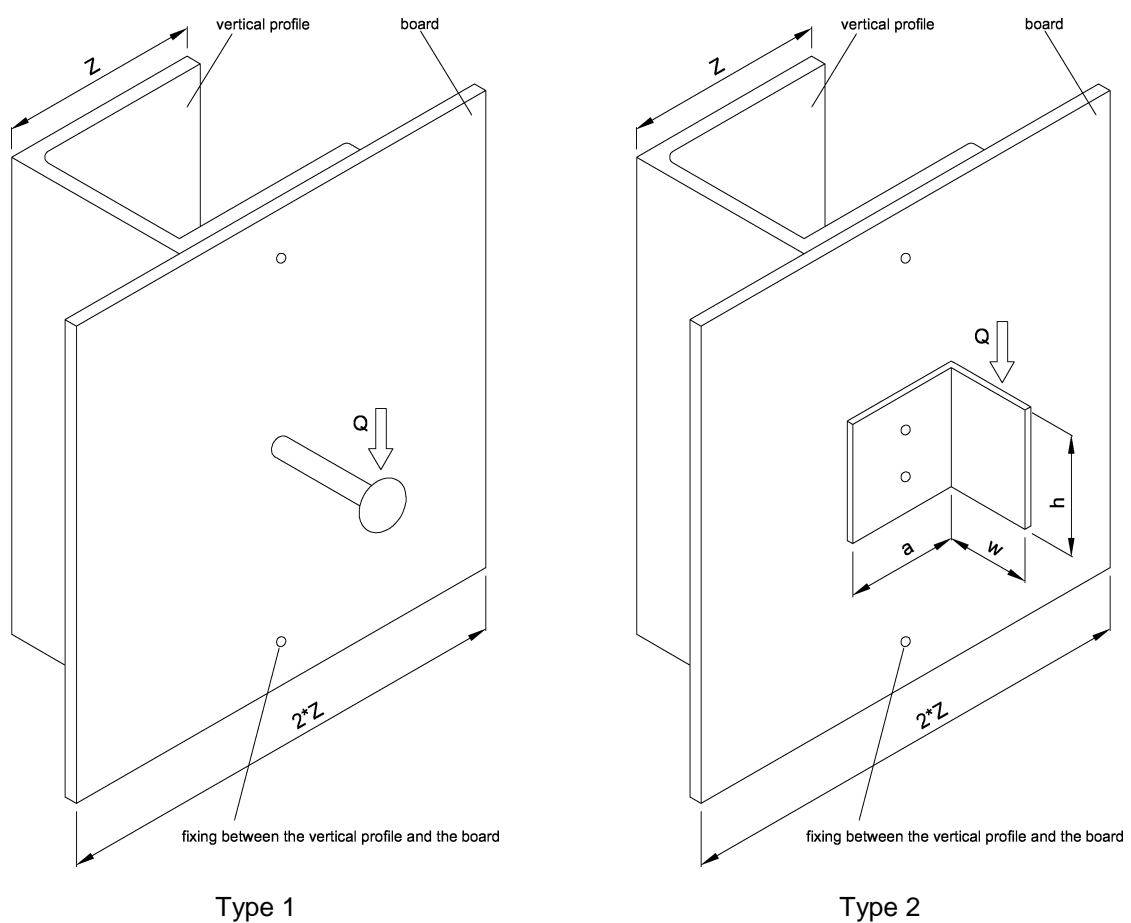

Figure G.2: Examples of the test preparation.

G.4 Observations during the test

Failure is defined by anyone of the following events:

- The fixing device or the screws break.
- The fixing device reaches a maximum displacement of 15 mm.
- The board or vertical profile breaks.

In the case of the failure occurs by means of the fixing device, the manufacturer will decide whether repeat the tests with other fixing devices or limit the performance of the kit to the ultimate failure load obtained.

G.5 Test results

The results are expressed in N.

The test report shall detail the following in accordance with Annex O:

- Each F_{mc} value for 1 mm displacement.
- The mean F_{mcs} value for 1 mm displacement.
- Each F_{mc} value for 3 mm displacement.
- The mean F_{mcs} value for 3 mm displacement.
- The characteristic F_{mcSC} values giving 75 % confidence that 95 % of the test results will be higher than this value.
- The maximum load Q for which test specimen fails.
- The mode of failure description.

ANNEX H – EXTERNAL IMPACT RESISTANCE TEST

H.1 General

The principle is to establish the impact resistance of the kit considering hard body and soft body impacts. Besides, it is established the impact use categories to correspond to the degree of exposure to impacts in use.

The bodies to impact and the test equipment are given in EOTA TR 001. The points of impact shall be selected taking into account the behaviour of the rendering system, board and the substrate, varying according to whether the impact point is or is not located in an area of greater rigidity (at less than 50 mm from the edge of the board).

Hard body impacts are:

- H1 and H2 (1 J and 3 J respectively), carried out with the steel ball weighing 0,5 kg and from a height of 0,20 m and 0,61 m respectively (at least in three locations).
- H3 (10 J), carried out with the steel ball weighing 1,0 kg and from a height of 1,02 m (at least in three locations).

Soft body impacts are:

- Small soft body S1 and S2 (10 J and 60 J respectively), carried out with the soft ball weighing 3,0 kg and from a height of 0,34 m and 2,04 m respectively (at least in three locations).
- Large soft body S3 and S4 (100 J and 400 J respectively), carried out with the spherical bag weighing 50,0 kg and from a height of 0,61 and 0,82 m respectively (at least in the space between two profiles).

Note: The manufacturer may consider other energy values for the hard and soft body impacts. Any change shall be given in the ETA.

At least, the mechanically weakest design shall be tested.

The size of the test specimen shall be chosen to carry out all the impacts given in table H.1.

The dimensions of any indentation and any damage caused shall be reported.

H.2 Test procedure

Test procedure can be carried out using one of following options:

1. When the impact resistance is chosen by the manufacturer or it is known, using the impact tests given in table H.1 for this impact resistance chosen or known.
2. When the impact resistance is not known, starting with lowest impact bodies and continue increasing the impacts, with the aim of obtaining the maximum impact resistance.

Table H.1: Hard and soft body impact tests.

External impacts and assessment
--

			Category IV	Category III	Category II	Category I
Hard body impact	H1	<ul style="list-style-type: none"> Weight: 0,5 kg Impact: 1 J (height 0,20 m) No. impacts: 3 Position of impacts: three different locations 	Not penetrated (2) Not perforated (3)	---	---	---
	H2	<ul style="list-style-type: none"> Weight: 0,5 kg Impact: 3 J (height 0,61 m) No. impacts: 3 Position of impacts: three different locations 	---	Not penetrated (2) Not perforated (3)	No deterioration (1)	No deterioration (1)
	H3	<ul style="list-style-type: none"> Weight: 1 kg Impact: 10 J (height 1,02 m) No. impacts: 3 Position of impacts: three different locations 	---	---	Not penetrated (2) Not perforated (3)	No deterioration (1)
Soft body impact	S1	<ul style="list-style-type: none"> Weight: 3 kg Impact: 10 J (height 0,34 m) No. impacts: 3 Position of impacts: three different locations 	No deterioration (1)	No deterioration (1)	---	---
	S2	<ul style="list-style-type: none"> Weight: 3 kg Impact: 60 J (height 2,04 m) No. impacts: 3 Position of impacts: three different locations 	---	---	Not deterioration (1)	Not deterioration (1)
	S3	<ul style="list-style-type: none"> Weight: 50 kg Impact: 300 J (height 0,61 m) No. impacts: 1 Position of impacts: At least in the centre point of an external-board 	---	---	No deterioration (1)	---
	S4	<ul style="list-style-type: none"> Weight: 50 kg Impact: 400 J (height 0,82 m) No. impacts: 1 Position of impacts: At least in the centre point of an external-board 	---	---	---	No deterioration (1)
<p>(1) Superficial damage, provided there is no cracking, is considered as showing "no deterioration" for all the impacts. Collapse or any other dangerous failure is not allowed.</p> <p>(2) The test result is assessed as being "penetrate" if there is any cracking penetrating to be observed in the base-coat or in the board (to be also observed by the rear side) in at least 2 of 3 impacts. Superficial cracking (no penetrating) is allowed. Collapse or any other dangerous failure is not allowed.</p> <p>(3) The test result is assessed as being "perforated" if there is a destruction of the rendering system that is shown up to a level beyond the reinforcement mesh or the board is broken (to be also observed by the rear side) in at least 2 of 3 impacts. Collapse or any other dangerous failure is not allowed.</p>						

H.3 Definition of the impact use categories (informative)

The categories given in table H.2 correspond to the degrees of exposure in use. They do not include an allowance for acts of vandalism.

Table H.2: Impact use categories.

Category	Use
I	A zone readily accessible at ground level to the public and vulnerable to hard body impacts but not subjected to abnormally rough use. (e.g.: Façade bases in buildings sited in public locations, such as squares, schoolyards or parks. Cleaning gondolas may be used on the façade).
II	A zone liable to impacts from thrown or kicked objects, but in public locations where the height of the kit will limit the size of the impact; or at lower levels where access to the building is primarily to those with some incentive to exercise care (e.g.: Façade bases in buildings not sited in public locations (e.g. squares, schoolyards, parks) or upper façade levels in buildings sited in public locations that occasionally can be hit by a thrown object (e.g. ball, stone, etc.). Cleaning gondolas may be used on the façade).
III	A zone not likely to be damaged by normal impacts caused by people or by thrown or kicked objects (e.g.: Upper façade levels in buildings (not including base) not sited in public locations, that occasionally can be hit by a thrown object (e.g. ball, stone, etc.). Cleaning gondolas should not be used on the façade).
IV	A zone out of reach from ground level (e.g. High façade levels that cannot be hit by a thrown object. Cleaning gondolas should not be used on the façade).

ANNEX I – RESISTANCE TO HORIZONTAL POINT LOAD

The external wall kit shall be tested under a static load 500 N applied for one minute horizontally through two squares of 25 mm x 25 mm x 5 mm space apart (distance 440 mm) on any part of the external-board with the rendering system (representing one person standing on a ladder leaning against the external surface) at room temperature and according to figure I.1.

To define the mechanically weakest case of the assembled kit the following aspects should be taken into account:

- The mechanically weakest external-board (e.g. minimum thickness, minimum bending strength, etc.).
- The mechanically weakest board-fixings (e.g. minimum thickness, minimum mechanical material characteristics, etc.).
- Minimum density of board-fixings.
- The mechanically weakest subframe components (e.g. minimum thickness, minimum mechanical material characteristics, etc.).
- Maximum span between profiles.

The mechanical properties of the components used for the test is to be known.

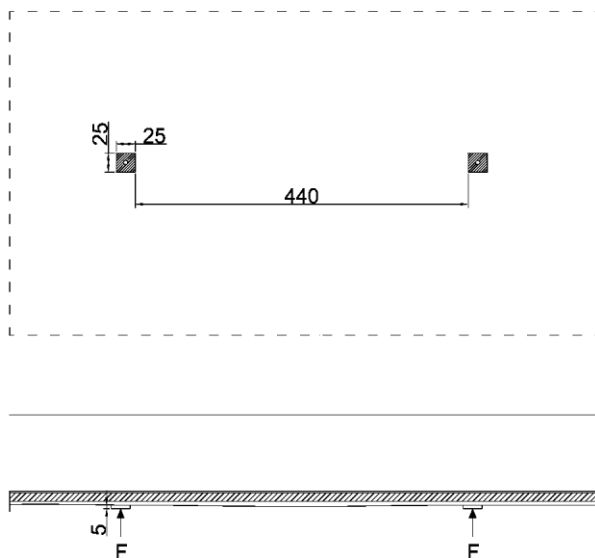

Figure I.1: Resistance to horizontal load test (dimensions in mm).

ANNEX J – BOND STRENGTH TEST

J.1 General

Tests shall be carried out for the connections and conditionings given in table J.1.

Bond strength	Specimen conditioning (i)	Bond strength minimum level (MPa)
		Continuous rendering as exterior skin
Between the whole rendering system and the board	a) dry conditions	≥ 0,08 (iii) or ≥ 0,03 if cohesive rupture in the board
	b) after hygrothermal cycles (ii)	≥ 0,06 (iv) or ≥ 0,03 if cohesive rupture in the board
	c) after freeze-thaw cycles	test for selecting the worst case to be tested to hygrothermal and freeze-thaw cycles (see section L.1.2 of Annex L)
	d) 2 d. H ₂ O + 2 h. drying	
	c) 2 d. H ₂ O + 7 d. drying	
	f) 7 d. H ₂ O + 7 d. drying for finishing coats not tested to hygrothermal cycles	≥ 0,08 (iii) or ≥ 0,03 if cohesive rupture in the board
Between the reinforced base-coat and the board	a) dry conditions	≥ 0,08 (iii) or ≥ 0,03 if cohesive rupture in the board
	d) after hygrothermal cycles (ii)	≥ 0,06 (iv) or ≥ 0,03 if cohesive rupture in the board
	b) 2 d. H ₂ O + 2 h. drying	test for selecting the worst case to be tested to hygrothermal and freeze-thaw cycles (see section L.1.2 of Annex L)
	c) 2 d. H ₂ O + 7 d. drying	
(i) The different conditionings are defined as: a) after at least 28 days curing at (23 ± 2) °C and (50 ± 5) %RH, i.e. without any supplementary conditioning (on dry conditions); b) on samples taken from the specimen after hygrothermal cycles (see section L.1 of Annex L) or after the alternative test combining hygrothermal and freeze-thaw cycles (see section L.3 of Annex L); c) on specimens after freeze-thaw cycles (see section L.2 of Annex L); d) after immersion in water for 2 days and 2 hours drying at (23 ± 2) °C and (50 ± 5) %RH after removing the samples from the water; e) after immersion in water for 2 days and 7 days drying at (23 ± 2) °C and (50 ± 5) %RH after removing the samples from the water; f) after immersion in water for 7 days and 7 days drying at (23 ± 2) °C and (50 ± 5) %RH after removing the samples from the water. (ii) On samples taken from the specimen. (iii) The minimum value of the test results shall be greater or equal than this value with adhesive rupture. One single test result lower than 0,08 MPa but higher than 0,06 MPa is admissible. (iv) The mean value of the test results shall be greater or equal than this value with cohesive or adhesive rupture.		

Table J.1: Bond strength. Conditioning and minimum level.

J.2 Preparation of the test specimen

Samples with appropriate size to obtain the cut specimens shall be prepared according to the manufacturer instructions. Components used, thickness, weight and method of application shall be recorded.

Samples are cured at least 28 days at (23 ± 2) °C and (50 ± 5)% RH (conditioning given as a) in table J.1).

Test shall be carried out on at least five specimens, for each connection and conditioning, obtained by cut on the large sample size.

Each specimen shall have a square surface with dimension 50 mm x 50 mm or a circular surface diameter 50 mm.

The specimens are cut through the layers according to figure J.1 (cutting until the board) using an adequate tool. At least 50 mm of distance is necessary between each specimen and with the border of the sample. Metal plates of appropriate size are affixed to these areas with a suitable adhesive.

J.3 Test procedure

The bond strength test (see figure J.1) is performed until the board at a tensioning speed between 1 to 10 mm/minute.

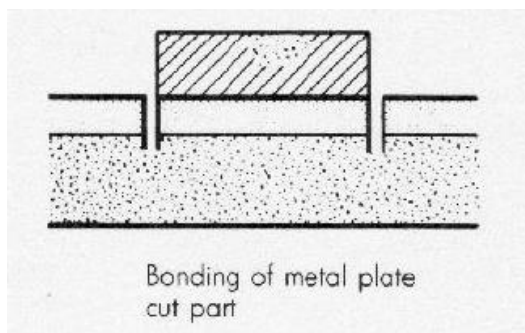

Figure J.1: Bond strength test.

J.4 Test results

Each individual value of bond strength and the rupture type (cohesive rupture and/or adhesive rupture) shall be recorded.

ANNEX K – MECHANICAL RESISTANCE OF THE CONNECTION BETWEEN THE BOARD AND THE BOARD-FIXING

K.1 – EMBEDDING / SHEAR STRENGTH

Test shall be carried out on at least five specimens for each position:

- Corner (see figure K.1.1).
- Border (see figure K.1.2).

Each specimen shall be composed of a board (size at least 100 mm x 100 mm), fixed to the metal profile with only one fixing.

To define the mechanically weakest case the following aspects shall be taken into account:

- The mechanically weakest board (e.g. minimum thickness, minimum bending strength, without rendering system, etc.).
- The mechanically weakest board-fixing (e.g. minimum diameter, minimum material resistance, etc.).
- The mechanically weakest profile (e.g. minimum thickness, minimum material resistance, etc.).
- Without the rendering system.

When testing, the edge distances a_{min} and b_{min} (according to figures K.1.1 to K.1.4) shall be confirm the smallest edge distances intended to be used for the kit board.

The force is applied as show in figures K.1 until failure. The speed rate shall be adjusted to 5 mm/min.

Failure is defined by breaking of the board, the board-fixing or the profile.

Test report should include:

- Type, material and geometry of the specimen components.
- Each individual failure value, F_{iu} (expressed in N), and the mode of failure of the test specimen.
- The mean values, F_m , and the characteristic values, F_C , in accordance with Annex O.

The mechanical properties of the components used for the test is to be known.

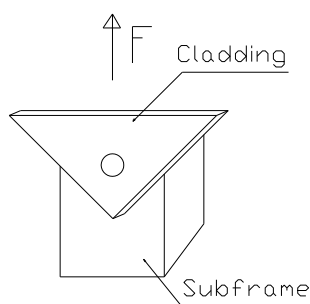

Figure K.1.1: Example of shear strength (corner).

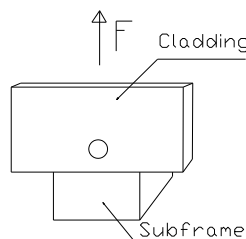
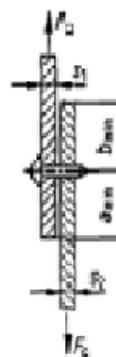

Figure K.1.2: Example of shear strength (border).



F_Q : shear force
 a_{min} : smallest intended edge distance of board
 b_{min} : smallest intended edge distance of the profile
 s_1 : thickness of the board
 s_2 : thickness of the profile

Figure K.1.3: Specimen dimensions.

K.2 - PULL-THROUGH / PULL-OUT RESISTANCE

Test shall be carried out on samples with a board-fixing driven through board position (centre, border and corner) and connected to a profile, or to a test tool representing the same material and thickness of the profile, taking into account the configuration of the kit defined by the manufacturer.

It is recommended to carry out test series for each position (centre, border and corner) or, at least, for the mechanically weakest sample (e.g. minimum thickness of the board, minimum diameter of board-fixing, corner or border position, minimum distances to the borders, etc.).

The board-fixing shall be installed on the board as specified by the manufacturer.

The test series shall be carried out separately on one ring 50 mm diameter for each position.

For each series, at least 5 test specimens shall be carried out.

An axial tension load is exerted on the fixing. The speed rate shall be adjusted to 5 mm/min. The force can be applied either by pushing on the head of the anchor or pulling the end of the fixing.

The force is applied as show in figures K.2.1 and K.2.2 until failure by pulling through.

Test report should include:

- Type, material and geometry of the board-fixing.
- Each individual failure value, F_{iu} (expressed in N), and the mode of failure of the test specimen (pull-out of the anchor, cone failure, etc.).
- The mean values, F_m , and the characteristic values, F_c , in accordance with Annex O.

The mechanical properties of the components used for the test is to be known.

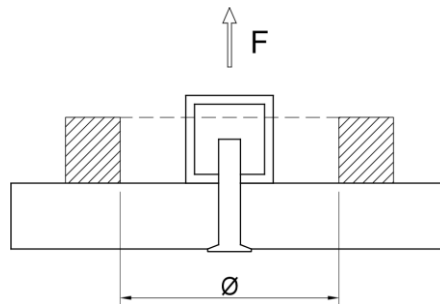

Figure K.2.1: Example of pull-through test in corner.

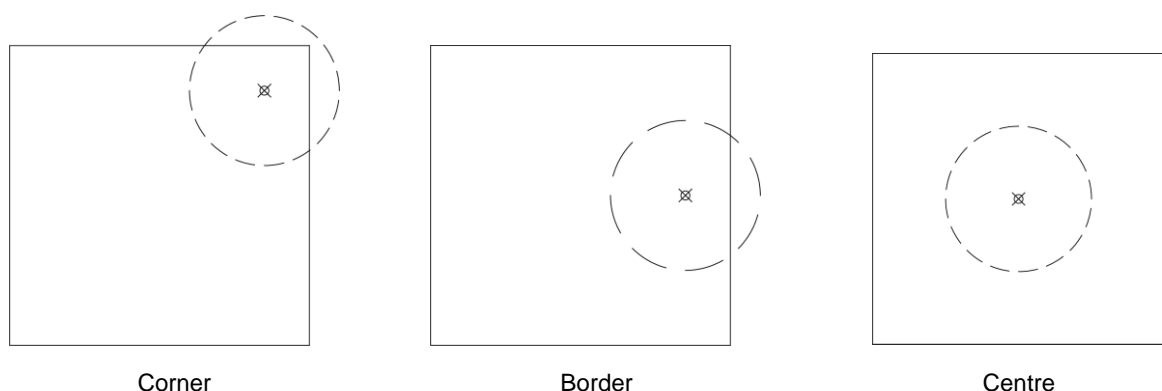

Figure K.2.2: Example of pull-through test, screw in corner, border and centre.

ANNEX L – DURABILITY

This annex establishes the following durability test:

- Two types of accelerated ageing tests, which are:
 1. Hygrothermal behaviour test (see section L.1), which include:
 - Heat-rain cycles
 - Heat-cold cycles
 2. Freeze-thaw behaviour test (see section L.2).

Alternatively, when the manufacturer requires it, a combined hygrothermal and freeze-thaw cycles test may be carried out according to section L.3.

The principle is to determine the effects of accelerated ageing procedures on the kit.

After the accelerated ageing procedures, bond strength tests (see section 2.2.18.1) shall be carried out on samples taken of the test specimens.

The initial test specimens (without accelerated ageing procedures) shall be prepared at the same time that these test samples.

- Cracking strength due to board deformation (see section L.4)

L.1 - HYGROTHERMAL BEHAVIOUR TEST

L.1.1 Principles related to the preparation of the specimen

The kit must be installed, in accordance with the manufacturer's instructions, onto a sufficiently stabilised masonry or concrete substrate (minimum 28 days).

The test wall shall have one or two openings (depending on the number of rendering system configurations that are to be tested) positioned as given in the figures L.1.1. The dimension of the weather surface of the test wall shall be:

- width: $\geq 2,50$ m (for one opening) or $\geq 3,00$ m (for two openings)
- height $\geq 2,00$ m

The openings shall be at the upper part of the test wall positioned at a distance $\geq 0,40$ m from the edges (preferably positioned as shown in figures L.1.1, for one and two openings). The openings shall have a width and a height of $(0,5 \pm 0,1)$ m.

The configuration of the specimen shall be decided according to the following rules:

- At least the worst case (e.g. maximum water absorption of the rendering systems, minimum bond strength, minimum thickness of the rendering system components, etc) or the most representative case of the kit shall be tested. Additional tests given in section L.1.2 may also be taken into account to select the worst case.
- As general rule, for each opening, only one board and only one reinforced base-coat shall be used for the specimen.
- At the very most two rendering systems (different nature of finishing) can be applied per opening in the test wall (vertical divisions). Maximum two configurations in the case one opening (see figure L.1.1a) and maximum four configurations in the case of two openings (see figure L.1.1b).

- If different finishing coats are used, the lower part of the test piece ($A = 1/3$ of the total height) consists of the reinforced base-coat alone (without any finishing coat).

Any finishing coat not tested on the specimen shall be assessed by means of bond strength tests according to section 2.2.18.1 after immersion in water for 7 days and 7 days drying at $(23 \pm 2) ^\circ\text{C}$ and $(50 \pm 5) \%RH$ after removing the samples from the water.

Special methods for reinforcing corners of the opening are applied, if necessary.

Installation of the window sill and other ancillary materials is under responsibility of the manufacturer.

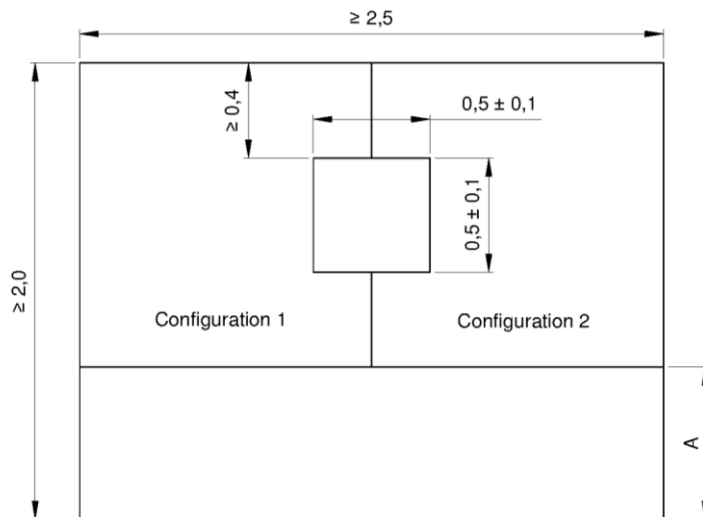

Figure L.1.1a: Example of hygrothermal behaviour test specimen with one opening (dimensions in metres).

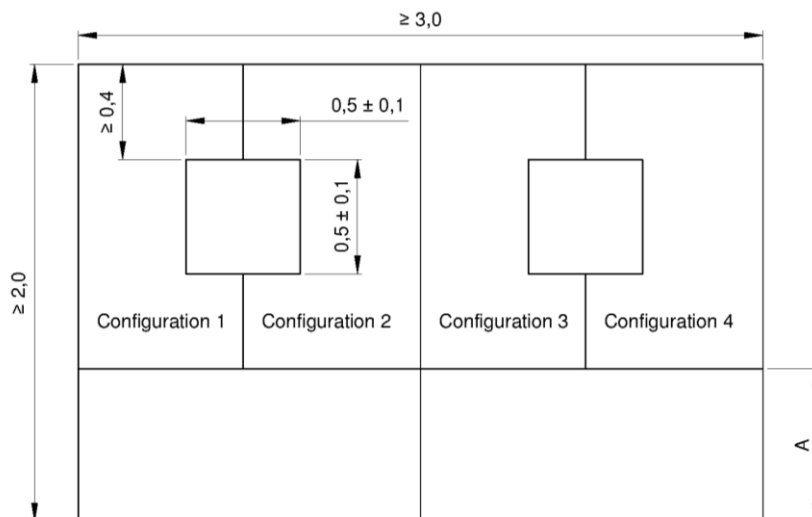

Figure L.1.1b: Example of hygrothermal behaviour test specimen with two openings (dimensions in metres).

L.1.2 Tests for selecting the worst case

When the assessment covers a range of different finishing coats, it is possible to select the worst case to be included in the hygrothermal cycle test rig by means of bond strength tests according to section 2.2.18.1 after:

- immersion in water for 2 days and 2 hours drying at $(23 \pm 2) ^\circ\text{C}$ and $(50 \pm 5) \%RH$ after removing the samples from the water;

- immersion in water for 2 days and 7 days drying at (23 ± 2) °C and (50 ± 5) %RH after removing the samples from the water;

Bond strength lower values should be considered as worst case.

L.1.3 Preparation of the specimen

The preparation of the specimen shall be carried out by the manufacturer and be supervised by the laboratory in charge of the test, regarding:

- Checking of the respective manufacturer prescriptions: all stages shall be in accordance with the technical documentation of the manufacturer.
- Registering of all the stages of the installation:
 - the date and time of the various stages,
 - temperature and % RH during the installation (every day – at least at the beginning),
 - name and production lot of the components,
 - figure describing the specimen (place of the kit components and of the joints, ...),
 - way of base-coat and finishing coat preparation (tool, % of mixing, possible pause time before application, etc.) as well as their way of application (hand tool, machines, number of layers, etc.),
 - quantities and/or thickness of base-coat and finishing coat applied per square meter,
 - drying period between each layer,
 - use and position of accessories,
 - any other relevant information.

Quantities and/or thicknesses applied shall be recorded as well as characterization of the rendering system components.

L.1.4 Conditioning of the specimen

Each layer shall be cured internal for the time defined by the manufacturer (if no information is given, the whole specimen shall be cured for 28 days). During the curing time the ambient temperature shall be (20 ± 10) °C. The relative humidity shall not be less than 50%. To ensure that these conditions are met, records shall be made at regular intervals.

To prevent the layers from drying out too rapidly the manufacturer may require the layers to be wetted once per week by spraying for approximately 5 minutes. This should start according to the prescriptions of the manufacturer.

During the curing time any deformations of the layers, i.e. blistering, cracking, are recorded.

L.1.5 Hygrothermal cycles

The test apparatus is positioned against the front face of the specimen, 0,10 m to 0,30 m from the edges.

The specified temperatures during the cycles are measured at the surface of the specimen. The regulation shall be obtained by adjustment of the air temperature.

Heat - rain cycles

The specimen is subjected to a series of 80 cycles, comprising the following phases:

1. Heating to 70°C (rise for 1 hour) and maintaining at $(70 + 5)$ °C and 10% to 30% RH for 2 hours (total of 3 hours).
2. Spraying for 1 hour, water temperature (15 ± 5) °C, amount of water $(1,5 \pm 0,5)$ l/m² min.

3. Leave for 2 hours (drainage) at (20 ± 5) °C.

Heat-cold cycles

After at least 48 hours of subsequent conditioning at temperatures (20 ± 10) °C and a minimum relative humidity of 50%, the same test specimen is exposed to 5 heat/cold cycles of 24 hours comprising the following phases:

1. Exposure to (50 ± 5) °C (rise for 1 hour) and maximum 30% RH for 7 hours (total of 8 hours).
2. Exposure to $(- 20 \pm 5)$ °C (fall for 2 hours) for 14 hours (total of 16 hours).

L.1.6 Observations during the tests

At periods of every four cycles during the heat/rain cycles and at every cycle during the heat/cold cycles, observations relating to a change in characteristics or performance (blistering, detachment, crazing, loss of adhesion, formation of cracks, etc.) of the whole rendering system and of the part of the specimen consisting of only the reinforced base-coat are recorded as follows:

- the surface finish (base-coat or whole rendering system) of the kit must be examined to establish whether any cracking has occurred. The dimensions and position of any cracks should be measured and recorded,
- the surface should also be checked for any blistering or peeling, and the location and extent should again be recorded,
- the sills and profiles should be checked for any damage/degradation together with any associated cracking of the finish. Again, the location and extent should be recorded.

Following the completion of the test, a further investigation is conducted involving removal of sections containing cracks to observe any water penetration within the kit (e.g. back of the board).

L.1.7 After the cycles

After the heat-rain and heat-cold cycles, bond strength tests (see section 2.2.18.1) shall be carried out on samples taken from the test specimens.

These tests shall be performed after at least 7 days drying.

L.1.8 Test report

The test report shall detail the following:

- Observations recorded during the test (see section L.1.6).
- Photos to detail the damages occurred on each specimen after the cycles and, if necessary, after each visual inspection.

L.2 FREEZE-THAW BEHAVIOUR TEST

The freeze-thaw test shall be carried out as determined by the analysis of the capillarity test (see section 2.2.6.1), i.e. shall be carried out except when the water absorption after 24 hours of both, the reinforced base-coat (without finishing coat) and the whole rendering system (with finishing coat) determined for each type of finishing coat is less than 0,5 kg/m².

L.2.1 Test specimen preparation

The test shall be carried out on at least three samples 500 mm x 500 mm.

These samples are prepared according to the manufacturer's instructions and then stored for at least 28 days at (23 ± 2) °C and (50 ± 5) % RH.

The test specimens shall be prepared with the board as substrate. At least three specimens shall be tested for each case.

Each test specimen must be made of:

- Substrate made of two board pieces connected by an intermediate joint (with the respective joint treatment), see figure L.2.1 minimum area for each board piece should be 900 cm² (e.g. 300 x 300 mm or 200 x 500 mm).
- Each rendering system to be assessed.

The edges of the specimens (including the board) should be sealed against water.

Quantities and/or thicknesses applied shall be recorded as well as characterization of the board and rendering system components.

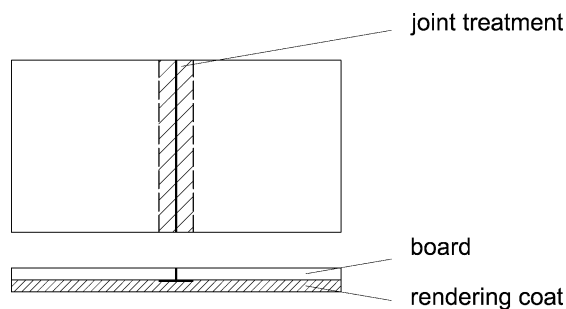

Figure L.2.1: Example of freeze-thaw behaviour test specimen

L.2.2 Freeze-thaw cycles

The specimens are subjected to a series of 30 cycles comprising:

1. Exposure to water for 8 hours at (23 ± 4) °C by immersion of the specimens, with the rendering system submerged in a water bath, according to the method described in section 2.2.6.1.
2. Freezing to (-20 ± 2) °C (fall for 2 hours) for 14 hours (total of 16 hours).

If the test is interrupted, because the specimens are handled manually and there are stops during weekends or holidays the specimens shall always be stored at a temperature of (-20 ± 2) °C between the cycles.

Remark: the specified temperatures are measured at the surface of the samples. The regulation is obtained by conditioned air.

L.2.3 Observations

At the end of the test, observations relating to a change in characteristics of the surface or to the behaviour of the kit are recorded according to section L.1.6.

Any distortion at the edges of the samples shall also be reported.

L.2.4 After the cycles

After the freeze-thaw cycles, bond strength tests (see section 2.2.18.1) shall be carried out on each specimen submitted to freeze-thaw cycles.

These tests shall be performed after at least 7 days drying.

L.2.5 Test report

See section L.1.8.

L.3 ALTERNATIVE TEST WITH COMBINED HYGROTHERMAL AND FREEZE-THAW CYCLES

L.3.1 Principles related to the preparation of the samples

See section L.1.1.

L.3.2 Preparation of the specimen

See section L.1.2 and L.1.3.

L.3.3 Conditioning of the specimen

See section L.1.4.

L.3.4 Hygrothermal cycles

The test apparatus is positioned against the front face of the specimen, 0,10 m to 0,30 m from the edges.

The specified temperatures during the cycles are measured at the surface of the specimen. The regulation shall be obtained by adjustment of the air temperature.

Heat - rain cycles:

The specimen is subjected to a series of 80 cycles (6 hours each cycle), comprising the following phases:

1. Heating to 70°C (rise for 1 hour) and maintaining at (70 ± 5) °C and 10% to 30% RH for 2 hours (total of 3 hours).
2. Spraying for 1 hour, water temperature (15 ± 5) °C, amount of water $(1,5 \pm 0,5)$ l/m² min.
3. Leave for 2 hours (drainage) at (20 ± 5) °C.

Heat-cold cycles:

After at least 48 hours of subsequent conditioning at temperature (20 ± 10) °C and a minimum relative humidity of 50%, the same test specimen is exposed to 5 heat/cold cycles of 24 hours comprising the following phases:

1. Exposure to (50 ± 5) °C (rise for 1 hour) and maximum 30% RH for 7 hours (total of 8 hours).
2. Exposure to (-20 ± 5) °C (fall for 2 hours) for 14 hours (total of 16 hours).

Freeze-thaw cycles:

After at least 48 hours of subsequent conditioning at temperature (20 ± 10) °C and a minimum relative humidity of 50%, the same test specimen is exposed to:

- Conditioning the test specimen spraying for 8 hours, water temperature (15 ± 5) °C, amount of water $(1,5 \pm 0,5)$ l/m²-min.
- 30 freeze/thaw cycles of 8 hours comprising the following phases:
- Freeze the surface of the specimen at least 2 hours to (-20 ± 5) °C and maintain it for 4 hours (in total 6 hours).
- Thaw the specimen for 1 hour at temperature of (20 ± 5) °C.
- Spraying for 8 hours, water temperature (15 ± 5) °C, amount of water $(1,5 \pm 0,5)$ l/m²-min.

After the 30 cycles condition specimen at ambient temperature (20 ± 10) °C.

L.3.5 Observations during the tests

At periods of every four cycles during the heat/rain cycles and at every cycle during the heat/cold cycles and freeze-thaw cycles, observations relating to a change in characteristics or performance (blistering, detachment, crazing, loss of adhesion, formation of cracks, etc.) of the whole rendering system and of the part of the specimen consisting of only the reinforced base-coat are recorded as follows:

- the surface finish (base-coat or whole rendering system) of the kit must be examined to establish whether any cracking has occurred. The dimensions and position of any cracks should be measured and recorded,
- the surface should also be checked for any blistering or peeling, and the location and extent should again be recorded,
- the sills and profiles should be checked for any damage/degradation together with any associated cracking of the finish. Again, the location and extent should be recorded.

Following the completion of the test, a further investigation is conducted involving removal of sections containing cracks to observe any water penetration within the kit (e.g. back of the board).

L.3.6 After the cycles

See section L.1.7.

L.3.7 Test report

See section L.1.8.

L.4 - CRACKING DUE TO SUBSTRATE DEFORMATION

This section establishes the procedure to carry out the substrate deformation cycles to assess the behaviour of the rendering system due to these deformations.

After the substrate movement cycles procedure water absorption by capillarity test is necessary (see sections 2.2.6.1).

L.4.1 Test specimen conditioning

The tests specimens shall be conditioned for 28 days in normal laboratory conditions corresponding to (20 ± 10) °C and (50 ± 20) % relative humidity.

L.4.2 Test specimen preparation

At least 4 test specimens are necessary (after the cycles, one of these test specimens will be used for the water permeability test and the other three test specimens will be used for the water absorption test).

The test specimen shall consist of a substrate (board) and the rendering system (base-coat and finishing coat) applied over the substrate.

The substrate dimensions and the span length shall be chosen taking into account the following rules:

- a) The ratio span length / nominal thickness shall be equal or higher than 15.
- b) The test specimen wide shall be equal or higher than five times their nominal thickness.

An example of the dimensions for the test specimen can be 900 mm long by 300 mm wide with a span length of 600 mm.

The rendering system must be applied with the worst or the most representative thickness (e.g. minimum thickness) applied according to the manufacturer's instructions.

L.4.3 Test procedure

After conditioning, the test specimen is placed on a support at either end such that there is a minimum clear span of the distance between vertical profiles.

A cyclical downward vertical distributed force (load and unload) is applied to the test specimen at the mid-span as shown in figure L.4.1.

The cyclical force is applied during 100 cycles.

The force to be applied must be $F = 0,25 \cdot F_{\max}$ where F_{\max} is the maximum load reached in the bending strength test (see section 2.2.18.2).

After the substrate movement cycles procedure water absorption by capillarity test is necessary (see sections 2.2.6.1).

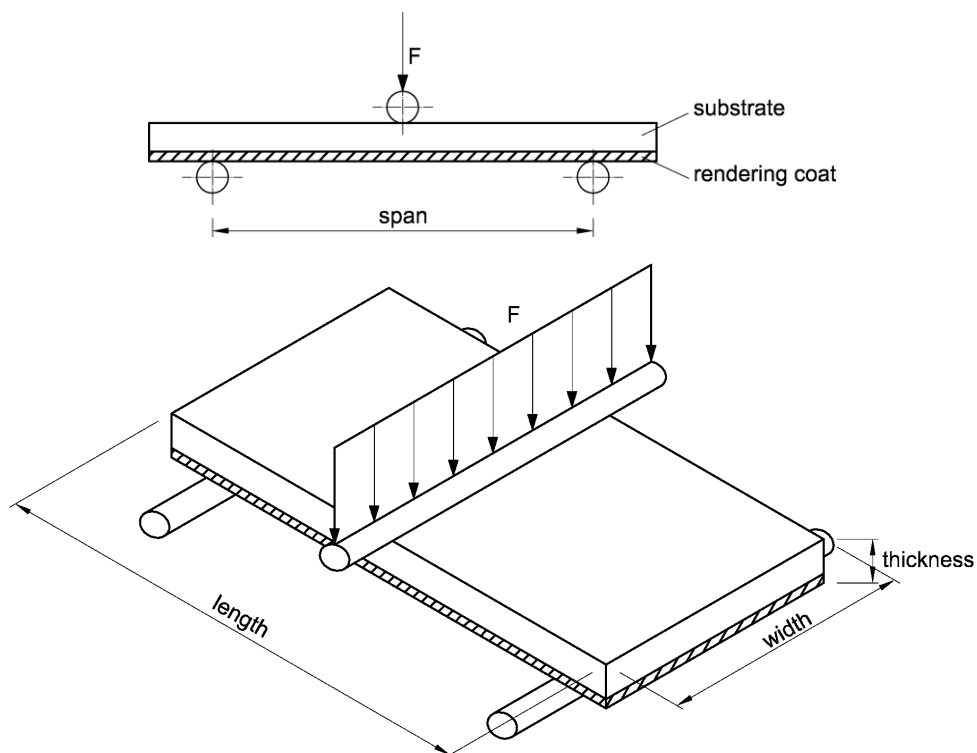

Figure L.4.1: Example of test specimen.

L.4.4 Test results

The condition of the rendering system on the deflected board shall be inspected immediately after the test. Any cracking, spalling, adhesive or cohesive failure shall be recorded.

The dimensions of the test specimen, the applied load, the span length, the number of cycles and the frequency shall be given.

ANNEX M – SEQUENCE FOR WEATHER RESISTANCE TESTS

The tests for weather resistance are the following tests:

- Watertightness (see section 2.2.4).
- Air permeability (see section 2.2.9).
- Wind load resistance (see section 2.2.11).

These tests may depend on each other, therefore when at least two of these test are carried out, it is necessary to carry out a combined test following the test sequence indicated bellow:

- 1) Air permeability for classification.
- 2) Watertightness under static load (EN 12155) or dynamic load (EN 12865) for classification.
- 3) Wind load resistance. Test with characteristic load.
- 4) Air permeability to confirm the wind load resistance.
- 5) Watertightness under static load (EN 12155) or dynamic load (EN 12865) to confirm the wind load resistance.
- 6) Wind load resistance. Test with incremented load.

ANNEX N – ALTERNATIVE WATER PENETRATION TESTS

N.1 Test procedure

Water penetration tests should be conducted on a test sample that incorporates an opening detail (e.g. as indicated in the section L.1 of Annex L) and has been installed onto a frame according to the test equipment. The sample should incorporate joints (horizontal and/or vertical) representing the assembled kit.

The simulated driven rain test should be conducted in accordance with EN 12865 (Procedure A). The pressure difference witnessed during the test should be compared to table N.1 below and assessed in accordance with table N.2. No water penetration should be witnessed during the test.

Pressure range (Pa)	Equivalent exposure zone ⁷
> 931 - < 1032	Sheltered
>1032 - < 1249	Moderate
> 1249 - < 1365	Severe

Table N.1: Equivalent exposure zone.

N.2 Provisions for limit values and classes

The provisions for limit values and classes relevant for water penetration of the assembled kits shall be assessed according to table N.2. Overall rating = $D_{r\ test} \times D_f \times I_f \times M_f$ (see section N.3).

Overall rating	Intended use
> 0 to ≤ 10	For use in the situation that the test method indicates OK.
> 10 to ≤ 20	For use in the exposure zone indicated by the test method with increased maintenance and inspection.
> 20 to ≤ 40	For use in less exposed zones than those indicated by the test method with increased maintenance and inspection ⁸ .
> 40 to ≤ 100	For use in sheltered zones with increased maintenance and inspection.
> 100	For use in internal or non-exposure zones.

Table N.2: Use in a particular exposure zone.

N.3 Analysis of simulated driven rain test results

In order to address the queries concerning non load-bearing external wall systems a weighted method similar to a Failure Mode and Effects Criticality Assessment (FMECA) approach has been developed. This relates each tested assembled kit to the use in a particular exposure zone.

The results of the driven rain test should be considered with relation to table N.3 below. A factor to the measures against water ingress should be taken from table N.4. A factor concerning the level of site supervision should be taken from table N.6, and a factor concerning the likelihood of the installed assembled kit being regularly maintained from table N.7.

Each of the factors should be combined using the following method to give an overall rating for the assembled kit which can be used to give preliminary guidance concerning the use of an assembled kit in a particular exposure zone.

$$\text{Overall rating} = D_{r\ test} \times D_f \times I_f \times M_f$$

⁷ Note the assembled kits should not be considered for use in zones that have more than severe exposure, i.e. very severe.

⁸ For example, this rating could result in a change from Severe to Moderate exposure zones.

N.3.1. Test result grading⁹

Test Result	Driven rain grade ($D_{r \text{ test}}$)
For use in sheltered areas.	1
For use in moderated areas.	2
For use in severe areas.	4

Table N.3: Driven rain grade factor $D_{r \text{ test}}$.**N.3.2. Test weighting assigned to the specific details of a assembled kit**

Detail	Detail factor (D_f)
Cavity, breather membrane, water management system ensuring any water ingress is directed outwards.	2
Breather membrane.	5
No second line of defence against water ingress.	10

Table N.4: Detail factor D_f .**N.3.3. Installation factor**

An on-site installation check list should cover the points indicated in table N.5.

Installation stage	Check point
Overall construction	Are the manufacturer's instructions available?
	Have the correct materials been specified?
Stage 1 Preliminary work	Has the appropriate preliminary work been carried out as detailed by the manufacturer's instructions?.
Stage 2 Installation of the subframes and external layers.	<p>Have these components been installed as detailed in the manufacturer's instructions?. For example, have the following been completed as detailed in the manufacturer's instructions:</p> <ul style="list-style-type: none"> - General layout of the subframes and the thermal insulation products. - General layout of external layer (boards, joint treatments and the optional waterproofing layer). - Layout of external layer around openings and penetrations. - General condition of any drainage cavity formed within the assembled kit. - Fixings.
Stage 3 Application of rendering system	<p>Are the appropriate materials and seals being used as detailed in the manufacturer's instructions? For example, have the following been completed as detailed in the manufacturer's instructions:</p> <ul style="list-style-type: none"> - Application of seals around openings. - Beading (type and layout). - Detailing around openings and penetrations.

Table N.5: Installation check list.

Checklist followed	Installation factor (I_i)
Yes	1
No	10

Table N.6: Installation factor I_i .

⁹ For example this rating could result in a change from Severe to Moderate exposure zones.

N.4.4. Maintenance factor

This assessment method is based upon the assumption that appropriate regular maintenance is carried out and that any problems associated with water ingress are readily identifiable and corrected as soon as they are noted.

Appropriate maintenance relates to yearly inspections and makes the assumption that repairs are conducted as soon as a problem is noted. In severe locations increased levels of maintenance may be required. This would typically require 2 or more inspection visits per year and should include an assessment of moisture levels within the structure. As noted previously it is expected of this type rely on sealants for weatherproofing, the sealant should be inspected and replaced at regular intervals to ensure it remains effective.

The increased inspection visits may offset the risk of water penetration by highlighting problems before they cause substantial damage to the construction. Techniques such as thermography (The use of an IR sensitive camera to detect temperature differentiation associated with damp areas) could be used to expose the presence of water within a construction.

Maintenance possible	Maintenance factor (M_f)
Yes	1
No	100

Table N.7: Maintenance factor M_f .

N.5 Assessment

Each of the factors should be combined using the following method to give an overall rating for the assembled kit which can be used to give preliminary guidance concerning the use of the assembled kit in a particular exposure zone.

The overall rating should be compared to the values listed in table N.2.

Worked examples can be seen below.

Description	$D_{r \text{ test}}$	D_f	I_f	M_f	Overall rating	Use category
Non load-bearing external wall systems with rendering and waterproofing layer. The assembled kit has been tested for use in sheltered conditions and there is no intention to monitor the installation of the assembled kit on-site.	1	5	10	1	50	Sheltered with increased maintenance and inspection.
Non load-bearing external wall systems with rendering and waterproofing layer. The assembled kit has been tested for use in exposed conditions and the installation on-site is to be carried out in accordance with the manufacturer's recommendations.	4	5	1	1	20	Severe with increased maintenance and inspection.
Non load-bearing external wall systems with rendering without waterproofing layer. The assembled kit has been tested for use in moderated conditions and the installation on-site is to be carried out in accordance with the manufacturer's recommendations	2	10	1	1	20	Moderate with increased maintenance and inspection.

Table N.8: Examples.

ANNEX O – TEST RESULTS STATISTICAL DESCRIPTION

$$F_{u,5} = F_{\text{mean}} - k_n \cdot S$$

Where:

$F_{u,5}$ = the characteristic breaking force giving 75 % confidence that 95 % of the test results will be higher than this value

F_{mean} = the mean breaking force, either under tension or shear

k_n = the variable as a function of the number of test specimens for 5 % ($p = 0,95$) with 75 % confidence level when the population standard deviation is unknown (see table N.1)

S = the standard deviation of series under consideration

Table O.1 – The variable k_n as a function of the number of test specimens (see EN 1990 Eurocode: *Basis of structural design*, table D1, V_x , unknown).

Number of specimens	3	4	5	6	7	8	10	20	30	∞
Variable k_n	3,37	2,63	2,33	2,18	2,10	2,00	1,92	1,76	1,73	1,64

