

---

European Organisation for Technical Approvals  
Europäische Organisation für Technische Zulassungen  
Organisation Européenne pour l'Agrément Technique

---

**ETAG n° 21**  
**Edition September 2005**

GUIDELINE FOR EUROPEAN TECHNICAL APPROVAL

OF

**COLD STORAGE PREMISES KITS**  
**Part 1: COLD STORAGE ROOM KITS**  
**(Annexes)**

EOTA  
Kunstlaan 40, avenue des Arts B-1040 Brussels

## TABLE OF CONTENTS

<a href="#">Annex A Common Terminology and Abbreviations</a>	3
<a href="#">Annex B Specific terminology and abbreviations related to the products and their intended use covered by this Guideline</a>	6
<a href="#">Annex C List of Reference Documents</a>	16
<a href="#">Annex D Test methods for determining the racking resistance</a>	20
<a href="#">Annex E Test methods for determining the resistance to axial loads</a>	27
<a href="#">Annex F Determination of Floor Slipperiness</a>	31
<a href="#">Annex G Determination of displacement volume</a>	36
<a href="#">Annex H Determination of the susceptibility to the growth of harmful micro-organisms</a>	38
<a href="#">Annex I Determination of resistance to rolling load</a>	40
<a href="#">Annex J Recommended checklist for Initial Inspection of Factory and of Factory Production Control and for the continuous surveillance of Factory Production Control</a>	50
<a href="#">Annex K Extended Application of results from fire resistance tests for cold storage room walls (made out of composite panels)</a>	53
<a href="#">Annex L Example of a European Technical Approval (ETA)</a>	65
<a href="#">Annex M Example CE Certificate</a>	89
<a href="#">Annex N Example EC Declaration of conformity</a>	91

## ANNEX A COMMON TERMINOLOGY AND ABBREVIATIONS

### **Works and products**

**Construction works (and parts of works)** (often simply referred to as “works”) (ID1.3.1)

Everything that is constructed or results from construction operations and is fixed to the ground. (This covers building and civil engineering works, and structural and non-structural elements).

**Construction products** (often simply referred to as “products”) (ID 1.3.2)

Products which are produced for incorporation in a permanent manner in the works and placed as such on the market.

(The term includes materials, elements, components and prefabricated systems or installations.)

**Incorporation** (of products in works) (ID 1.3.1)

Incorporation of a product in a permanent manner in the works means that:

- its removal reduces the performance capabilities of the works, and
- that the dismantling or the replacement of the product are operations which involve construction activities.

**Intended use** (ID 1.3.4)

Role(s) that the product is intended to play in the fulfilment of the essential requirements.

**Execution** (ETAG-format)

Used in this document to cover all types of incorporation techniques such as installation, assembling, incorporation etc.

**System** (EOTA/TB guidance)

Part of the works realised by

- particular combination of a set of defined products, and
- particular design methods for the system, and/or
- particular execution procedures.

**Fitness for intended use** (of products) (CPD 2.1)

Means that the products have such characteristics that the works in which they are intended to be incorporated, assembled, applied or installed, can, if properly designed and built, satisfy the essential requirements.

**Serviceability** (of works)

Ability of the works to fulfil their intended use and in particular the essential requirements relevant for this use.

The products must be suitable for construction works which (as a whole and in their separate parts) are fit for their intended use, subject to normal maintenance, be satisfied for an economically reasonable working life. The requirements generally concern actions which are foreseeable (CPD Annex I, Preamble).

**Essential requirements (for works)**

Requirements applicable to works, which may influence the technical characteristics of a product, and are

set out in objectives in the CPD, Annex I (CPD, art. 3.1).

**Performance** (of works, parts of works or products) (ID 1.3.7)

The quantitative expression (value, grade, class or level) of the behaviour of the works, parts of works or of the products, for an action to which it is subject or which it generates under the intended service conditions (works or parts of works) or intended use conditions (products).

**Actions** (on works or parts of the works) (ID 1.3.6)

Service conditions of the works which may affect the compliance of the works with the essential requirements of the Directive and which are brought about by agents (mechanical, chemical, biological, thermal or electro-mechanical) acting on the works or parts of the works.

**Classes or levels (for essential requirements and for related product performances)** (ID 1.2.1)

A classification of product performance(s) expressed as a range of requirement levels of the works, determined in the ID's or according to the procedure provided for in art. 20.2a of the CPD.

**ETAG-format**

**Requirements** (for works) (ETAG-format 4)

Expression and application, in more detail and in terms applicable to the scope of the guideline, of the relevant requirements of the CPD (given concrete form in the ID's and further specified in the mandate, for works or parts of the works, taking into account the durability and serviceability of the works.

**Methods of verification** (for products) (ETAG-format 5)

Verification methods used to determine the performance of the products in relation to the requirements for the works (calculations, tests, engineering knowledge, evaluation of site experience, etc.)

**Specifications** (for products) (ETAG-format 6)

Transposition of the requirements into precise and measurable (as far as possible and proportional to the importance of the risk) or qualitative terms, related to the products and their intended use.

**Working life**

**Working life** (of works or parts of the works) (ID 1.3.5(1))

The period of time during which the performance will be maintained at a level compatible with the fulfilment of the essential requirements.

**Working life** (of products)

Period of time during which the performances of the product are maintained - under the corresponding service conditions - at a level compatible with the intended use conditions.

**Economically reasonable working life** (ID 1.3.5(2))

Working life which takes into account all relevant aspects, such as costs of design, construction and use, costs arising from hindrance of use, risks and consequences of failure of the works during its working life and cost of insurance covering these risks, planned partial renewal, costs of inspections, maintenance, care and repair, costs of operation and administration, of disposal and environmental aspects.

**Maintenance** (of works) (ID 1.3.3(1))

A set of preventive and other measures which are applied to the works in order to enable the works to fulfil all its functions during its working life. These measures include cleaning, servicing, repainting, repairing, replacing parts of the works where needed, etc.

**Normal maintenance** (of works) (ID 1.3.3(2))

Maintenance, normally including inspections, which occurs at a time when the cost of the intervention which has to be made is not disproportionate to the value of the part of the work concerned, consequential costs (e.g. exploitation) being taken into account.

**Durability** (of products)

Ability of the product to contribute to the working life of the work by maintaining its performances, under the corresponding service conditions, at a level compatible with the fulfilment of the essential requirements by the works.

**Conformity**

**Attestation of conformity** (of products)

Provisions and procedures as laid down in the CPD and fixed according to the directive, aiming to ensure that, with acceptable probability, the specified performance of the product is achieved by the ongoing production.

**Identification** (of a product)

Product characteristics and methods for their verification, allowing to compare a given product with the one that is described in the technical specification.

**Abbreviations**

**Abbreviations concerning the Construction products directive**

AC:	Attestation of conformity
CEC:	Commission of the European Communities
CEN:	Comité européen de normalisation
CPD:	Construction products directive
EC:	European communities
EFTA:	European free trade association
EN:	European Standards
FPC:	Factory production control
ID:	Interpretative documents of the CPD
ISO:	International standardisation organisation
SCC:	Standing committee for construction of the EC

**Abbreviations concerning approval:**

EOTA:	European organisation for technical approvals
ETA:	European technical approval
ETAG:	European technical approval guideline
TB:	EOTA-Technical board
UEAtc:	Union européenne pour l'agrément technique

**General abbreviations:**

TC:	Technical committee
WG:	Working group

## **ANNEX B**

### **SPECIFIC TERMINOLOGY AND ABBREVIATIONS RELATED TO THE PRODUCTS AND THEIR INTENDED USE COVERED BY THIS GUIDELINE**

#### **B.1 Specific terminology related to the products and their intended use covered by this Guideline**

(readily) Accessible:

Manufactured to be exposed for cleaning and inspection without the use of tools.

Accessible for maintenance:

In the framework of this ETA-Guideline, the accessibility of ceilings depends both on the impact resistance of the panel assembly and on the accessibility characteristics of the ceiling panels. However, access should always be limited to a single person, taking due care. The frequency should be limited to once a month.

Adhesive (glue): In the framework of this ETA-Guideline, an adhesive is a non-metallic substance capable of joining materials by surface bonding (adhesion) and the bond possessing adequate internal strength (cohesion). In particular, adhesives are being used to fasten slab stock (preformed slabs) cores to the faces of composite panels.

Air curtain:

Technical equipment, producing a controlled stream of (cold) air aimed across an opening to create an air seal. This seal separates different environments, while allowing flow of traffic and unobstructed vision through the opening.

Blast freezer:

Technical equipment, intended to be used to freeze products quickly to temperatures below  $-30^{\circ}\text{C}$ , using a system with high-speed forced air directed at the product, to freeze it quickly to the centre, virtually without deterioration.

Bolt head:

The portion of a panic or emergency device which engages with the keeper to secure the door in the closed position.

Building hardware:

Products, used to operate or install doors and windows (locks, hinges, handles, latches, ...)

Characteristic value:

Value of a material or product property having a prescribed probability of not being attained in a hypothetical unlimited test series. This value generally corresponds to a specific fractile of the assumed statistical distribution of the particular property of the material or product. A nominal value is used as the characteristic value in some circumstances. However, often, the characteristic value takes the confidence level into account.

Chill storage room:

Cold storage room, usually intended to be used between a temperature interval between  $-10^{\circ}\text{C}$  and  $+15^{\circ}\text{C}$  (also called "chill store").

Clean room:

Room in which the number concentration of airborne particles is controlled; constructed and used in a manner to minimise the introduction, generation and retention of particles inside the room and in which relevant clean processing parameters (e.g. temperature, humidity and pressure) are controlled as necessary.

(easily) Cleanable:

Manufactured such that food, feed and other soiling material may be removed by manual cleaning methods.

Cold storage building:

Building, in which products can be stored, usually at temperatures below +15 °C and above –40 °C. The external building envelope is exposed to weather influences.

Cold storage room:

Room in which products can be stored, usually at temperatures below +15 °C and above –40 °C. The external room envelope is not exposed to weather influences.

Compartment:

Partitions can be used to create compartments, with or without doors, within one cold storage room. Compartments within one room have the same environmental conditions (temperature, relative humidity, ...).

Composite insulation material:

Material composed of more than one insulation material (MW, EPS, XPS, PUR, PIR, modified PF, CG or others), reinforced or not.

Controlled environment room:

Room in which products can be stored, treated or processed, usually at temperatures above +15 °C. The external room envelope is not exposed to weather influences.

Cool tunnel:

Enclosed space, usually with a conveyer belt, in which products are processed with the temperature of the assembly increasing or decreasing significantly between start and end of the tunnel, usually just above or below 0 °C.

Corrosion resistant:

Capacity to maintain intended surface characteristics under prolonged contact with the intended end use environment and exposure to appropriate cleaning agents and sanitising methods.

(Thermally insulating) Core:

Thermally insulating product positioned between two faces; This ETA-Guideline does not contain the necessary assessment for kits, containing panels, based on composite insulation material. In this ETA-Guideline, the term "core" will be used.

Crevice:

Surface defect (e.g. cracks, fissures) which adversely affects cleanability

Defrost systems

System, usually foreseen on doors and/or pressure relief provisions of cold storage rooms, intended to be used below 0°C, preventing those components from freezing. Generally, these are electric, hot gas or water-based systems.

Design value:

Value obtained by dividing the characteristic value by a partial factor  $\gamma_m$  (for material property) or  $\gamma_M$  (for material property also accounting for model uncertainties and dimensional variation) or, in special circumstances, by direct determination.

Display counter:

Enclosed space, usually with a (large) transparent surface, with as main intended use displaying products.

Door set heating system:

System, preventing doors from freezing to their frames and floor or threshold and thus preventing opening of the doors.

Door kickplate:

Plate, fastened to the lower face of doors, preventing mechanical damage to the doors.

Doors (gates):

Component for temporary closing access ways, for which the main intended use is the safe passage of pedestrians or vehicles. This ETA-Guideline distinguishes the following doors:

- External (cold storage) door: door which separates the internal cold storage enclosure from the external climate.
- Internal (cold storage) door: door which separates one internal cold storage enclosure from another cold storage enclosure, or another space inside the same building.
- Internal door: door which separates one internal cold storage enclosure from another cold storage enclosure.

In the framework of this ETA-Guideline, the following terms are being used:

- Single and double leaf (bi-parting) horizontally sliding doors
- Single leaf vertically sliding doors
- Single and double leaf hinged doors
- Single and double leaf swing (or flip flap) doors
- Reach-in doors (or hatches)
- Rapid roll fabric doors

Doors are usually also made out of composite panels, but not necessarily (e.g. fabric or PE-based).

Note: In this ETA-Guideline, both the terms "doors" and "gates" are used. They have the same meaning in this ETA-Guideline, but in German, the translation leads to distinction between openings to allow pedestrians (doors) and vehicles (gates) passage.

Duct (conduit):

Tube, pipe or channel through which liquid or gas, electric or telephone cables pass.

Emergency device:

A mechanism consisting of a bolt head(s) which engage(s) with a keeper(s) in the surrounding door frame or floor for securing a door when closed. The bolt head(s) can be released by the lever handle or the push pad positioned on the inside face of the door when it is moved in a downward direction

or in the direction of exit.

Enclosure:

General term, used to refer either to rooms or buildings, or both. Externally used or multi-storey rooms are considered to be buildings, as regards their mechanical behaviour.

Enclosure with combined supporting system:

Enclosure, for its stability depending on the mechanical resistance of the enclosure, and a structural framework or suspension system.

Extension:

In the framework of this ETA-Guideline, an extension of an assembled cold storage room kit is the addition of a number of discrete wall, ceiling and sometimes floor panels. It does not cover the addition of another cold storage room kit, creating two separate rooms or one room, in which a wall has become a partition.

Face (Skin or facing):

Covering made of flat, lightly corrugated or corrugated sheet. A face may be a composite as well. The following distinction is being made:

- Corrugated face: Face, which has been corrugated to give it bending strength.
- Embossed, patterned face: Flat, lightly textured face
- Flat face: Facing without any rolled or pressed profile, or raised strengthening rib
- Lightly profiled face: A lightly profiled face contains rolled-in longitudinal profiling (for metal, of up to 3 mm depth). The bending stiffness of the face itself can be ignored relative to the bending stiffness of the panel as a whole. The face may be treated as though flat for the purposes of global structural analysis. However, light profiling may be of significant benefit in enhancing the wrinkling stress of the face.
- Micro-profiled face: A face layer containing a series of small longitudinal profiles made to add texture for architectural reasons. From a structural point of view, a micro-profiled face may be considered to be a special case of a lightly profiled face.



- Profiled face: Face, which has been formed to give it bending strength. The bending stiffness of the face itself cannot be ignored relative to the bending stiffness of the panel as a whole.
- Smooth face: Faces, free of texture, pits, pinholes, cracks, crevices, inclusions, rough edges, and other surface imperfections detectable by visual or tactile inspection.
- Tread plate: Aluminium sheet with a raised pattern, i.e. a geometrical modification of one side of the surface, obtained by submitting it to a final rolling operation, using a specially prepared roll, engraved with an appropriate pattern (two bar, five bar, diamond, barley seed, almond, etc.).

Feed (or feedingstuff):

Any substance or product, including additives, whether processed, partially processed or unprocessed, intended to be used for oral feeding to animals.

Finishing (finishes):

Prefabricated continuous layer of a product in liquid, paste or powder form that, when applied to a surface, forms a film possessing protective, decorative and/or other specific properties. Internal finishes frequently used are e.g. PVC laminates, PVC paint coating and polyester paint, external finishes are plastisol type coatings, PVf<sup>2</sup> and polyester coatings.

Fixing (fastener):

Component, fastening composite panels to the supporting system or other components to the panels or components to each other mechanically, usually made of a (metal) screw, clip, bracket, etc., possibly with a plastic or metal washer, etc.

Fixing (fastening) system:

System, fastening panels to the supporting system or other components to the panels or components to each other. The system usually consists of a fixing or fixing provision and sometimes a plug.

Floor finishing:

Cold storage floor finishes are usually wood-based panels, resilient floor coverings, steel sheet or a combination of these. They can be loose laid, mechanically fixed or adhered to the floor panel. Ceramic tiles are rarely part of a cold storage room kit, but can be installed on site in the assembled kit.

Food (or foodstuff):

Any substance or product, whether processed, partially processed or unprocessed, intended to be, or reasonably expected to be ingested by humans. It includes drink, chewing gum and any substance, including water, intentionally incorporated into the food during its manufacture, preparation or treatment.

Food or feed contact surfaces:

- Packaged food or feed contact surfaces:  
Surfaces intended to come into contact with packaged food or feed
- Unpackaged food or feed contact surfaces:  
Surfaces intended to come into contact with unpackaged food or feed

Food and feed safety:

The assurance that food and feed will not cause adverse health effects to the final consumer when it is prepared and eaten taking into account its intended use.

Free-standing enclosure:

For its stability, the enclosure does not depend on a structural framework, other than the components of the enclosure itself.

Freezer room:

Cold storage room, usually intended to be used between a temperature interval below –10 °C.

Gasket:

Flexible material or product, in a preformed state, that when applied to a joint, seals it by adhering

to one of the surfaces, enabling the joint to prevent or limit the passage of dust, moisture and/or gasses.

Gate:  
See "doors".

Gelcoat:  
Thin layer of unreinforced resin on the outer surface of a reinforced resin moulding, hiding the fibre pattern of the reinforcement.

Gloss:  
The property of a surface related to its ability to reflect light

Hanging rails:  
Provision, facilitating storage of products, by hanging them on horizontal bars or rails.

Joint:  
Construction formed by the adjacent parts of two or more products, components or building elements.

Keeper:  
A socket or other fitting with which the bolt head(s) engages.

Lamella:  
Core material, consisting of mineral wool fibres oriented perpendicularly to the facings prior to bonding.

Lever handle:  
A rotatable operating element whose axis of rotation is perpendicular to the face of the door and which operates the emergency device mechanism in order to release the bolt head(s).

Loads:  
The following loads onto the composite panels can be envisaged (apart from accidental loads, like impacts, which are being considered separately):

- Ceiling/roof panels: Permanent actions (self-weight, permanent imposed temperatures related deformations and technical equipment (permanently present)), variable actions (wind, due to internal under-pressure and irregular pedestrian traffic) and creep (long term effect).
- Wall panels: Permanent actions (self-weight, permanent imposed temperatures related deformations and technical equipment (permanently present) and variable actions (wind, due to internal under-pressure)
- Floor panels (if any): Permanent actions (self-weight, permanent imposed temperatures related deformations and technical equipment (permanently present)) and variable actions (regular pedestrian (and vehicle) traffic and stored products)

Load-bearing composite panels:  
Composite panels, not intended to be supported. Loads (e.g. self-weight, pedestrian traffic, technical equipment, etc.) are being transferred in their plane to other (structural) elements of the building, room or surrounding building. If loadbearing composite panels are removed from the construction, the structural performance of the room/building decreases.

Maximum open time:  
Maximum time interval after which an adhesive coat being applied loses its bonding ability.

Mobile cooler:  
Enclosed space, in which products can be stored, usually just above or below 0 °C, intended to be used to transport stored goods via road traffic.

Modified phenolic foam:  
Rigid cellular foam, the polymer structure of which is made primarily from the polycondensation of phenol, its homologues and/or derivatives, with aldehydes or ketones, modified with fire-retardants

and binding chemicals to obtain 100% closed cells.

Packaged food and/or feed:

Unprocessed produce, feeds or foods that are bottled, canned, cartoned, securely bagged, or securely wrapped in a container. Fruit and vegetables in bulk are also considered to be "packaged" food, while fruit and vegetables that have been cut or otherwise prepared for eating are considered unpackaged ("open food").

Panel joint:

Structure foreseen on the sides of the composite panels, usually designed to improve tightness (meeting edges of the composite panels).

Panel lock system:

System, which is an integral part of the composite panels, fastening panels to each other (e.g. cam-lock). Also referred to as "interlock" system.

Panels with transparent surfaces

Panels with factory-made openings and factory-applied transparent surfaces. Transparent surfaces for on-site incorporation into panels, are not covered by this ETA-Guideline.

Note: The assessment of panels with transparent surfaces is identical to that of the panels (see §5.2 and §6.2), but some additional assessment has been identified in §5.3 and §6.3.

Panic device:

A mechanism consisting of a bolt head(s) which engage(s) with a keeper(s) in the surrounding door frame or floor for securing a door when closed. The bolt head(s) can be released by the bar positioned horizontally across the inside face of the door when it is moved anywhere along its effective length in the direction of travel and/or in an arc downwards.

Partition (wall):

Possible component of a cold storage room kit, consisting of identically or similarly composed composite panels as wall panels. They may be relocatable within the room and may be fastened to walls and to other partitions to create compartments.

(envelope) Penetrations (entry ports)

Openings in wall or ceiling panels through which conduits, piping, thermometers, equipment, rotary shafts, and other functional parts enter into the assembled cold storage room.

Perimeter Kerb:

Provision, usually made out of concrete, situated at the basis of wall panels and/or partitions, fixed to the structure of the building, limiting the risk for (especially vehicular) impacts.

PET-film (co-laminate) :

Co-rolled Poly Ethylene Telephthalate (P.E.T) polymer film for metal sheet protection

Polyurethane coating:

Paint and coating for metal sheet protection

Pre-shaped panel intersection:

Prefabricated pre-shaped composite panel intersection (corners, intersections with partitions, curved panels), enabling the whole wall assembly to be composed of panels, without assembly profiles.

Pressure relieve system:

Provision, preventing build-up of negative (or positive) air pressure in the cold storage room (e.g. pressure relief valves (vents) or bursting discs).

Production shift:

Production corresponding with 6 to 8 h of continuous manufacturing.

#### Profiles:

Sections, which are part of the kit, usually of metal or plastic extrusions intended to assemble or finish the cold storage room. In the framework of this ETA-Guideline, the following terms are being used:

- Corner profiles (not supporting)  
Profiles, used to finish the joints in between floor, wall and/or ceiling panels (e.g. coved corner profiles, to prevent build-up of dirt in corners). These include skirting boards.
- Assembly profiles (not supporting)  
Profiles, used to assemble the cold storage room panels (e.g. U-profiles, fixed to the floor, in which wall panels are assembled or -profiles, as corner elements).
- Separating profiles  
Profiles, used to separate the cold storage room floor panel from the floor of the building (e.g. plastic, rectangular profiles).
- Supporting profiles  
Profiles, intended to support ceiling panels, usually with a rigid outer structure and thermally insulating core.

#### Protective measures:

Appropriate protective measures shall be taken when installing the ceiling panels and accessing the ceiling for maintenance purposes, especially in case of more frequent maintenance (e.g. servicing of equipment on the ceiling). These measures might consist of wooden boards or planks laid on a number of composite panels, dividing the loads involved uniformly over the surface of the panels.

#### PVC Plastisol:

Polyvinyl chloride based thermoplastic resin for metal sheet protection

#### PVC Laminate:

PVC film laminated onto metal sheet for protection

#### PVDF (PVF2):

Coating consisting of polyvinylidene fluoride and acrylic resin for metal sheet protection

#### Push-bar:

The activating horizontal bar of a panic device, designed to be fixed between pivoted support brackets, that operates in the direction of exit and/or in an arc downwards.

#### Push-pad:

An operating element of an emergency device which, when pushed in the direction of exit, operates the emergency device mechanism in order to release the bolt head(s).

#### Ramp:

Provision, facilitating access between two levels by a length of inclined surface. A ramp can be located either internal or external with regard to the cold storage room.

#### Rapid roll fabric door:

Provision, consisting of a fabric material, which quickly opens and shuts, reducing heat gains.

#### Refrigeration unit:

Technical equipment, producing cold temperatures within the cold storage room.

#### Relocatable cold storage room:

Cold storage room, which is installed with a view to possible later repositioning. The room, therefore, is capable of being dismantled and reinstalled without loss of properties and without substantial repair other than replacement of ancillary components such as seals and (sometimes) fixings. In general, the process itself might require a certain amount of skill and the use of tools.

#### Removable:

Capable of being detached from the parent unit, with the use of simple tools.

(readily) Removable:

Capable of being detached from the parent unit, without the use of simple tools.

Room:

Space in a building, enclosed by walls or partitions, and with a floor and ceiling, accessible for pedestrians (*and sometimes vehicles*), with minimum floor surface of 1 m x 1 m and minimum 2 m high.

Safety release:

Provision on the internal side of doors, which prevents entrapment or which ensures easy opening of doors in emergency or panic circumstances. Distinction is being made into panic and emergency devices.

Sandwich panel:

A prefabricated loadbearing or non-loadbearing composite panel, consisting of a thermally insulating core material and an interior and exterior face. An additional finishing can be foreseen on the faces.

These sandwich panels are divided into:

- panels with cores that are factory poured, injected or frothed (foamed-in-place) between panel faces and self adhere to the panel faces; and
- panels with slabstock (preformed slabs) cores that are adhered to panel faces, with an adhesive.

In the framework of this ETA-Guideline the general term “composite panel” is being used.

Sealant (jointing material or product):

Material in an unformed state, that when applied to a joint, seals it by adhering to the surfaces enabling the joint to prevent the passage of dust, moisture and/or gasses.

Self-supporting composite panels:

Composite panels, intended to be supported. Loads (e.g. self-weight, pedestrian traffic, technical equipment, etc.) are being transferred, at right angles with their planes, to structural supports of the building or room or surrounding building. Removing self-supporting panels does not influence the stability (structural capacity) of the room or the building.

Setting time:

Period of time, necessary for an adhesive to set under specified conditions. Setting is the process by which an adhesive develops its cohesive strength and thus the physical and chemical properties of its bond.

Shelf life (Storage life):

Period of time, under specified conditions, during which an adhesive can be expected to retain its working properties.

Shelving (or racking):

Provision, facilitating storage of products, by placing them on horizontal shelves.

Side lap:

Panel joint, made by a folding or profile of one or both the faces, which engages the adjacent composite panel to form an overlapping joint.

Single-faced composite panels: Composite panels consisting of a light weight core bonded to one relatively thin strong face.

Slabstock:

Core material, prefabricated prior to bonding between the two faces, which may be cut to size before bonding.

Smooth:

Free of pits, pinholes, cracks, crevices, inclusions, rough edges, and other surface imperfections detectable by visual or tactile inspection.

**Soil:**

Any unwanted matter, including product residues, micro-organisms, residual cleaning or disinfecting agents

**Storage:**

In the framework of this ETA-Guideline, "storage" not only refers to the storing of packaged or unpackaged goods, without any other simultaneous process taking place, but also to processes or treatments that stored goods undergo, while laying in the cold storage room (e.g. ageing of cheese). Production processes are however not covered.

**Strip curtain:**

Provision, usually made of plastic strips, preventing sudden heat gains, when opening doors.

**Supported enclosure:**

For its stability, the enclosure largely depends on a structural framework, other than the components of the enclosure itself.

**Supporting system:**

Load-bearing system, located inside or outside the cold storage room (or both), used to support the whole cold storage room or parts of it (usually the ceiling panel(-s) and/or hanging rails).

**Technical equipment:**

Mostly electrically operating provisions, influencing the internal conditions of the cold storage room, such as light, fire fighting services, sprinklers, defrost systems, computer and telecommunication cables, refrigerating units (cool units), air curtains and their operating systems, provisions influencing humidity, operating doors and/or windows and sanitary provisions.

**Tongue and groove joint:**

A joint between the edges of panels forming a smooth wall, floor, or ceiling surface. The tongue in one panel fits the groove of its neighbour.

**Touch-bar:**

The activating horizontal bar of a panic device, designed to be part of a chassis or other mounting assembly, that operates in the direction of exit.

**Walkability:**

Characteristic of a ceiling panel to resist (maintenance) access loads either during or after construction. A typical access load may be caused by an operative carrying a load across a ceiling.

**Wall protection provisions:**

Provisions, preventing mechanical damage (impacts, abrasion) to the wall panels and doors by external causes. These may be part of the kit, e.g. bumper bars (guards), handrails, etc., or provisions installed on site (see chapter 7), like concrete perimeter kerbs, crash barriers, etc..

**Windows:**

Component for closing vertical openings in a wall, that will admit light. In the framework of this ETA-Guideline, the term "window" is only used to indicate kit components with window frames. Panels with factory-made openings and factory-applied transparent surfaces are referred to as "panels with transparent surfaces".

**Wood-based panel:**

Solid wood panel, laminated veneer lumber, plywood, oriented strand board, resin- or cement-bonded particleboard or fibreboard (hard, medium or soft fibreboard).

**Working life (Pot life):**

Period of time during which a multi-part adhesive can be used after mixing the components.

**B.2 Specific abbreviations related to the products and their intended use covered by this Guideline**

CG	Cellular Glass
EPS	Expanded Polystyrene
GRP	Glass fibre reinforced polyester
MW	Mineral Wool
PF	Phenolic Foam
PIR	Polyisocyanurate Foam
PUR	Polyurethane Foam
XPS	Extruded Polystyrene

## ANNEX C

### LIST OF REFERENCE DOCUMENTS

ETA-Guideline 001	Anchors
ETA-Guideline 003	Internal Partition Kits
Draft ETA-Guideline XX1	Fire sealing and fire stopping products
ETA-Guideline 016	Self-supporting light weight composite panels
EOTA TR001	Determination of impact resistance (WG doc. 118 rev.2)
M.O.A.T. No. 59:1996	UEAtc Technical report for the assessment of installations using sandwich panels with a CFC-free polyurethane foam core
EN 179:1997/prA1	Building hardware - Emergency exit devices operated by a lever handle or push pad - Requirements and test methods
EN 410:1998	Glass in building - Determination of luminous and solar characteristics of glazing
EN 485-2:1995	Aluminium and aluminium alloys - Sheet, strip and plate - Mechanical properties
EN 542:1995	Adhesives - Determination of density
EN 573-3:2003	Aluminium and aluminium alloys - Chemical composition and form of wrought products - Chemical composition
EN 755-1:1997	Aluminium and aluminium alloys - Extruded rod/bar, tube and profiles - Part 1: Technical conditions for inspection and delivery
EN 947:1998	Hinged or pivoted doors - Determination of the resistance to vertical load
EN 948:1999	Hinged or pivoted doors - Determination of the resistance to static torsion
EN 949:1998	Windows and curtain walling, doors, blinds and shutters - Determination of the resistance to soft and heavy body impact for doors
EN 950:1999	Door leaves - Determination of the resistance to hard body impact
EN 951:1998	Door leaves - Method for measurement of height, width, thickness and squareness
EN 952:1999	Door leaves - General and local flatness - Measurement method
EN 1026:2000	Windows and doors - Air permeability - Test method
EN 1027:2000	Windows and doors - Watertightness - Test method
EN 1121:2000	Doors - Behaviour between different climates - Test method
EN 1125:1997/prA1	Building hardware - Panic exit devices operated by a horizontal bar - Requirements and test methods
EN 1172:1997	Copper and copper alloys. Sheet and strip for building purposes
EN 1191:2000	Windows and doors - Resistance to repeated opening and closing - Test method
EN 1192:2000	Doors - Classification of strength characteristics
EN 1195:1998	Timber structure – Test methods – Performance of structural floor decking
EN 1396:1997	Aluminium and aluminium alloys - Coil coated sheet and strip for general applications - Specifications
EN 1527:1998	Building hardware - Hardware for sliding doors and folding doors - Requirements and test methods
EN 1607:1997	Thermal insulating products for building applications - Determination of tensile strength perpendicular to faces
EN 1609:1997	Thermal insulating products for building applications - Determination of short term water absorption by partial immersion
EN 1670:1998	Building hardware - Corrosion resistance - Requirements and test methods
EN 1990:2002	Eurocode - Basis of structural design
EN 1991-1-1:2002	Eurocode 1: Actions on structures - Part 1-1: General actions - Densities, self-weight, imposed loads for buildings
EN 1992-1-1	Eurocode 2: Design of concrete structures - Part 1-1: General - Common rules for building and civil engineering structures (will replace ENV 1992-1-1:1991, ENV 1992-1-3:1994, ENV 1992-1-4:1994, ENV 1992-1-5:1994 and ENV 1992-1-6:1994)
EN 1992-1-2	Eurocode 2: Design of concrete structures - Part 1-2: General rules - Structural fire design (will replace ENV 1992-1-2:1995)
EN 1993-1-1	Eurocode 3: Design of steel structures - Part 1-1: General rules (will replace ENV 1993-1-1:1992)
EN 1993-1-2	Eurocode 3: Design of steel structures - Part 1-2: General rules - Structural fire design (will replace ENV 1993-1-2:1995)



EN 1993-3	Eurocode 3: Design of steel structures - Part 3: Buildings (will replace ENV 1993-1-1:1992)
EN 1993-1-8	Eurocode 3: Design of steel structures - Part 1.8 : Design of joints
EN 1994-1-1	Eurocode 4: Design of composite steel and concrete structures - Part 1-1: General - Common rules and rules for buildings (will replace ENV 1994-1-1:1992)
EN 1994-1-2	Eurocode 4: Design of composite steel and concrete structures - Part 1-2: Structural rules - Structural fire design
EN 1995-1-1	Eurocode 5: Design of timber structures - Part 1-1: General rules
EN 1995-1-2	Eurocode 5: Design of timber structures - Part 1-2: General rules - Structural fire design (will replace ENV 1995-1-2:1994)
EN 1999-1-1	Eurocode 9: Design of aluminium structures - Part 1-1: General - Common rules (will replace ENV 1999-1-1:1998)
EN 1999-1-2	Eurocode 9: Design of aluminium structures - Part 1-2: General - Structural fire design (will replace ENV 1999-1-2:1998)

Note: Currently, most Eurocodes are draft standards. These standards can only be used when elaborating ETAs, if they have been published (see EC Guidance Paper L).

EN 10088-1:1995	Stainless steels – Part 1: List of stainless steels
EN 10088-2:1995	Stainless steels – Part 2: Technical delivery conditions for sheet/plate and strip for general purposes
EN 10152:2003	Electrolytically zinc coated cold rolled steel flat products - Technical delivery conditions
EN 10169-1:1997	Continuously organic coated (coil coated) steel flat products - Part 1: General information (definitions, materials, tolerances, test methods)
ENV 10169-2:1999	Continuously organic coated (coil coated) steel flat products - Part 2: Products for building exterior applications
EN 10169-3:2003	Continuously organic coated (coil coated) steel flat products - Part 3: Products for building interior applications
EN 10326:2004	Continuously hot-dip coated strip and sheet of structural steels - Technical delivery conditions
EN 10327:2004	Continuously hot-dip coated strip and sheet of low carbon steels for cold forming - Technical delivery conditions
EN 12046-1:2003	Operating forces - Test method - Part 1: Windows
EN 12046-2:2000	Operating forces - Test method - Part 2: Doors
EN 12087:1997	Thermal insulating products for building applications - Determination of long term water absorption by immersion
EN 12210:2000	Windows and doors - Resistance to wind load – Classification
EN 12092:2001	Adhesives - Determination of viscosity
EN 12211:2000	Windows and doors - Resistance to wind load - Test method
EN 12114:2000	Thermal performance of buildings - Air permeability of building components and building elements - Laboratory test methods
EN 12207:1999	Windows and doors - Air permeability - Classification
EN 12208:1999	Windows and doors - Watertightness - Classification
EN 12217:2003	Doors - Operating forces - Classification
EN 12219:2000	Doors – Climatic influences – Requirements and classification
EN 12608:2003	Unplasticized polyvinylchloride (PVC-U) profiles for the fabrication of windows and doors – Classification, requirements and test methods
EN 12365-1:2003	Building hardware – Gasket and weatherstripping for doors, windows, shutters and curtain walling – Part 1: Performance requirements and classification
EN 12400:2002	Windows and doors – Mechanical durability – Requirements and classification
EN 12412-2:2003	Thermal performance of windows, doors and shutters – Determination of thermal transmittance by hot box method – Frames
EN 12445:2001	Industrial, commercial and garage doors and gates - Safety in use of power operated doors - Test methods
EN 12524:2000	Building materials and products - Hygrothermal properties - Tabulated design values
EN 12871:2001	Wood-based panels – Performance, specification and requirements for load-bearing boards for use in floors, walls and roofs
EN 12978:2003	Industrial, commercial and garage doors and gates - Safety devices - Requirements

	and test methods
EN 13115:2001	Windows - Classification of mechanical properties - Racking, torsion and operating forces
EN 13162:2001	Thermal insulation products for buildings - Factory made mineral wool (MW) products - Specification
EN 13163:2001	Thermal insulation products for buildings - Factory made products of expanded polystyrene (EPS) - Specification
EN 13164:2001	Thermal insulation products for buildings - Factory made products of extruded polystyrene foam (XPS) - Specification
EN 13165:2001	Thermal insulation products for buildings - Factory made rigid polyurethane foam (PUR) products - Specification
EN 13166:2001	Thermal insulation products for buildings - Factory made products of phenolic foam (PF) - Specification
EN 13167:2001	Thermal insulation products for buildings - Factory made products of cellular glass (CG) - Specification
ENV 13240:2000	Windows - Behaviour between different climates - Test method
EN 13241-1:2003	Industrial, commercial and garage doors and gates - Product standard – Part 1: Products without fire resistance or smoke control characteristics
EN 13501-1:2001	Fire classification of construction products and building elements - Part 1: Classification using test data from reaction to fire tests
EN 13501-2:2002	Fire classification of construction products and building elements - Part 2: Classification using test data from fire resistance tests
EN 13523-1:2001	Coil coated metals - Test methods - Coating thickness
EN 13523-2:2001	Coil coated metals - Test methods - Specular gloss
EN 13523-4:2001	Coil coated metals. Test methods. Pencil hardness
EN 13523-5:2001	Coil coated metals. Test methods. Resistance to rapid deformation (impact test)
EN 13523-6:2002	Coil coated metals - Test methods - Part 6: Adhesion after indentation (cupping test)
EN 13523-7:2001	Coil coated metals. Test methods. Resistance to cracking on bending (T-bend test)
EN 13523-8:2002	Coil coated metals - Test methods - Part 8: Resistance to salt spray (fog)
EN 13523-9:2001	Coil coated metals - Test methods - Part 9: Resistance to water immersion
EN 13523-10:2001	Coil coated metals. Test methods. Resistance to fluorescent UV light and water condensation
EN 13523-13:2001	Coil coated metals - Test methods - Part 13: Resistance to accelerated ageing by the use of heat
EN 13523-14:2001	Coil coated metals - Test methods - Part 14: Chalking (Helmen method)
EN 13523-18:2002	Coil coated metals - Test methods - Part 18: Resistance to staining
EN 13829:2000	Thermal insulation - Determination air permeability of buildings - Fan pressurisation method (ISO 9972:1996, modified)
EN 13986:2001	Wood-based panels for use in construction - Characteristics, evaluation of conformity and marking
EN ISO 527-1:1996	Plastics - Determination of tensile properties - Part 1: General principles
EN ISO 527-2:1996	Plastics - Determination of tensile properties - Part 2: Test conditions for moulding and extrusion plastics
EN ISO 845:1995	Cellular plastics and rubbers - Determination of apparent (bulk) density
EN ISO 1856:2001	Flexible cellular polymeric materials - Determination of compression set
EN ISO 2884-1:1999	Methods of test for paints - Tests on liquid paints (excluding chemical tests) - Determination of the viscosity of paint at a high rate of shear - Part 1: Cone and plate viscometer
EN ISO 3251:1995	Paints and varnishes - Determination of non-volatile matter of paints, varnishes and binders for paints and varnishes
EN ISO 4628-2:2003	Paints and varnishes - Evaluation of degradation of coatings – Designation of quantity and size of defects, and of intensity of uniform changes in appearance - Part 2: Assessment of degree of blistering
EN ISO 4892-2:2000	Plastics - Methods of exposure to laboratory light sources - Xenon-arc sources
EN ISO 6270-1:2001	Paints and varnishes - Determination of resistance to humidity - Continuous condensation
EN ISO 6946:1996	Building components and building elements - Thermal resistance and thermal transmittance- Calculation method
EN ISO 9001:2000	Quality management systems - Requirements

EN ISO 10077-1:2000	Thermal performance of windows, doors and shutters. Calculation of thermal transmittance – Part 1: Simplified method
EN ISO 10077-2:2003	Thermal performance of windows, doors and shutters - Calculation of thermal transmittance - Part 2: Numerical method for frames (ISO/DIS 10077-2:1998)
EN ISO 10211-1:1995	Thermal bridges in building construction - Heat flows and surface temperatures - Part 1: General calculation methods
EN ISO 10211-2:2001	Thermal bridges in building construction - Heat flows and surface temperatures - Part 2: Linear thermal bridges
EN ISO 12567-1:2000	Thermal performance of windows and doors - Determination of thermal transmittance by hot box method - Complete windows and doors
EN ISO 12572:2001	Hygrothermal performance of building materials and products - Determination of water vapour transmission properties
EN ISO 12569:2001	Thermal insulation in buildings - Determination of air change in buildings - Tracer gas dilution method
EN ISO 12944-3:1998	Paints and varnishes - Corrosion protection of steel structures by protective paint systems – Part 3: Design considerations
EN ISO 13788:2001	Hygrothermal performance of building components and building elements - Estimation of internal surface temperature to avoid critical surface humidity and assessment of the risk of interstitial condensation
EN ISO 13793:2001	Thermal performance of buildings – Thermal design of foundations to avoid frost heave
ISO 844:2001	Rigid cellular plastics - Determination of compression properties
ISO 8339:1984	Building construction - Jointing products - Sealants - Determination of tensile properties
ISO 9047:1989	Building construction - Sealants - Determination of adhesion/cohesion properties at variable temperatures
ISO 10364:1993	Methods of test for adhesives - Determination of pot life
ISO 10590:1991	Building construction - Sealants - Determination of adhesion/cohesion properties at maintained extension after immersion in water
ISO 11431:1993	Building construction - Sealants - Determination of adhesion/cohesion properties after exposure to heat and artificial light through glass and to water
ISO 11600:1993	Building construction - Sealants - Classification and requirements
prEN 13241-2	Industrial, commercial and garage doors and gates - Product standard – Part 2: Products without fire resistance or smoke control characteristics
prEN 13637	Building hardware - Electrically controlled emergency exit systems - Requirements and test methods
prEN 13916	Fire resisting doorsets - Requirements and classification
prEN 14013	Smoke control doorsets - Requirements and classification
prEN 14351-1	Windows and pedestrian doorsets - Product standard - Part 1: Windows and external pedestrian doorsets without resistance to fire and external fire characteristics
prEN 14351-2	Internal pedestrian doors - Product Standard - Part 1: Internal pedestrian doorsets without resistance to fire characteristics
prEN 14351-3	Windows and pedestrian doorsets - Product Standard - Part 3: Products with resistance to fire and external fire characteristics
prEN 14509	Double metal faced insulated sandwich panels
prEN 14592	Timber structures - Fasteners - Requirements
prEN ISO 14683	Thermal bridges in building construction - Linear thermal transmittance - Simplified methods and default values (ISO/DIS 14683:2005)

## ANNEX D

### TEST METHODS FOR DETERMINING THE RACKING RESISTANCE

#### D.1 Objective

The objective of these tests is to determine the racking resistance provided by panels or vertical wall elements. This test specification follows the principles of EN 594, but has been adapted to cover a range of products and assemblies.

The racking resistance test simulates the behaviour of a composite panel or wall assembly, resulting from a load being exercised in the plane of the panel (e.g. an object leaning against the panel assembly or wind loads).

Note: This test method is intended to determine the racking resistance with regard to safety in use. The racking strength at which the serviceability requirements (e.g. water vapour tightness, thermal performance) are no longer being met, is considerably smaller.

#### D.2 Principle

The test method measures the resistance to racking load of panels or vertical wall elements, which can deform both vertically and horizontally in the plane of the panel.

In this test method, the panel is fastened to the substrate in accordance with manufacturer's specifications, ensuring that the test result corresponds with behaviour in normal use.

#### D.3 References

This test method is derived from the following reference document:

- ASTM E72-98 Standard test methods of conducting strength tests of panels for building construction
- EN 594:1996 Timber structures - Test methods - Racking strength and stiffness of timber frame wall panels

#### D.4 Definitions

##### **racking strength**

capacity of a panel to resist a horizontal load in the plane of the panel

##### **racking stiffness**

calculated stiffness of a panel when it is loaded to approximately 40% of its racking strength

#### D.5 Symbols

$F$	applied racking load, in N;
$F_{max}$	maximum racking load, in N;
$F_{max,est}$	estimated maximum racking load, in N;
$F_v$	applied vertical load, in N;
$R$	racking stiffness, in N/mm;
$v$	panel deformation, in mm.

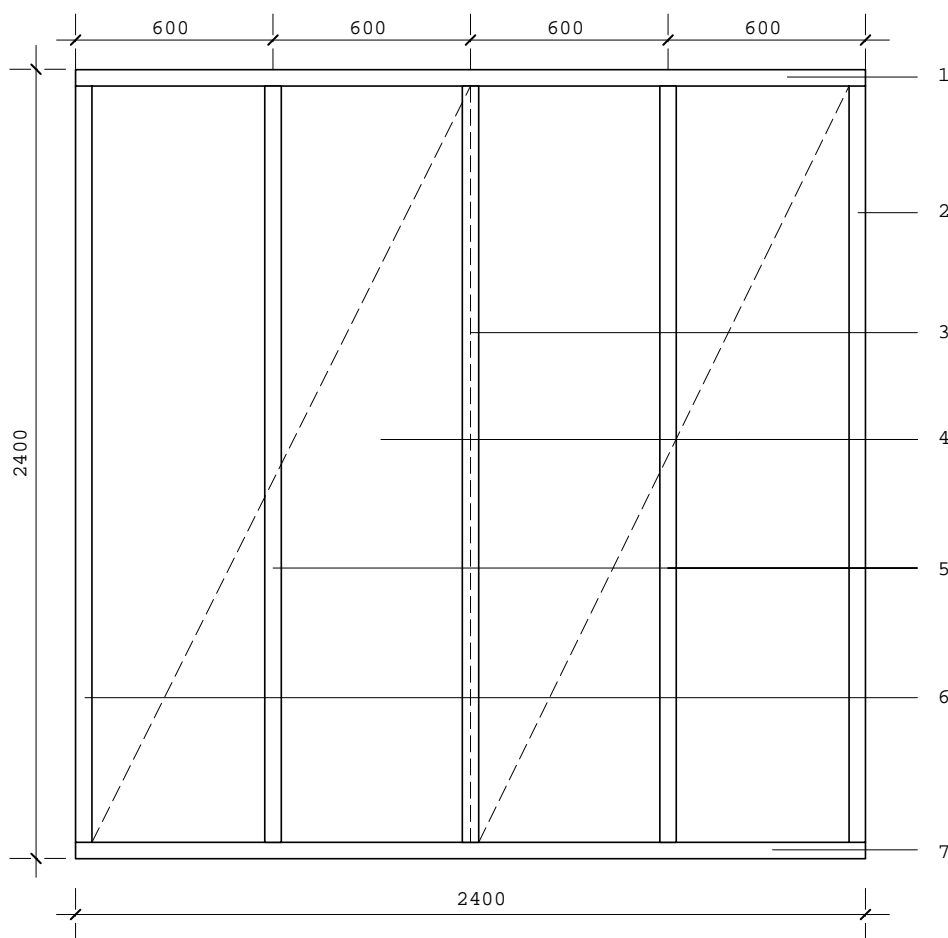
#### D.6 Test Specimen

The test specimen should have the maximum height and width of the components covered by the ETA. An example is shown in Figure D.1.

Notes:

- 1) Typical test specimens are 2,4 m x 2,4 m panels or panels the width and height of the building or room kit or unit.
- 2) Typical panel types for building or room kits or units that should be tested include:
  - An external wall end with maximum window opening — the preferred size for this element is the maximum actual height by the maximum width of the end panel to be covered by the ETA

- An external wall with no window opening
- An internal non load-bearing wall panel



**Figure D.1: Details of test panels (example)**

<b>Key</b>	4 Two 1200 mm wide faces joined on centre stud
1 Top rail	5 Intermediate studs
2 Trailing stud	6 Leading stud
3 Centre stud	7 Bottom rail

## D.7 Number of tests

The test shall be carried out on the most onerous test assembly, unless different assemblies are covered by the ETA, depending on the intended uses and in case the ETA-applicant claims performances for more than one. However, wherever possible, more than one structure of the same design and loading regime should be tested to permit the assessment of the likely variability in performance.

If the interface (connection) between panels or wall elements is being assessed, 2 tests should be performed, i.e. a test with one panel (for those cases where the panels are not connected) and a test with 2 panels (for those cases where the panels are connected).

Note 1: Different panels should be tested for each condition of vertical load (see D.12.2 and D.12.3). Normally it is sufficient to test the maximum and minimum conditions of vertical load appropriate to the design of the panel.

Note 2: The number of panels tested will depend on the variability in materials and manufacture, the required level of confidence and the number of loading conditions to be applied.

## D.8 Characterisation

The detailed specification of the panel or element shall be provided and checks carried out to verify

compliance with the specification. Such checks include:

- dimensions of the panel or wall element
- dimensions of structural members (if any)
- spacing of structural members
- dimensions and specification of face and core materials
- fixing details, etc

Note: Verifying characterisation data may not be necessary if sample taking was performed by the Approval body, but the test report should at least present this information (if applicable).

## **D.9 Preparation of specimens**

The sample conditioning shall be recorded. The conditioning period shall be agreed between the ETA-applicant and the Approval Body.

The test shall be carried out in laboratory circumstances.

## **D.10 Test apparatus**

### **D.10.1 Loading apparatus**

The test apparatus shall be in accordance with the schematic presentation in Figure D.2 and with the detailed specifications as set out below, or equivalent.

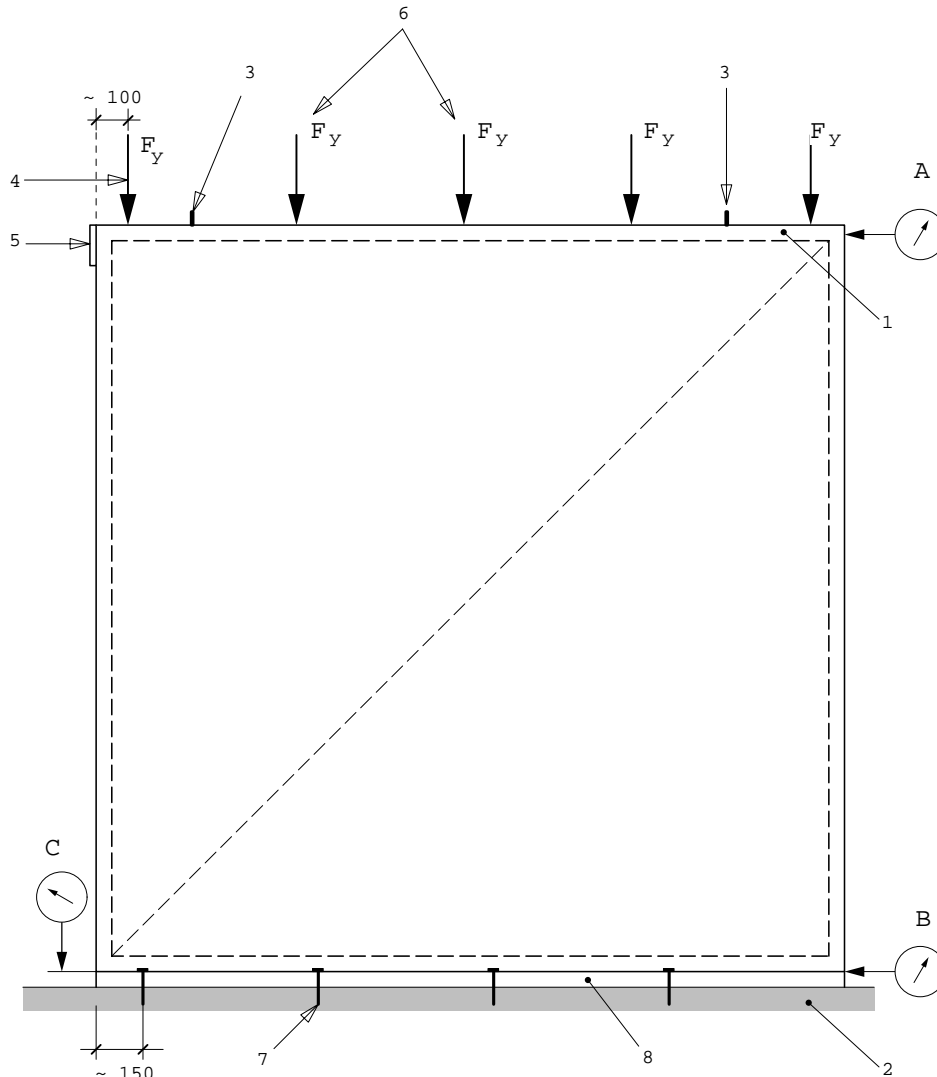
It shall be capable of applying, separately, both racking load  $F$ , and vertical loads  $F_v$ . The method of application of the loads shall be such that no significant resistance to movement in the panel is induced.

The apparatus shall be capable of continuously recording the loads  $F$  and  $F_v$  with an accuracy of  $\pm 3\%$  of the load applied, or, for loads of less than  $0,1 \times F_{\max,est}$  with an accuracy of  $\pm 0,3\% F_{\max,est}$ . The panel displacements shall be measured to the nearest 0,1 mm.

If necessary, a metal casing shall be used to prevent the load being applied on only the composite panel core or facing or on parts of a designed panel joint, causing unrepresentative local deformations.

### **D.10.2 Deflection transmitter**

A deflection transmitter, fixed to the side of the panel assembly opposite the application point of the load.



**Figure D.2: Test apparatus**

**Key**

- 1 Head binder
- 2 Base of test rig
- 3 Lateral restraints arranged so as to not impede movement of panel within its plane
- 4 Leading loading point set back if using fixed loading position allowing 100 mm maximum racking deflection
- 5 Racking load ( $F$ ) applied at top of panel or to metal plate attached to top rail of panel and head binder
- 6 Vertical load spread equally to each stud (or equivalently distributed) and applied so as not to impede racking reflection on panel
- 7 Fastening system in accordance with manufacturer's specifications
- 8 Timber packer of similar section as the panel

**D.11 Test assembly**

**D.11.1 Panel assembly or wall element**

The panel assembly consists either of 1 panel, in case adjacent panels are not interlocked, or 2 panels and shall be mounted in accordance with the ETA-applicant's installation specifications, with regard to the intended use, so that the test assembly corresponds as much as possible with the end-use conditions.

The way in which components are fixed to each other and to the floor shall be in accordance with the ETA-applicant's specifications and reproduce actual conditions of use, particularly with respect to the nature, type and position of the fixings and the distance between them.

If the ETA-applicant's specifications foresee more than one possible end-use assembly, the Approval Body should at least perform the test on the most onerous one. The ETA-applicant has the

possibility to test additional assemblies, if he claims better performance.

In principle, for composite panels, the most onerous assembly shall be the following:

- Panel: the panel with the highest ratio length (or height) over width in its minimum thickness
- Span: Maximum distance between supports

### **D.11.2 Base and loading frame**

The base of the test assembly shall provide a level bed to receive the test panel. The base shall be sufficiently stiff so as not to distort during the test. A rigid datum (independent of the test rig) shall be provided for the measurement of the deformation of the panel.

### **D.11.3 Mounting of test panel**

The head binder shall be rigidly attached to the top rail or top of the panel. The cross-sectional dimensions and position shall provide a firm interface between the loads and the panel and allow the free movement of the panel sheathing of faces during the test. Lateral restraints shall be provided through the head binder so that the head or top of the panel will deflect only in the plane of the panel.

## **D.12 Test procedure**

### **D.12.1 General**

The vertical loads  $F_v$  shall be applied at locations appropriate to the design of the panel normally above the stud positions as shown in Figure D.2 (or equivalently distributed). The method of application of the vertical loads shall allow for racking deflections up to 100 mm.

If fixed jacking points are used, the vertical load on the stud nearest the point of application of the racking load shall be positioned approximately 100 mm from the end of the panel (see Figure D.2). The racking load  $F$  shall be applied as shown in Figure D.2. The load shall be applied at a constant rate of movement related to the displacement at gauge A.

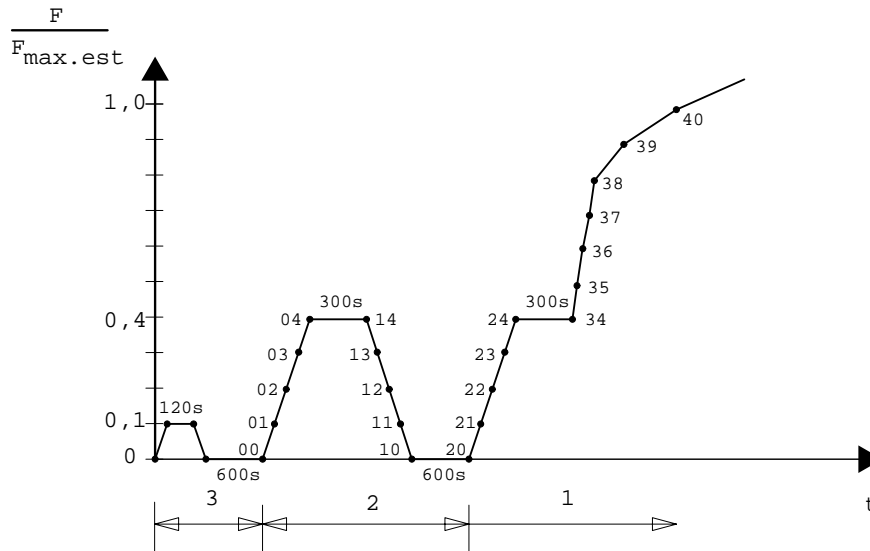
For loading and unloading up to  $0,4 \times F_{\max,est}$  the rate of loading shall be  $(2 \pm 0,5)$  mm/min. For loading above  $0,4 \times F_{\max,est}$  this rate of loading shall be  $(4 \pm 1)$  mm/min. The displacements of the panel shall be monitored at points A, B and C (see Figure D.2). The deformation  $v$  shall be taken as the displacement at A minus the displacement at B. The displacement at C shall be reported separately. The procedure for applying the racking load, shown in Figure D.3, shall be used.

### **D.12.2 Vertical preload**

In some cases, e.g. when the vertical loads  $F_v$  to be applied in the stiffness or strength tests are less than 1 kN per stud (or equivalent), a vertical preload cycle is required. The procedure is carried out by applying vertical preloads of  $1 \text{ kN} \pm 10\%$ .

These loads shall be maintained for  $(120 \pm 10)$  s, then released and the panel allowed to recover for a minimum of  $(300 \pm 10)$  s before continuing the test.

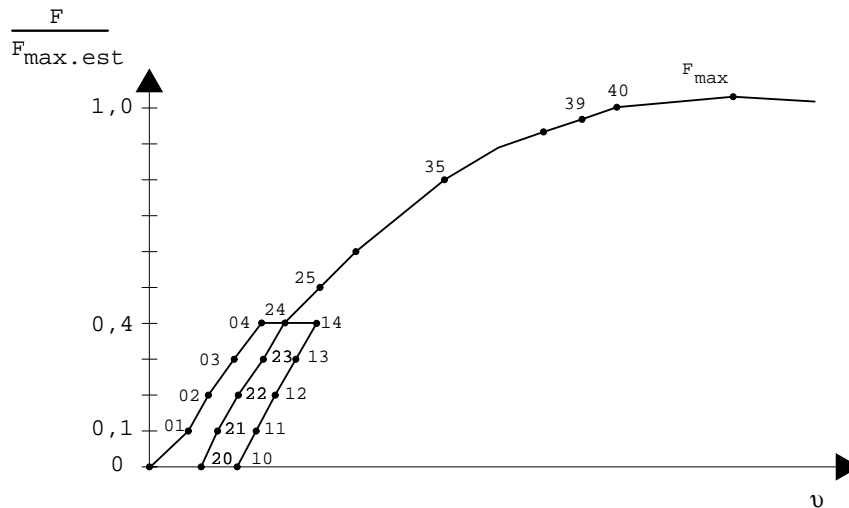




**Figure D.3: Diagramme racking load versus time**

Key  
1 Strength test

2 Stiffness load cycle  
3 Stabilising load cycle



**Figure D.4: Typical racking load versus deflection curve**

### D.12.3 Stabilising load cycle

The vertical loads  $F_v$  shall be applied to the head binder at the stud positions (or equivalent), as shown in Figure D.2 and maintained constant throughout the cycle. The racking load  $F$  shall then be applied and increased to  $0,1 \times F_{max,est}$  and maintained for  $(120 \pm 10)$  s. It shall then be removed and the panel allowed a recovery period of  $(600 \pm 300)$  s, before continuing the test.

### D.12.4 Stiffness load cycle

Maintain the vertical loads  $F_v$  applied in the stabilizing load cycle. The racking load  $F$  shall then be applied and increased to  $0,4 \times F_{max,est}$ , and maintained for  $(300 \pm 10)$  s. It is then removed and the panel is allowed a recovery period of  $(600 \pm 300)$  s. The deformations  $v_{01}$  and  $v_{10}$  and the corresponding racking loads  $F_1$  to  $F_{10}$  shall be recorded (see Figure D.4).

### D.12.5 Strength test

Maintain the vertical loads  $F_v$  applied in the stabilizing load cycle. The racking load  $F = 0,4 \times F_{max,est}$  shall then be applied and this load shall be maintained for  $(300 \pm 10)$  s. The racking load  $F$

shall then be increased until  $F_{max}$  is reached. The racking load shall be applied at the rate specified above (see D.12.1).

Note 1. The rate of loading should ensure that 90 % of the racking load  $F_{max}$  is reached within  $(300 \pm 120)$  s. It is advised that the mean time to this load is about 300 s.

Note 2. See D.12.2 for a description of the relationship between  $F_{max,est}$  and  $F_{max}$ .  
 $F_{max}$  is reached when either:

- the panel collapses, or
- the panel attains a deformation  $v$  (see D.12.1) of 100 mm, whichever occurs first.

The deformations  $v_{20}$  and  $v_{40}$  and the corresponding racking loads shall be recorded (see Figure D.4).

Note 3. It is important to ensure that the panel has totally failed when the racking load begins to reduce; it is common for panels to recover the load lost when individual fixings fail by redistributing the load to the remaining fixings.

## D.12.6 Expression of results

The test results shall contain:

- a) racking stiffness of the panel, calculated from the equation  
$$R = 0,5 \times ((F_4 - F_1) / (v_{04} - v_{01}) + (F_{24} - F_{21}) / (v_{24} - v_{21}))$$

Where:

  - $F_1$  is the racking load of  $0,1 \times F_{max,est}$ , in N, and  $v_{01}$  is the deformation, in mm, and
  - $F_4$  is the racking load of  $0,4 \times F_{max,est}$ , in N, and  $v_{04}$  is the deformation, in mm as determined in the stiffness test;
  - $F_{21}$  is the racking load of  $0,1 \times -F_{max,est}$ , in N, and  $v_{21}$  is the deformation, in mm and
  - $F_{24}$  is the racking load of  $0,4 \times F_{max,est}$ , in N, and  $v_{24}$  is the deformation, in mm, as determined in the strength test;
- b) racking strength, expressed as the value of the maximum racking load  $F_{max}$  as found in the strength test;
- c) vertical loads  $F_v$  the total vertical load, and the nominal spacing of the studs (if relevant);
- d) a record of the displacement at C (see Figure D.2).

## D.13 Test report

The test report shall include at least the following information:

- a) reference to this EOTA ETA-Guideline, Annex D
- b) the name of the testing laboratory
- c) the name of the ETA-Applicant (and manufacturer of the composite panel)
- d) date of the test
- e) description of the test instruments
- f) identification of the product tested (designation, dimensions and any relevant identification characteristic, e.g. moisture content of the timber framing and the sheathing material)
- g) identification of the sample(-s) tested (dimensions, shape, etc.) and reference to its marking (if any)
- h) surface structure (e.g. smooth, profiled, structured, ...)
- i) description of conditioning and preparation of the sample (if any)
- j) the speed of applying the load
- k) description of test conditions (temperature and RH)
- l) test loads attained during the tests together with the corresponding deformations at all measurement positions; the vertical loads  $F_v$  applied in the racking stiffness and strength tests
- m) values of  $R$  and  $F_{max}$  and the circumstances in which  $-F_{max}$  occurred;
- n) gap between the sheets in the panel (if any);
- o) direction of greater strength of the sheathing material;
- p) specification of the mechanical fasteners (including corrosion protection), and their quantity and positioning;
- q) any deviation in panel construction from that shown in Figure D.1;
- r) description of the method of loading the panel and of measuring the panel deformations;
- s) type and position of any failure, including failures that have no relationship with the racking resistance of the panel (e.g. failure of the connection to the substrate);

## **ANNEX E**

### **TEST METHODS FOR DETERMINING THE RESISTANCE TO AXIAL LOADS**

#### **E.1 Principle**

The test methods given below simulate the behaviour of composite panels under various axial loads (e.g. ceiling panels being supported by wall panels).

In the test, a wall panel is placed vertically and compressed to determine the deformation and lateral deflection, and thus the axial load-bearing capacity of the panel.

#### **E.2 References**

These test methods are derived from the following reference documents:

ASTM E72-98	Standard test methods of conducting strength tests of panels for building construction
DIS ISO 8413:1990	Performance Standards in Building – Partitions made from Components Tests for Ability to withstand Suspended Static Loads.

#### **E.3 Test apparatus**

The apparatus shall be assembled as shown below (figure E.1) and shall be in accordance with the detailed specifications as set out below, or equivalent.

A deflection transmitter, fixed to the face of the panel, in the middle of the panel. A compression transmitter shall be attached to the top of the panel.

If necessary, a metal casing shall be used to prevent the load being applied on only the composite panel core or facing or on parts of a designed panel joint, causing unrepresentative local deformations.

#### **E.4 Number of tests**

The test shall be carried out on one panel, for each type of test. In case of unsymmetrical panels, these shall be tested in each axis for which the result may be different.

#### **E.5 Conditioning and test conditions**

The sample conditioning shall be recorded. The conditioning period shall be agreed between the ETA-applicant and the Approval Body.

The test shall be carried out in laboratory circumstances, at a temperature of  $(23 \pm 5)$  °C, where required.

#### **E.6 Test assembly**

##### **E.6.1 General**

The panel assembly shall be mounted in accordance with the ETA-applicant's installation specifications, with regard to the intended use, so that the test assembly corresponds as much as possible with the end-use conditions. The way in which components are fixed shall be in accordance with the ETA-applicant's specifications and reproduce actual conditions of use, particularly with respect to the nature, type and position of the fixings and the distance between them.

##### **E.6.2 Behaviour under normal conditions**

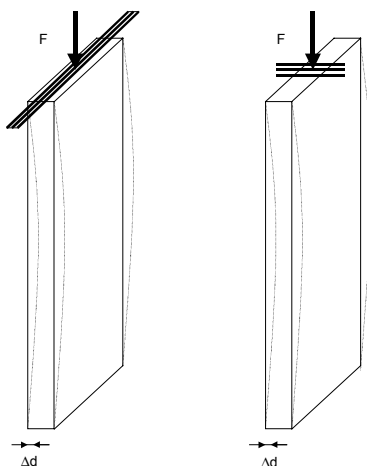
The panel assembly consists of 1 panel.

In principle, the most onerous panel shall be tested, i.e. the panel with the highest ratio length (or height) over width in its minimum thickness.

Depending on the nature of the loads under end-use conditions, a uniformly distributed load or a point load shall be applied in the axis of the panel (see Figure E.1).

As far as possible, ETA-applicant's specifications shall be taken into account with regard to applying the loads, in order for the test results to correspond to the end-use conditions as much as possible.

Note: The point load usually represents a profile, intended to support ceiling panels. Therefore, the point load should have a surface, corresponding with the supported part of the profile, although this does not correspond with the situation in reality, due to re-distribution of loads along the ceiling panels. The test procedure is however considered more onerous and therefore safe.



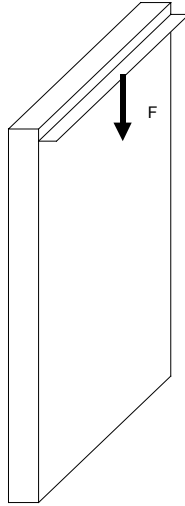
**Figure E.1**

### **E.6.3 Behaviour under eccentric axial loads**

In case load-bearing systems are part of a composite panel kit (e.g. profiles attached to a wall panel, to support ceiling panels - see figure E.2), the load-bearing capacity in the plane of the panel shall be tested by applying a load during a given time period.

The load-bearing system shall be applied in accordance with the ETA-applicant's specification. The way in which components are fixed to each other shall reproduce actual conditions of use, particularly with respect to the nature, type and position of the fixings and the distance between them.

Note: The inclusion of this test method does not mean that these solutions are favoured or even approved by the Approval Bodies, e.g. with regards to thermal resistance and water vapour tightness.



**Figure E.2**

## **E.7 Test procedure**

### **E.7.1 For axial load resistance**

The panels shall be tested as a column, having a flat end at the bottom. Compressive loads shall be applied to a steel plate covering the upper end of the assembly. Apply the load uniformly along a line parallel to the inside face, and one-third the thickness of the assembly from the inside face, in case this corresponds with the end-use application, or as a concentrated load on a steel plate with corresponding dimensions.

For wood construction, a rate of loading corresponding to a movement of the testing machine crosshead of nominally 0,8 mm/min has been found satisfactory.

Attach four compression meters to the faces of the specimen, one near each corner of the specimen as shown below, to measure the shortening of the assembly. Record the readings to the nearest 0,025 mm.

Attach two deflection meters, one to each edge of the assembly (See figure E.1). Record the readings continuously, to the nearest 0,25 mm.

### **E.7.2 For eccentric axial load resistance**

The eccentric axial load resistance shall be tested on an assembly which corresponds with the ETA-applicant's specification and installation requirements.

Loads shall be applied and removed at a rate of approximately 2000 N/min. Functional failure loads (i.e. 500 N, 2000 N or 5000N) shall not remain between application and removal. Structural damage loads (i.e. 1000 N, 4000 N or 10000N) shall remain for 24 hours between application and removal.

The maximum deflection under load and the residual deflection shall be reported. Note shall be made of any damage caused.

## **E.8 Expression of test results**

### **E.8.1 Deformation**

For each compression meter, calculate the shortening under each load as the difference between the reading of the compression meter when the load is applied and the initial reading. Calculate the shortening of the panel as the average of the shortenings for each of the four compression meters, multiplied by the ratio: specimen length divided by the compression meter gauge length.

Obtain the sets in a similar manner.

### **E.8.2 Lateral deflection**

Calculate the lateral deflection and the lateral set under each load for each deflection meter as the difference between the reading of the deflection meter when the load is applied and the initial reading. Calculate the lateral deflection and lateral set for the panel as the average of the lateral deflection and lateral set of the two deflection meters.

### **E.8.3 General**

Record the maximum load for each specimen and report the results of load-deformation and load-deflection measurements in the form of a graph.  
Report gauge lengths of all deflection or deformation gauges.

For extended application of the test results, the general rule is that test results for the most onerous assembly can be used to reflect the behaviour of other ones.

## **E.9 Test report**

The test report shall include the following information:

- a. reference to this EOTA ETA-Guideline, Annex E
- b. the name of the testing laboratory
- c. the name of the ETA-Applicant (and manufacturer of the composite panel)
- d. date of the test
- e. description of the test instruments
- f. identification of the product tested (designation, dimensions and any relevant identification characteristic)
- g. identification of the sample(-s) tested (dimensions, shape, etc.) and reference to its marking (if any)
- h. surface structure (e.g. smooth, profiled, structured, ...)
- i. description of conditioning and preparation of the sample (if any)
- j. the speed of applying the load
- k. description of test conditions (temperature and RH)
- l. results of the test (deflection and corresponding loads), including a description of damages during the test and the reason for terminating the test

## **ANNEX F**

### **DETERMINATION OF FLOOR SLIPPERINESS**

#### **F.1 Principle**

This test method provides means of classifying pedestrian floor finishes according to their frictional characteristics using the oil-wet ramp method.

Two test persons, wearing standard test shoes, are used to determine the angle of inclination at which safe walking no longer occurs, after the floor finishing being tested has been coated with engine lubricating oil. The test persons, each in turn, facing downhill and with upright posture, move backwards and forwards over the test surface, as they increase their angle of inclination, until the safe limit of walking is reached.

The angles of inclination obtained at such limits are used to assess the friction characteristics of the test surface. The mean acceptance angle obtained is used to assess the degree of slip resistance.

Subjective influences on the acceptance angle are limited by means of a calibration procedure.

Note: Test results based on this test method for any floor covering product cannot guarantee that persons/vehicles will not ever slip/skid on a given walkway, composed of that product.

#### **F.2 References**

These test methods are derived from the following reference documents:

DIN 51130:1992	Testing of floor coverings – Determination of the anti-slip properties – Workrooms and fields of activities with raised slip danger – Walking method – Ramp test
DIS ISO 10545-17	Ceramic Tiles – Part 17: Determination of coefficient of friction
AS/NSZ 4586:1999	Slip resistance classification of new pedestrian surface materials

#### **F.3 Definitions**

**Dynamic critical angle:** The dynamic critical angle is the angle at which slipping of a test subject occurs while walking on a lubricated inclined platform.

**Floor finishing (covering):** Top finishing layer of the floor system, intended to be walked upon.

**Friction:** Intrinsic property of the two interfacing, interacting surfaces resulting from their micro- and macro-roughness, inter- and intra-molecular forces of attraction and repulsion, and their visco-elastic properties.

**Slip resistance:** The relative force which resists the tendency of vehicles, the footwear or foot to slide along a surface. Slip resistance is related to a combination of factors, including the floor covering, the footwear and the presence of contaminants between them. For vehicles, the term skid resistance is often used.

**Slip resistive:** A surface is slip resistive if the available friction is sufficient to enable a person (or vehicle) to traverse that surface without an unreasonable risk of slipping.

#### **F.4 Apparatus**

##### **F.4.1 Test shoe**

The test persons wear test shoes, form ST, shoe design S1 in accordance with (?DIN 4843.100?) with an outsole on a nitrile rubber base, IRHD hardness  $73 \pm 5$  in accordance with EN ISO 868, with a profile as shown in figure H.1.

Note: Test shoes can be obtained from Saurefliesner-Vereinigung e.V., Im Langen Felde 4, D-30938 Burgwedel, Germany. Other sources (or even other shoes, might be possible).

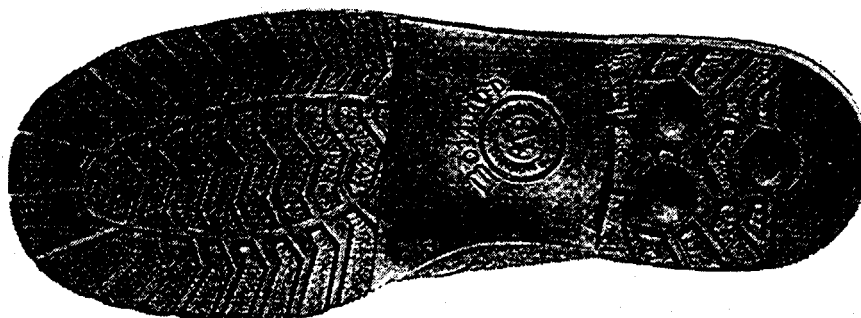


Figure F.1 - Outsole of test shoe

#### F.4.2 Inclined ramp

The test apparatus used (see figure F.2) is a flat torsion-resistant platform, typically 600 mm wide and 2000 mm long, the pitch of which can be adjusted in the longitudinal direction from 0° to 45°. The lifting movement may be continuous or controllable, in stages of 0,5°, by the test person. An angle measurement indicator fitted to the assembly shall have an accuracy of  $(0,5 \pm 0,2)^\circ$ . It shall not be visible to the test person.

Notes: 1) The apparatus should be capable of inclining at a rate of 1 °/s.  
2) A commercially available device can be obtained from Gabrielli SRL, PO Box 218, I-50019 Sesto Fiorentino, Firenze, Italy.

For the safety of the test persons, railings shall be fitted along the longitudinal sides of the test assembly. When walking on the ramp apparatus, the test person shall also be secured against falling by an appropriate safety device, which allows the test person to move naturally during the test.

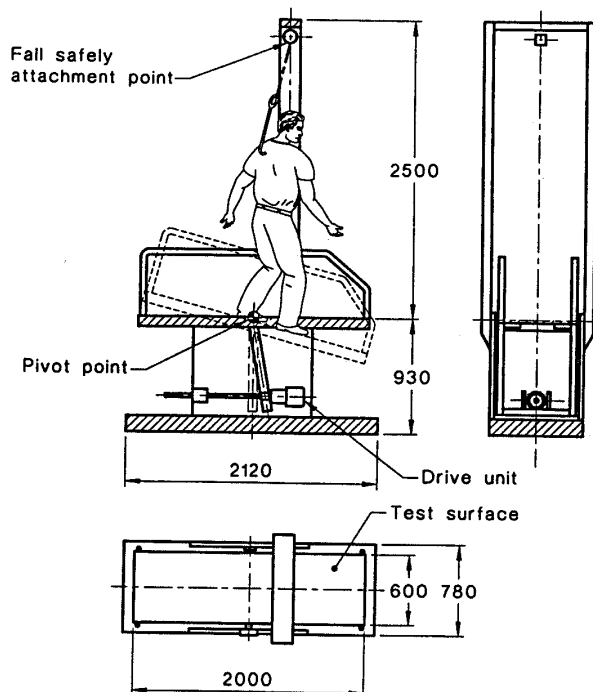


Figure F.2

Test assembly (ramp), with safety equipment (dimensions in mm) - from DIN 4843.100



### **F.4.3 Lubricants**

Engine lubricating oil of SAE viscosity class 10 W 30 is used for the tests. The oil shall be stored in a sealed container to prevent any change in viscosity.

### **F.4.4 Calibration boards**

Three calibration boards, E, P and R, are standardised test panels, the slip resistive properties of which have previously been assessed at angles of 10,7°, 18,2° and 26,8° respectively, in accordance with this test method.

Note: Calibration boards can be obtained from Saurefliesner-Vereinigung e.V., Im Langen Felde 4, D-30938 Burgwedel, Germany.

### **F.5 Test sample**

The test panel shall be approximately (1000 x 500) mm in size. It shall be made from the floor finishing to be tested, either as a whole unit cut from a larger sheet, or as an assembly of segmental units, such as individual tiles, or even the nosing sections cut from stair treads.

The pedestrian floor finishing to be tested shall either be self-supporting, or shall be manufactured to become self-supporting, warp-free slabs with level undersides, or shall be fixed to level base plates made of a load-bearing, warp-free material. The finishing to be tested shall be clearly identifiable or shall be marked as such.

Pedestrian floor finishes with directional profiles or roughness shall be positioned in such a way that the direction of minimum slip resistance corresponds to the direction of movement.

Segmental pedestrian floor finishes, which are rectangular in shape and without directional profiles or roughness, shall be positioned in such a way that the short edge is parallel to the rotary axis of the test apparatus.

The upper face of the test panels shall be cleaned as appropriate before testing, to remove any manufacturing residues, dirt, stripping agents or rough edges that would normally be removed prior to putting in service of the completed installation.

The test floor finishing shall be prepared from the floor finishing to be used in the same way as this type of covering is used in practice.

### **F.6 Test procedure**

#### **F.6.1 Basic walking procedure**

The temperature in the test area and the temperature of the shoe, lubricant and test surface shall be  $(23 \pm 5) ^\circ\text{C}$ .

Before testing starts,  $(100 \pm 1)$  ml of the lubricant shall be evenly spread over the surface of the test finishing using a paintbrush. The outsole of the shoe shall be moistened with the same lubricant using the paintbrush, at approximately the same spread rate.

The test person shall proceed with an upright posture facing downwards taking steps, half a shoe length, forwards and backwards on the test finishing. The pitch of the test finishing is increased from the horizontal at a rate of around 1 °/s. The angle of inclination at which the person reaches the threshold of safe walking (acceptance angle) is obtained by repeated travel up and down around the critical range. The acceptance angle of the test finishing is determined three times, each time starting from the horizontal. In each case, before the second and third measurements, the lubricant is once again spread evenly over the surface using the paintbrush.

The walking operation shall be carried out by two test persons.

## F.6.2 Calibration (selection and familiarisation of test persons)

The three standard floor finishes (E, P and R) shall be used for the calibration procedure. The acceptance angle ( $\alpha$ ) of these floor finishes is given in Table F.1 and is specified as standard acceptance angles  $\alpha_{S,E}$ ,  $\alpha_{S,P}$  and  $\alpha_{S,R}$ .

Standard floor finishing	$\alpha_{S,j}$ degree	$CrD_{95}$ degree
E	10,7	3,7
P	18,2	2,7
R	26,8	2,3

## F.6.3 Procedure

The procedure shall be as follows:

- On the same day, but prior to testing the test finishes (see §H.6.1), each test person ( $j$ ) walks on each standard floor finishing three times and the mean values  $\alpha_{K,E,j}$ ,  $\alpha_{K,P,j}$  and  $\alpha_{K,R,j}$  are determined.
- Each individual correction value  $D\alpha_{i,j} = \alpha_{S,i} - \alpha_{K,i,j}$  ( $i = E;P;R$ ) is calculated and gives  $\Delta\alpha_{E,j}$ ,  $\Delta\alpha_{P,j}$  and  $\Delta\alpha_{R,j}$ .
- Each of the individual correction values shall be less than the corresponding critical differences  $CrD_{95}$  that are given in table H.1, i.e.  $|\Delta\alpha_{i,j}| \geq CrD_{95}$ . If one of the absolute values is greater, the test person in question shall be excluded from the test. They shall be replaced by another test person for that day.

## F.6.4 Evaluation of test finishing

Each accepted test person ( $j$ ) walks on the test floor finishing three times and the mean value ( $\alpha_{0,j}$ ) is determined.

A correction value  $D_j$  is calculated for each test person. Depending on the size of the mean test acceptance angle ( $\alpha_{0,1}$  or  $\alpha_{0,2}$ ) obtained, the calculation is carried out in accordance with one of the four cases given in table F.2.

The individual result, the corrected mean acceptance angle ( $\alpha_j$ ), for each test person ( $j$ ) is the addition of correction value  $D_j$  to the mean test acceptance angle  $\alpha_{0,j}$  as follows:

$$\alpha_j = \alpha_{0,j} + D_j$$

Case	Correction value $D_j$ for test finishing
$\alpha_{0,j} < \alpha_{K,E,j}$	$D_j = \Delta\alpha_{E,j} \frac{1}{\sqrt{2}}$
$\alpha_{K,E,j} \leq \alpha_{0,j} < \alpha_{K,P,j}$	$D_j = \left[ \Delta\alpha_{E,j} + (\Delta\alpha_{P,j} - \Delta\alpha_{E,j}) \cdot \frac{\alpha_{0,j} - \alpha_{K,E,j}}{\alpha_{K,P,j} - \alpha_{K,E,j}} \right] \frac{1}{\sqrt{2}}$
$\alpha_{K,P,j} \leq \alpha_{0,j} < \alpha_{K,R,j}$	$D_j = \left[ \Delta\alpha_{P,j} + (\Delta\alpha_{R,j} - \Delta\alpha_{P,j}) \cdot \frac{\alpha_{0,j} - \alpha_{K,P,j}}{\alpha_{K,R,j} - \alpha_{K,P,j}} \right] \frac{1}{\sqrt{2}}$
$\alpha_{K,R,j} \leq \alpha_{0,j}$	$D_j = \Delta\alpha_{R,j} \neq \frac{1}{\sqrt{2}}$

## F.7 Expression of results

The corrected mean acceptance angles  $\alpha_1$  and  $\alpha_2$  are added together and divided by two. The final result of the test by two test persons is the corrected mean overall acceptance angle ( $\alpha_{ave}$ ).

This is used to assign the floor finishing to a slip resistance assessment group in accordance with table F.3.

For determining the slip resistance characteristics of floor finishes with directional surface profiles or texture, the direction with the lowest total acceptance angle shall be used for classification purposes.

<b>Corrected mean overall acceptance angle</b> <i><math>\alpha_{ave}</math></i>	<b>Slip resistance assessment group</b>
3° to 10°	R 9
over 10° to 19°	R 10
over 19° to 27°	R 11
over 27° to 35°	R 12
over 35°	R 13

## **F.8 Test report**

The test report shall include the following information:

- a. reference to this EOTA ETA-Guideline, Annex F
- b. the name of the testing laboratory
- c. the name of the ETA-Applicant (and manufacturer of the floor finishing)
- d. date of the test
- e. description of the test instruments, safety device, test shoe (brand, model, type of heel, outsole material) and the lubricants used
- f. identification of the product tested (designation, dimensions and any relevant identification characteristic)
- g. surface structure (e.g. smooth, profiled, structured, ...)
- h. identification of the sample(-s) tested (dimensions, shape, etc.) and reference to its marking (if any)
- i. identification of the test persons (age, weight, length)
- j. description of conditioning and preparation of the sample (if any)
- k. description of test conditions (temperature and RH)
- l. results of the test (mean overall acceptance angle, rounded off to nearest 0,1)
- m. slip resistance assessment group, in accordance with table F.3.

## **ANNEX G**

### **DETERMINATION OF DISPLACEMENT VOLUME**

#### **G.1 Principle**

This test method provides means of measuring the size of the displacement volume of pedestrian floor finishes that have a severely profiled or structured surface, as are commonly used in industrial work areas.

The displacement volume is determined by filling the open cavities beneath the true surface of the pedestrian floor finishing with a paste of known density. The volume is calculated from the mass difference before and after filling the cavities.

Note: The displacement volume should only be measured subject to requested slip resistance assessment group (see Annex H).

#### **G.2 References**

These test methods are derived from the following reference documents:

- |                  |  |
|------------------|--|
| DIN 51130:1992   | Testing of floor coverings – Determination of the anti-slip properties – Workrooms and fields of activities with raised slip danger – Walking method – Ramp test |
| AS/NSZ 4586:1999 | Slip resistance classification of new pedestrian surface materials   |

#### **G.3 Test apparatus**

The test apparatus shall comprise a base plate with a flat surface, an adjustable metal frame to hold the test piece, scales with error limits of 0,05 g and a measuring device to determine the density of the paste, e.g. dispersion adhesive used for the test.

#### **G.4 Test sample**

A piece of floor finishing measuring (100 x 100) mm shall be used as the test piece. The test piece shall be representative of the surface configuration of the floor finishing.

In the case of tiles or flags with an edge length less than 90 mm, the test piece shall be made up from individual tiles or flags. The tiles or flags shall be glued to a base plate, close to each other without a joint gap and cut down to a 100 cm<sup>2</sup> test surface.

#### **G.5 Determination of density of paste**

The density shall be determined in each case on two samples of the paste used for the test, before the start of series of experiments. For this purpose a specimen tube is filled with the paste, ensuring there are no bubbles. This is smoothed off level with the top of the tube. The filling density is determined from the mass difference between the filled and empty tube and the volume of the specimen tube, and this is given to two decimal places.

#### **G.6 Test procedure**

The test piece shall be laid with the profiled or structured side on the base plate. Adhesive tape shall be attached along the top of the four sides, level with the surface. The weight of the test piece shall then be determined to the nearest 0,1 g. The test piece shall then be placed back onto the base plate with the profiled or structured side downwards, and the metal frame adjusted around the edges of the test piece, ensuring the frame is flush with the base plate.

The test piece shall then be turned over, the displacement volume filled with the paste and levelled off smoothly at surface level. The second weighing is carried out once the frame has been removed. Filling, smoothing, frame removal and the second weighing shall all take place within one minute. The displacement volume shall be determined from the mass difference and the calculated density of the paste. The test shall be carried out on five test pieces for each profile or structure.

## G.7 Expression of results

The size of the displacement volume shall be calculated as the arithmetic mean of the five volume determinations and rounded off to 0,5 cm<sup>3</sup>/dm<sup>2</sup>. Assignment to one of the displacement volume assessment groups in table G.1 is based on the volume obtained.

<b>Table G.1</b>	
<b>Assessment of displacement volume assessment group to surface-related minimum volumes</b>	
Surface-related minimum displacement volume cm <sup>3</sup> /dm <sup>2</sup>	Displacement volume assessment group
4	V 4
6	V 6
8	V 8
10	V 10

Floor finishes, the displacement volume of which is more than 10 cm<sup>3</sup>/dm<sup>2</sup> due to their open structure (e.g. grids), are assessed as V 10, without measuring the displacement volume.

## G.8 Test report

The test report shall include the following information:

- a. reference to this EOTA ETA-Guideline, Annex G
- b. the name of the testing laboratory
- c. the name of the ETA-Applicant (and manufacturer of the floor finishing)
- d. date of the test
- e. description of the test instruments and the paste used
- f. identification of the product tested (designation, dimensions and any relevant identification characteristic)
- g. surface structure (e.g. smooth, profiled, structured, ...)
- h. identification of the sample(-s) tested (dimensions, shape, etc.) and reference to its marking (if any)
- i. description of conditioning and preparation of the sample (if any)
- j. description of test conditions (temperature and RH)
- k. results of the test (displacement volume, rounded off to the nearest 0,5 cm<sup>3</sup>/dm<sup>2</sup>)
- l. displacement volume assessment group, in accordance with table G.1.

# ANNEX H

## DETERMINATION OF THE SUSCEPTIBILITY TO THE GROWTH OF HARMFUL MICRO-ORGANISMS

### H.1 Principle

This test determines the susceptibility to the growth of (harmful) micro-organisms.

**Important note:** Although *Aspergillus Niger* used in this test is not normally considered a serious hazard to human beings, care should be taken in its handling. It is possible for an individual to be allergic to it. Surgical gloves may be worn to protect the hands, and care should be taken not to splash the suspension on other areas of the skin or on clothes.

It is also possible, during the incubation period, for a foreign fungi, present as an unintentional intruder, to develop; some of these fungi thus present as native to some testing locations, may be injurious to the human system. For this reason, there is a possibility that the specimen, after exposure, may be a hazard, and it should be handled with care.

The greatest danger is that small, dry, detached particles of a foreign fungi may become airborne and be carried into the lungs.

Detached portions of growth may be so small that no protection is offered by wearing a gauze mask, and only a special respirator for sub-micron particles is effective.

### H.2 References:

The test method is derived from the following reference document:

BS 5980:1980                      Specification for adhesives for use with ceramic tiles and mosaics

### H.3 Test apparatus and materials

#### H.3.1 Materials

- Potato dextrose agar, mixed and sterilised, approximately 400 ml per test.
- Actively growing culture of *Aspergillus Niger* (references<sup>1</sup> are ATCC 10575, DSM 2143, CBS 123.48, IMI 017454)

#### H.3.2 Test apparatus

The following apparatus is required, in addition to normal mycological apparatus.

- Incubator, capable of being controlled at  $(29 \pm 1)^\circ\text{C}$  and  $(90 \pm 5)\%$  RH.
- Glass Petri dishes, made from transparent plastics material, free from discoloration, weld lines and other defects liable to interfere with microbiological use, without sharp edges. The petri dishes shall be free from contamination by loose particles greater than  $100\ \mu\text{m}$  in diameter, as assessed by visual examination. In order to avoid contamination by micro-organisms, the Petri dishes shall be manufactured under aseptic conditions or subjected to terminal sterilization by gamma-irradiation. The dishes shall be supplied in sealed bags.

### H.4 Test sample

Three pieces of lining material (e.g. faces of composite panels), 25 mm x 25 mm, cut from the product.

### H.5 Procedure

Heat sterilise the test samples in separate closed glass Petri dishes at  $110\ ^\circ\text{C}$  for 2 h. Allow to cool.

Pour the molten potato dextrose agar around the test samples, taking care to prevent the medium from touching the top face, until the medium is level with the top face of the test sample. When the

---

<sup>1</sup> These references refer to national culture databases (ATCC - American Type Culture Collection, Manassas, Virginia, USA; CBS - Centraalbureau voor Schimmelcultures, Utrecht, The Netherlands; DSM - DSMZ-Deutsche Sammlung von Mikroorganismen und Zellkulturen GmbH, Braunschweig, Germany; IMI - Cabi Bioscience UK Centre, Egham). Other corresponding references exist.

medium has solidified, place the Petri dishes in the incubator at  $(29 \pm 1) ^\circ\text{C}$  for 24 h.

Inoculate two of the Petri dishes with the *Aspergillus Niger*, using four small pieces of inoculum evenly spaced on the medium around the test piece (see figure H.1). The third Petri dish is a control to check for contamination. Inoculation is performed by using a cork borer to remove 4 plugs from the Potato Dextrose Agar surrounding the test sample and is replaced with 4 plugs of the actively growing *Aspergillus niger*. The plate is then incubated at  $(29 \pm 1) ^\circ\text{C}$  for 14 days.

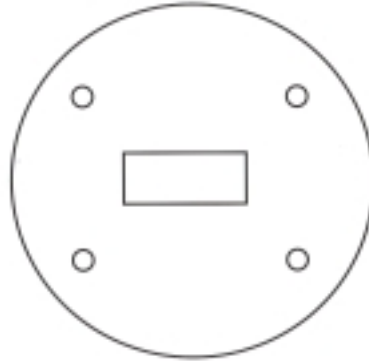


Figure H.1

## H.6 Expression of results

Examine all three Petri dishes for evidence of mould growth. A stereo microscope shall be used to see the hyphae on the test piece. Most of the time it can be seen with the naked eye. Record the extend of mould growth on the face material.

Repeat the test if:

- the control shows contamination
- the inoculum did not grow

If growth is detected on the sample, the result of the test is that the product is not resistant to mould growth.

## H.7 Test report

The test report shall include the following information:

- a. reference to this EOTA ETA-Guideline, Annex H
- b. the name of the testing laboratory
- c. the name of the ETA-Applicant (and manufacturer of the composite panel)
- d. date of the test
- e. description of the test instruments
- f. identification of the product tested (designation, dimensions and any relevant
- g. identification characteristic)
- h. surface structure (e.g. smooth, profiled, structured, ...)
- i. identification of the sample(-s) tested (dimensions, shape, etc.) and reference to its marking (if any)
- j. description of conditioning and preparation of the sample (if any)
- k. description of test conditions (temperature and RH)
- l. results of the test, including a description of damage (if any)

# ANNEX I

## DETERMINATION OF RESISTANCE TO ROLLING LOAD

### I.0 General

This annex consists of 4 test methods, all of which are required to obtain a classification for resistance to rolling loads.

### I.1 Resistance to impact

#### I.1.1 Principle

This test determines the resistance of floor panels to impact.

#### I.1.2 References:

The test method is derived from the following reference document:  
Revêtement de sol industriels - Classement performantiel - Référentiel Technique  
(Cahier 3232 du CSTB, Livraison 410, 2000-06)

The following standards are referred to:  
EN 1323:1999                      Adhesives for tiles - Concrete slab for test

#### I.1.3 Test apparatus and materials

- a sand bed, which permits supporting a sample of 40 cm x 40 cm
- a vertical support that disposes of a provision to retain the ball until its fall is initiated and which can be moved vertically on the support.
- a polished steel ball with a mass of  $(250 \pm 10)$  g
- a polished steel ball with a mass of  $(514 \pm 14)$  g

#### I.1.4 Test samples

The test samples are made on the concrete support or on the floor panels which are part of the kit. Three samples of (at least) 0,16 m<sup>2</sup> should be subjected to the test. The concrete support will be prepared in accordance with EN 1323.

#### I.1.5 Test procedure

The test samples are positioned on the bed of sand, so that the test sample surface is horizontal. The ball is released from the retaining provision, from the required height, on the sample. The impact should be located within 2 cm of the centre of the sample. To prevent the ball from falling onto the sample again, it should be caught when it rebounds.

Depending on the intended use claimed, either of the balls (or both) as specified in §I.1.3 should be used and the test should be performed once or repeatedly on the same sample (see I.1.6).

#### I.1.6 Expression of results

The inspection of the sample takes place with the naked eye. Coloured marking can be used to visualise possible deteriorations.

The degradation of the surface of the sample shall be registered as indicated in table I.1.1 and classified in accordance with table I.1.2.



**Table I.1.1: Observations and corresponding degradation level.**

Degradation level	Observations
0	No traces surrounding the impact of the ball
1	circular traces surrounding the impact of the ball, no radial fissures, no parts coming loose
2	radial fissures with a length (l) smaller or equal to 5 mm, no parts coming loose
3	radial fissures with a length (l) larger than 5 mm or parts coming loose

**Table I.1.2 : Classification for resistance to impact**

Classification	Maximum degradation level*	Test specification		
		Number of impacts	Weight ball (g)	Height of drop (cm)
I <sub>1</sub>	2	1	510	80
I <sub>2</sub>	2	1	510	80
	1	10	250	100
I <sub>3</sub>	1	10	510	100
	0	1	510	80
I <sub>4</sub>	0	20	510	100

\* If more than one maximum degradation level is indicated, the product has to meet both requirements in order to be obtain the corresponding classification.

### **I.1.7 Test report**

The test report shall include the following information:

- a. reference to this EOTA ETA-Guideline, Annex I.1
- b. the name of the testing laboratory
- c. the name of the ETA-Applicant (and manufacturer of the composite panel and/or floor covering)
- d. date of the test
- e. description of the test instruments
- f. identification of the product tested (designation, dimensions and any relevant identification characteristic)
- g. surface structure (e.g. smooth, profiled, structured, ...)
- h. identification of the sample(-s) tested (dimensions, shape, etc.) and reference to its marking (if any)
- i. description of conditioning and preparation of the sample (if any)
- j. description of the test (the mass of the ball(-s) used, the release height)
- k. description of test conditions (temperature and RH)
- l. results of the test, including a description of damages (if any) and the classification

## **I.2 Resistance to perforation**

### **I.2.1 Principle**

This Annex specifies 2 test methods to determine the resistance of floor panels to (static) perforation. Depending on the kind of floor covering (hard or resilient), an additional test, performed in accordance with EN 433, might be necessary in order to classify the product concerned.

### **I.2.2 References:**

The test method is derived from the following reference document:  
Revêtement de sol industriels - Classement performantiel - Référentiel Technique  
(Cahier 3232 du CSTB, Livraison 410, 2000-06)

The following standards are referred to:

- |                 |   |
|-----------------|---|
| EN 433:1994     | Resilient floor coverings - Determination of residual indentation after static loading                |
| EN ISO 868:1998 | Plastics and ebonite - Determination of indentation hardness by means of a durometer (Shore hardness) |

### **I.2.3 Shore hardness**

The test is performed in accordance with EN ISO 868, with the following specifications:

- Mass applied:  $(1000 \pm 10)$  g
- Contact period:  $(15 \pm 1)$  s

The test results are expressed as specified in the standard.

### **I.2.4 "Ball" hardness**

#### **I.2.4.1 Test apparatus and materials**

A durometer (type Zwick) or equivalent, equipped with a steel ball with a diameter of 10mm, under the following conditions:

- A reception platform, upon which the test sample is positioned, in the axis of the ball
- A conditioning load of  $(1000 \pm 10)$  g, applied during  $(30 \pm 1)$  s
- A load of  $(50 \pm 1)$  kg, applied during  $(120 \pm 10)$  s

#### **I.2.4.2 Test samples**

Depending on the floor covering, the following test samples are prepared:

- Floor coverings with a nominal thickness smaller than 10 mm, are tested adhering to a support, with a hardness that is similar to that of concrete (about  $6,3 \text{ kg/mm}^2$ )

Note: For example a fibre-cement panel with a thickness of 7,5 mm and density of  $1\,600 \text{ kg/m}^3$

- For floor coverings with a nominal thickness equal to or larger than 10 mm, 4 samples of  $0,16 \text{ m}^2$  are prepared and stored in laboratory conditions, so that the product is allowed to harden, during the time period as specified by the ETA-applicant.

8 test samples with minimal dimensions 10 cm x 10 cm are subjected to the test.

#### **I.2.4.3 Test procedure**

The test samples are conditioned during 14 days in laboratory conditions. Measuring the hardness is performed in the centre of the samples.

The depth of the impression of the ball is given by the following equation:

$$h = e_1 - e_0$$

With:

$e_0$  The zero value, which is inherent to the instrument. It is obtained by performing the test onto the platform.

$e_1$  The depth of the impression as given by the instrument.

The hardness is calculated in accordance with the following equation:

$$dur = \frac{50 \times 9,81}{\pi \cdot d \cdot h}$$

With:

$dur$  The hardness (in N/mm<sup>2</sup>)

$d$  Diameter of the ball (mm)

### I.2.5 Expression of results of the various test methods

The product shall be classified as indicated in table I.2.1 or I.2.2.

**Table I.2.1: Classification for resistance to perforation for hard floor coverings**

Classification	Shore A hardness	"Ball" hardness (N/mm <sup>2</sup> )
P <sub>1</sub>	≥ 95	≥ 30
P <sub>2</sub>		≥ 30
P <sub>3</sub>		≥ 80
P <sub>4</sub>		≥ 150

**Table I.2.2: Classification for resistance to perforation for resilient floor coverings**

Classification	Shore A hardness	Residual indentation, cf. EN 433 (mm)
P <sub>1</sub>	≥ 85	≥ 0,10
P <sub>2</sub>	≥ 90	
P <sub>3</sub>	≥ 95	
P <sub>4</sub>		

### I.2.6 Test report

The test report shall include the following information:

- a) reference to this EOTA ETA-Guideline, Annex I.2
- b) the name of the testing laboratory
- c) the name of the ETA-Applicant (and manufacturer of the composite panel)
- d) date of the test
- e) description of the test instruments
- f) identification of the product tested (designation, dimensions and any relevant identification characteristic)
- g) surface structure (e.g. smooth, profiled, structured, ...)
- h) identification of the sample(-s) tested (dimensions, shape, etc.) and reference to its marking (if any)
- i) description of conditioning and preparation of the sample (if any)
- j) description of test conditions (temperature and RH)
- k) classification based on the respective tests

## **I.3 Skid resistance**

### **I.3.1 Principle**

This test determines the resistance of floor panels to skid.

### **I.3.2 References:**

The test method is derived from the following reference document:  
Revêtement de sol industriels - Classement performantiel - Référentiel Technique  
(Cahier 3232 du CSTB, Livraison 410, 2000-06)

### **I.3.3 Test apparatus and materials**

- Supporting platform:
  - The platform turns in a horizontal plane, with a speed of  $(60 \pm 2)$  rpm.
  - The platform is powered by an electrical motor, ensuring that the speed does not drop during the test
  - The platform surface is continuous and perpendicular to the axis of the motor.
- Registration device that measures the revolutions
- Skid dihedral (angle): A steel dihedral, with the following specifications:
  - Steel quality 1.4301 (X5CrNi18-10) in accordance with EN 10088-2.
  - Thickness:  $(3,0 \pm 0,1)$  mm
  - Angle:  $(120 \pm 1)^\circ$
  - Width:  $(65 \pm 1)$  mmThe dihedral is checked and, if necessary, fixed, after each test, so that an angle of  $120^\circ$  is retained. Every play should be prevented to prevent vibrations.
- Vertical axis:
  - Perpendicular to the supporting platform
  - intended to support the test sample, upon which the skid dihedral is fixed
  - supporting a variable load of 5 to 30 kg, by steps of 5 kg.
  - The distance between the axis of the platform and the one that supports the skid dihedral shall be  $(100 \pm 2)$  mm.

### **I.3.4 Test samples**

The test samples are made on the concrete support or on the floor panels which are part of the kit. Three samples of (at least)  $0,16 \text{ m}^2$  should be subjected to the test. The concrete support will be prepared in accordance with EN 1323.

### **I.3.5 Test procedure**

The sample shall be placed onto the supporting platform and the skid dihedral installed. Apply the load in accordance with the intended use claimed (see I.3.6). Programme the duration and/or the number of revolutions foreseen.

### **I.3.6 Expression of results**

The test sample should be stored, so that it can cool down. With the naked eye, the level of degradation should be registered, so that the product can be classified as indicated in table I.3.1.

**Table I.3.1: Classification for resistance to skid**

<b>Classification</b>	<b>No degradation or only a scratch, without material coming loose after 30s under the load (kg) as indicated and no other relevant degradation</b>
S <sub>1</sub>	5
S <sub>2</sub>	10
S <sub>3</sub>	15
S <sub>4</sub>	30

### **I.3.7 Test report**

The test report shall include the following information:

- a. reference to this EOTA ETA-Guideline, Annex I.3
- b. the name of the testing laboratory
- c. the name of the ETA-Applicant (and manufacturer of the composite panel)
- d. date of the test
- e. description of the test instruments
- f. identification of the product tested (designation, dimensions and any relevant identification characteristic)
- g. surface structure (e.g. smooth, profiled, structured, ...)
- h. identification of the sample(-s) tested (dimensions, shape, etc.) and reference to its marking (if any)
- i. description of conditioning and preparation of the sample (if any)
- j. description of test conditions (temperature and RH)
- k. results of the test, including a description of damages (if any) and the classification.

## I.4 Resistance to abrasion

### I.4.1 Principle

This test determines the resistance of floor panels to abrasion.

### I.4.2 References:

The test method is derived from the following reference document:  
Revêtement de sol industriels - Classement performantiel - Référentiel Technique  
(Cahier 3232 du CSTB, Livraison 410, 2000-06)

The following standards are referred to:

EN 1323:1999 Adhesives for tiles - Concrete slab for test

### I.4.3 Test apparatus and materials

#### I.4.3.1 Supporting platform

The platform turns in a horizontal plane with a speed of  $(93 \pm 2)$  rpm. The platform is powered by an electronic motor, with sufficient power to prevent the speed from decreasing during the test. The platform surface is continuous and perpendicular to the axis that powers the platform.

#### I.4.3.2 Electrical motor

A motor which permits to power the supporting platform, with a minimum power of 1 CV

#### I.4.3.3 Programmable speed variator

A speed variator, capable of operating the motor, with a minimum power of 1 kW, in accordance with the following figure I.4.1

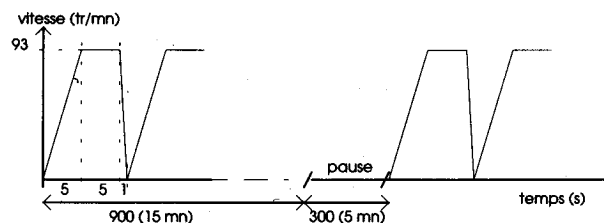


Figure I.4.1: Speed variations

#### I.4.3.4 Timing device

A device permitting the test to be concluded automatically after a total period of 4 hours.

#### I.4.3.5 Small wheel

A steel wheel, solid and chamfered, with the following characteristics:

- low carbon austenitic stainless steel, type 1.4301 (X5CrNi18-10) in accordance with EN 10088-2
- diameter:  $50 \pm 0$
- width of the wheel, without chamfers:  $25 \pm 0$
- free, both in rotation, as in direction
- powered by the rotation of the platform
- the wheel is replaced when the measured diameter in the middle of the wheel band approaches 49 mm.

#### I.4.3.6 Vertical axis

The axis is perpendicular to the platform, destined to receive the tread on which the wheel is fixed. The axis supports a load, which may be variable, function of the severity of the test. The distance between the axis of the platform and the one supporting the wheel is  $(100 \pm 2)$  mm. The casing which holds the axis, supporting the wheel, should be such that every play is prevented. The same applies to the mechanical parts supporting the casing, to prevent vibrations.

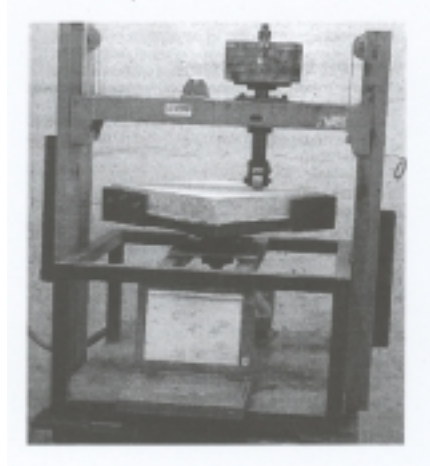


Figure I.4.2, example of a test set-up.

#### I.4.4 Test samples

The test samples are made on the concrete support or on the floor panels which are part of the kit. Three samples (at least) of  $0,16 \text{ m}^2$  should be subjected to the test. The concrete support will be prepared in accordance with EN 1323.

#### I.4.5 Test procedure

Clean the surface of the test samples with compressed air.

##### I.4.5.1 Determination of loss of mass, linked to abrasion

- Weigh the mass  $m_0$  of the test sample, to the gram.
- Place the sample onto the platform, drop the wheel onto the sample and apply the load. Programme the test for a duration of  $(240 \pm 1)$  min.
- At the end of the test, withdraw the provision holding the wheel completely and remove the sample. Let it cool down.
- Clean the surface of the test samples with compressed air again, starting from the middle to the outside.
- Condition the sample at least 24h in the measuring atmosphere, i.e.  $(23 \pm 2) \text{ }^\circ\text{C}$  and  $(50 \pm 5) \text{ \%RH}$ .
- Weigh the mass  $m_1$  of the test sample, to the gram.
- Determine the loss of weight for each sample ( $m_1 - m_0$ ).

##### I.4.5.2 Determination of loss of volume, linked to abrasion

- Fill the deformation with paraffin. Even out the deformation zone to prevent the paraffin from indicating more than the abrasion zone. Let the paraffin cool down.
- Weigh the mass  $m_2$  of the test sample, to the gram.
- Determine  $m_p$ , the weight of the deposited paraffin ( $m_2 - m_1$ ).
- Determine the density of the paraffin,  $\rho_p$ .
- Calculate for each sample the loss of volume, through the following equation:

$$\Delta v_r = m_p / \rho_p.$$

I.4.5.3 Determination of relative loss of volume, linked to abrasion (Special cases, with floor coverings with particularly uneven surfaces)

Determine the surface of the deformation as follows:

- Divide the surface into 8 identical sectors (see figure I.4.3).
- Determine diameter,  $d$ , by calculating the mean of 4 exterior diameters  $d_1$  to  $d_4$ , as given in figure I.4.3.
- Determine diameter,  $d'$ , by calculating the mean of 4 interior diameters  $d'_1$  to  $d'_4$ , as given in figure I.4.3.
- Determine the abraded surface, through the following equation:

$$S = \pi \times (d^2 - d'^2) / 4$$

Determine the volume ( $V_s$ ) of paraffin by tracing the limits of a surface identical to that corresponding to the abraded area ( $S$ ) and by depositing the paraffin there as indicated in I.4.5.2.

The loss of relative volume linked to the abrasion is then calculated through:

$$V_a = \Delta v_r - V_s$$

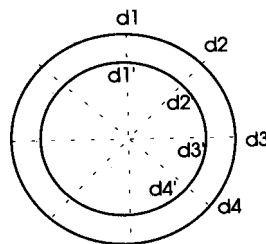


Figure I.4.3, division of the test sample surface into 8 sectors.

I.4.6 Expression of results

The following shall be registered:

- the applied load
- the loss of mass or the deposited mass for each of the test samples
- the loss of volume or the deposited volume for each of the test samples
- the mean characteristic loss of volume of the floor covering
- the abrasion rate is expressed in  $\text{cm}^3/\text{cm}$

The product shall be classified as indicated in table I.4.1

Table I.4.1: Classification for abrasion resistance

Classification	Applied loading (kg) at which the loss of volume ( $\Delta v_r$ ) was smaller than $2\text{cm}^3$
A <sub>1</sub>	15
A <sub>2</sub>	30
A <sub>3</sub>	45
A <sub>4</sub>	60

I.4.7 Test report

The test report shall include the following information:

- a. reference to this EOTA ETA-Guideline, Annex I.4
- b. the name of the testing laboratory
- c. the name of the ETA-Applicant (and manufacturer of the composite panel)
- d. date of the test
- e. description of the test instruments
- f. identification of the product tested (designation, dimensions and any relevant identification characteristic)
- g. surface structure (e.g. smooth, profiled, structured, ...)
- h. identification of the sample(-s) tested (dimensions, shape, etc.) and reference to its marking (if



- any)
- i. description of conditioning and preparation of the sample (if any)
  - j. the applied load
  - k. description of test conditions (temperature and RH)
  - l. results of the test, including a description of damages (if any) and the classification.

## ANNEX J

### RECOMMENDED CHECKLIST FOR INITIAL INSPECTION OF FACTORY AND OF FACTORY PRODUCTION CONTROL AND FOR THE CONTINUOUS SURVEILLANCE OF FACTORY PRODUCTION CONTROL

The purpose of this checklist is primarily to assist those involved in the implementation of the technical specification in the sector groups. The checklist is a recommendation for use by the notified bodies and not legally binding. It complies with the provisions of the CPD and of Guidance Papers 'B' and 'K', The checklist is intended for initial inspection and the continuous surveillance only,

#### **Initial inspection of the factory and factory production control (FPC)**

The initial inspection of the factory provides for the identification and documentation of the kind and manner of the manufacturing process and factory production control of the products. This is to enable the notified body/inspection body to assess the compliance with the provisions of the technical specification on the one hand and to provide a baseline to identify possible changes that may occur during surveillance.

#### **Surveillance of factory production control (FPC)**

The surveillance of the manufacturing process includes checking the documentation of the factory production control to ensure continuing compliance with the provisions of the technical specification, and the identification of changes by comparing data obtained during the initial inspection or during the latest inspection.

In the course of the initial inspection the following criteria should be considered:

Notes:

- The text in *italics* is for Continuous surveillance only.
- Crosses ("x") indicate which questions should be asked during either Initial inspection or Continuous Surveillance, or both.

<b>Questions to be considered</b>		<i>Initial inspection</i>	<i>Continuous Surveillance</i>
01	For which types of cold storage room kits has a factory production control been established ?	x	x
02	Has an ETA been issued for the cold storage room kits ?	x	
03	Has the Approval testing been validated as Initial Type Testing ?	x	
04	Does the ETA-holder apply a quality management system related to the technical specification and if so, is that proved by a valid certificate and by whom ?	x	
05	Does the factory production control for the products to be certified form part of the quality management system ?	x	
06	Does the ETA-holder still apply a quality management system that covers the factory production control of the certified products, and is there a valid certificate?		x
07	Has the production and/or the ETA changed since the last continuous surveillance ? If yes, has the ETA-holder adapted the documentation accordingly ?		x
08	Does the ETA-holder have direct control of the appropriate machinery for the production of the products to be certified, or are key elements of the production with respect to the essential characteristics subcontracted to others on or off the site ?	x	
09	Is the maintenance of machinery and measuring equipment carried out properly, regularly, and is this documented and is the documentation up to date ( <i>as before</i> ) ?	x	x

Questions to be considered		Initial inspection	Continuous Surveillance
10	Are the personnel involved in the production sufficiently qualified and trained to operate and maintain the production equipment ( <i>as before</i> ) ?	x	x
11	Have the personnel involved in the production been identified ?	x	
12	Have there been alterations in the personnel involved in the production since the initial or the last continuous surveillance?		x
13	Are all processes and procedures of the production recorded at regular intervals or continuously (automatically) ( <i>as before</i> )	x	x
14	How is the documentation organised?	x	
15	Have there been changes in the manner of recording or documentation since the initial or the last continuous surveillance?		x
16	For the products to be certified, does the ETA-holder have a system to document the production process from purchasing/delivery of the basic materials through to the storage and the delivery of the finished products ( <i>as before</i> ) ?	x	x
17	Has traceability of kit components and constituents been assured ( <i>as before</i> ) ?	x	x
18	Is an inspection of the incoming material carried out ( <i>as before</i> ), and if yes, how and at what intervals ?	x	x
19	Have the provisions for procurement of the basic materials and/or the suppliers been changed ?		x
20	Is there a certificate for raw materials or components that are being certified on a voluntary basis and are the inspection/laboratory reports available ( <i>as before</i> ) ?	x	x
21	Which characteristics of the products are tested and recorded in the course of the production process and/or on the final products or documented in any other manner ?	x	
22	Is the manner, extent and frequency of factory production control in accordance with the provisions of the ETA and the documented system ?	x	
23	What are the test methods and equipment used ?	x	
24	If proxy values of characteristics are being used, have appropriate measurements been performed and documented linking the test methods and equipment used with the technical specification?	x	
25	Is the manner, extent and frequency of factory production control still in accordance with the provisions of the ETA ?		x
26	Have any changes been made concerning test methods and/or testing equipment ? If so, have appropriate comparable measurements been performed and documented ?		x
27	Do the findings of these tests ( <i>still</i> ) correlate with the requirements laid down in the technical specification for initial type testing, and for testing for surveillance purposes of the FPC?	x	x
28	Is the testing equipment correctly maintained and calibrated on a continuous basis ( <i>as before</i> ) to ensure consistent accuracy of the tests performed during factory production control and its surveillance?	x	x

<b>Questions to be considered</b>		<b><i>Initial inspection</i></b>	<b><i>Continuous Surveillance</i></b>
29	Does the ETA-holder apply ( <i>as before</i> ) an adequate documented system that allows the detection of defects and deviations quickly enough to identify unambiguously those products that are not in accordance with the product specification so that they are removed prior to delivery?	x	x
30	In which way is the marking of such products performed?	x	
31	For the products to be certified, does the ETA-holder apply an adequate documented system concerning product complaints received, and is it integrated into the factory production control ( <i>as before</i> ) ?	x	x
32	Does the system include appropriate measures to avoid or correct these deficiencies and are these being documented ( <i>as before</i> ) ?	x	x
33	How many complaints have been documented since the last surveillance period ?		x
34	Is there a documented system that is used where by the ETA-holder promptly informs the certification body / inspection body about all complaints ?	x	
35	Have complaints received by the ETA-holder been reported to their full extent to the certification body ?		x
36	Are the products duly marked with the CE marking ?		x
37	Are the provisions of EC Guidance Paper D being taken into account ?	x	x
38	Do the values measured during factory production control correspond with those values determined on products within the initial type testing by the notified body or validated approval testing under the responsibility of the approval body ?		x
39	Summary of the results by the inspection body and the specification of the measures to be taken for correction if necessary	x	x

## ANNEX K

### EXTENDED APPLICATION OF RESULTS FROM FIRE RESISTANCE TESTS FOR COLD STORAGE ROOM WALLS (MADE OUT OF COMPOSITE PANELS)

#### K.1. Scope

This annex provides guidance and, where appropriate, defines procedures for variations of certain parameters and factors associated with the design of internal and external non-loadbearing walls constructed of composite panels and that have been tested in accordance with EN 1364-1.

#### K.2. References

This annex references the following additional normative documents:

EN 1363-1	Fire resistance tests - Part 1: General Requirements
EN 1363-2	Fire resistance tests - Part 2: Alternative and additional procedures
EN 1364-1	Fire resistance tests for non-loadbearing elements - Part 1: Non-loadbearing walls
EN 1991-1-2	Eurocode 1: Actions on structures - Part 1-2: General actions - Actions on structures exposed to fire
EN 1993-1-2	Eurocode 3: Design of steel structures - Part 1-2: General rules - Structural fire design

#### K.3. Definitions, symbols and abbreviations

##### K.3.1 Definitions

###### **Classification**

The process defined in EN 13501, whereby the fire performance parameters obtained from the results of one test, or a set of tests, or from a process of extended application, are compared with limiting values for those parameters that are set as criteria for achieving a certain classification. The relevant classes and related criteria for fire resistance, for reaction to fire and for external fire exposure to roofs, are specified in Commission Decisions (2000/367/EC, 2000/147/EC and 2001/671/EC respectively).

###### **Constructional parameter**

An aspect of the reference specimen that varies for the purpose of the EXAP (other needs in practice) and may change of the fire resistance performance

###### **Direct field of application of test results**

The outcome of a process (involving the application of defined rules), whereby a test result is deemed to be equally valid for variations in one or more of the product properties and/or intended end use application(s).

###### **Extended field of application of test results**

The outcome of a process (involving the application of defined rules that may incorporate calculation procedures) that predicts, for a variation of a product property and/or its intended end use application(s), a test result on the basis of one or more test results to the same test standard.

###### **Factor**

One of the possible variations that may be applied to a parameter.

###### **Factor influence**

One of the potential causes of a change in the fire resistance due to a factor.

###### **Reference scenario**

All the fire test conditions and constructional details of the test specimen for which observations of fire behaviour, changes in temperatures, dimensions, displacement in the test specimen are given in the test report.

### **Reference test**

Tested construction for which an extended application is made.

### **Test result**

The outcome of a testing process and its associated procedures detailed within a specific test standard (which may include some processing of the results from the testing of a number of specimens). A test result is expressed in terms of one or more fire performance parameter(s).

## **K.3.2 Symbols**

- $\Delta f$  The deflection difference at midspan between the joint and the centers of the adjoining panels during the reference test
- $\Delta c$  The opening up of the joint at midspan between the joint and the centers of the adjoining panels during the reference test

## **K.4. Establishing the field of extended application**

### **K.4.1. Assumptions in the extended application**

- The panels are required to possess fire resistance in the end-use condition. Such requirements are given in national regulations and codes and may range from 15 minutes up to 4 hours
- The assembly of panels is assumed to be exposed on the entire face of one side to the standardised heating conditions given in the EN 1363-1 fire resistance test specification
- The structure above and below the panel assembly does not deflect vertically during the fire exposure period. This simulates the non-deflecting nature of the wall frame which forms part of the furnace test apparatus.
- After delamination of the fire exposed facing the dead load of the panel assembly is carried by a support structure to which the ends of the panels are attached: the panel assembly is then acting as a catenary construction.
- The support structure has at least the same fire resistance as the panel assembly.
- The self weight of the facing and core is calculated from information on the volume and density of the materials. The density of steel sheet can be assumed to be 7850 kg/m<sup>3</sup>. The density of the core material at elevated temperature should be assumed to be the density at room temperature unless there are appropriate data available on the time-dependant change in density due to the effects of fire exposure e.g. due to charring or significant reduction in moisture content.
- The reduction in the strength properties of steel at elevated temperature may be assumed to vary according to the relevant Eurocode. Information in EN 1993-1-2 and EN 1991-1-2 may be used.

### **K.4.2. Assumed structural behaviour of a composite panel in fire**

When one face of a composite panel assembly is exposed to fire the following behaviour can be expected:

The panel initially bows towards the fire and the ends of the panel may move because of expansion of the fire-exposed face. When delamination of the fire-exposed face occurs, the flexural strength of the assembly is lost and, unless both faces are restrained at the ends, the panels may collapse. The fastenings for the ends of the fire-exposed face have to support the dead load of that face whereas the fastenings for the ends of the unexposed face have to support the combined dead load of the face and the core for the entire fire resistance period.

## **K.5. Rules for extended applications of the tested product**

### **K.5.1. General**

When considering extended applications for a tested composite panel assembly, changes can occur either in the materials and/or in the construction. Both are being dealt with in this annex. The following table provides guidance on which changes can or cannot be made in an extended application assessment. The rules for the changes are given in K.5.2 and K.5.3.

**Table K.1: Acceptability of material changes for extended application**

Parameter	Factors	Factor influence on criteria		Rules
		Integrity	Insulation	
Changes in faces	Chemical composition of coating	X; big influence for E-classification only	V/X ; minor influence	5.2.2.1
	Change from coated to non coated faces	N ; no influence	X ; big impact	Not allowed without evidence. 5.2.2.1
	Face thickness	V/X ; minor influence	N ; no influence	5.2.2.2
	Change from one face material to another	U ; no information	U ; no information	Not allowed
	Change in face geometry	U	U	Not allowed. Minor changes, 5.2.2.3
Changes in adhesive	Amount	N; no influence	N; no influence	5.2.3
	Type	V/X; minor influence	N; no influence	5.2.3
Changes in core material	Type	V/X; big influence	V/X; big influence	Not allowed. 5.2.4
	Change in composition for mineral wools	V/X ; big influence	V/X ; big influence	5.2.4.2 5.2.4.3
	Change in composition for plastics	V/X ; big influence	V/X ; big influence	Not allowed. 5.2.4.4 - 5.2.4.7
<p>The qualitative factor influences are identified as follows:</p> <p>N: not relevant for or no influence on the fire resistance EI</p> <p>V: the change of the factor will result in an increase of the fire resistance EI</p> <p>X: the change of the factor will result in a decrease of the fire resistance EI</p> <p>U: the influence of the change of the factor can not be identified without additional fire tests or calculations.</p> <p>Where appropriate, the logic behind these judgements is given as well as their limits.</p>				

**Table K.2: Acceptability of constructional changes for extended application**

Parameter	Factors	Factor influence on criteria		Rules
		Integrity	Insulation	
Span length	Decrease	N ; no influence	N ; no influence	Always valid
	Increase	X ; minor influence -	N ; no influence	5.3.1
Orientation	Vertical to horizontal	V/X ; minor influence	N ; no influence	5.3.2
	Horizontal to vertical	V/X ; minor influence	N ; no influence	5.3.2
Panel width	Decrease	N ; no influence	N ; no influence	5.3.3
	Increase	X ; minor influence	N ; no influence	5.3.3
Panel thickness e.g. core thickness	Decrease	U	X ; big influence	Not allowed. Interpolation allowed, 5.3.4
	Increase	U	V ; big influence	Valid or interpolation, 5.3.4
Joint construction	Type	U ; big influence	U ; minor influence	Not allowed. Minor changes, 5.3.5
	Fixings decreased	X ; big influence	N ; no influence	Not allowed, 5.3.5
	Fixings increased	V ; minor influence +	N ; no influence	Valid, 5.3.5
Fixing system	Type	U ; big influence	N ; no influence	Not allowed. Minor changes, 5.3.6
	Amount decreased	X ; big influence	N ; no influence	Not allowed, 5.3.6
	Amount increased	V ; minor influence	N ; no influence	Valid, 5.3.6
	Protection decreased	X ; big influence	X ; minor influence	Not allowed
	Protection increased	V ; minor influence	V ; minor influence	Valid, 5.3.6
Length of assembly	Vertical installation	N ; no influence	N ; no influence	Valid, 5.3.7
	Horizontal installation			See span length
Height of assembly	Vertical installation			See span length
	Horizontal installation	N ; no influence	N ; no influence	Valid, 5.3.7
Supporting construction	Changes	U	N ; no influence	5.5
The qualitative factor influences are identified as follows: N: not relevant for or no influence on the fire resistance EI V: the change of the factor will result in an increase of the fire resistance EI X: the change of the factor will result in a decrease of the fire resistance EI U: the influence of the change of the factor can not be identified without additional fire tests or calculations. Where appropriate, the logic behind these judgements is given as well as their limits.				

## **K.5.2. Variations in the materials of the product**

### **K.5.2.1. General**

Normally a composite panel consists of three main materials (faces, adhesive and core material). In auto-adhesively bonded panels the foamed core material provides the adhesive layer in the foaming process. For these panels the chapter 5.2.3 is not valid.

Changes in the properties of the faces will not affect the fire resistance results very much and even rather big changes can therefore be allowed. On the other hand even small changes in the core material can give arise to big variations in the fire resistance results. These facts have been taken into account in the following rules.

### **K.5.2.2. Variations in the face materials**

#### **K.5.2.2.1. Variations in the coatings**

The most essential property of the coating regarding fire resistance is the emissivity. Normally the emissivity for a coated steel sheet is between 0,8 and 0,95. A change in emissivity of -10 % for another coating compared to the one tested is thus allowed, if there is at least a 10 % margin in the insulation test result compared to the I-classification. Test results are always valid for coatings with higher emissivity values compared to the tested one. When a change in coating is made the supplier of the coated face shall provide emissivity properties for the products.

A change from a coated to a non coated face is normally not allowed (a non coated metal sheet



can have an emissivity as low as 0,1). The same rule as for coatings above can apply also in this case. A change in emissivity of –10 % is allowed, if the emissivities for the different faces are known.

For bigger changes in emissivity surface temperatures can be estimated from small scale tests where the surface temperatures of the new panel is compared to the one tested in the reference scenario. If appropriate calculation methods are available the surface temperatures can also be calculated and compared provided that temperature dependent thermal resistance values for the core material are available.

Note: The emissivity affects the surface temperature only. Because of radiation, the temperatures at very small distances from the surface are again higher for a non coated face than for a coated one.

Usually, the energy content of the coating is small and will not affect the fire resistance properties of the composite panel. The following rules are valid for extended applications for EI classification:

- Variations in the coatings can be freely done if the PCS value is between 0 and 4 MJ/m<sup>2</sup>. The fire resistance test result and classification will be maintained as tested.
- If the PCS value is > 4 MJ/m<sup>2</sup> the fire resistance test result is valid for PCS values lower than 1,15\*PCS of the tested construction.
- If the PCS value is > 4 MJ/m<sup>2</sup> and > 1,15\*PCS of the tested construction the fire resistance test results can be reduced with the same % as the PCS value is over the tested one.
- If modifications in the coatings are made compared to the tested one the ignitability of the modified coating shall be > 250 °C.

For E-classifications where surface temperatures on the non-exposed side can be high the ignition temperature of the modified coating shall be higher than for the tested coating.

#### **K.5.2.2.2. Variations in face thickness**

##### **K.5.2.2.2.1 Metal sheet**

The metal sheet normally has a thickness between 0,3 and 1,5 mm. In composite panels with flat faces the metal sheets have no rigidity by themselves compared to the rigidity of the composite panel. The following rules are valid for extended applications:

- The thickness will have only a small effect on the I–insulation test result and the result is valid for thicknesses > 0,5\*thickness of sheets in the tested construction.
- For other thicknesses the effect on the I–insulation value shall be calculated with appropriate calculation methods (see K.5.4).
- The thickness will have a minor effect on the deflections of the composite panel in the early stage of a fire and can affect the E–integrity value in the test. The test result is valid for thicknesses +50 % of the thickness of sheets in the tested construction.

##### **K.5.2.2.2.2 Other materials**

Faces made out of other materials may have a wide variety of thicknesses. In composite panels with flat faces the faces have no or limited rigidity by themselves compared to the rigidity of the composite panel. The following rules are valid for extended applications:

- The thickness will have only a small effect on the I–insulation test result and the result is valid for thicknesses > 0,5\*thickness of sheets in the tested construction.
- For other thicknesses the effect on the I–insulation value shall be calculated with appropriate calculation methods (see K.5.4).
- The thickness will have a minor effect on the deflections of the composite panel in the early stage of a fire and can affect the E–integrity value in the test. The test result is valid for thicknesses > +50 % of the thickness of sheets in the tested construction.

#### **K.5.2.2.3. Variations in the face material**

The following rules are valid for extended applications:

- The test results are always valid for the same type of material than the tested one and which fulfils the requirements in the appropriate product test standard as the tested one.
- There are also panels with perforated metal sheets on one or both sides of the panels. For

these types a test result achieved with a perforated sheet is always valid for non-perforated sheets in the same position as in the tested product. Test results for a product tested with non-perforated sheets is valid only for a product with perforated sheets on the fire exposed side with a perforation area below 40 % and with a core material classified A2 or better. Other changes are not allowed.

#### **K.5.2.2.4. Variations in the sheet geometry**

There are two different types of sheet geometry, namely (i) flat sheets including also ribs and micro-profiled sheets (profiles up to 5 mm in depth) and (ii) corrugated sheets with profiles deeper than 5 mm. These types are acting in different ways in a fire and cannot be changed from the one type to the other. Minor changes within the type are allowed:

- (i) Test results are always valid for other flat or profiled sheets with profiles < 5 mm in depth.
- (ii) Ribs can be added or deleted according to (i) above but the dimensions in of the overall corrugation may not be changed.

#### **K.5.2.3. Variations in the adhesive**

This paragraph is valid only for panels with adhesively bonded cores. The following rules apply for an adhesive with no strength in high temperatures (> 500 °C) which means that the face on the exposed side will disconnect from the core in the very beginning of a fire and the construction will loose its composite strength capability. For this reason an organic adhesive can not be changed to a non-organic one or vice versa.

Usually the energy content of the adhesive is small and will not affect the fire resistance properties of the composite panel. The following rules are valid for extended applications:

- Variations in the adhesive can be freely done if the PCS value is between 0 and 4 MJ/m<sup>2</sup>. The fire resistance test result and classification will be maintained as tested.
- If the PCS value is > 4 MJ/m<sup>2</sup> the fire resistance test result is valid for PCS values lower than 1,15\*PCS of the tested construction.
- If the PCS value is > 4 MJ/m<sup>2</sup> and > 1,15\*PCS of the tested construction the fire resistance test results can be reduced with the same % as the PCS value is over the tested one.
- If modifications in the adhesive are made compared to the tested one the ignitability of the modified adhesive shall be > 250 °C.

If modifications in the adhesive are made compared to the tested one, the shear strength at 250 °C of the modified adhesive shall be greater than the tested one or > 500 kPa tested at 250 °C.

For E-classifications where surface temperatures on the non-exposed side can be high the ignition temperature of the modified adhesive shall be higher than for the tested one.

#### **K.5.2.4. Variations in the core material**

##### **K.5.2.4.1. General**

The following main core materials are used in composite panels: stone wool, glass wool, PIR, PUR, XPS, EPS, CG and modified PF. Their behaviour regarding fire is totally different and cannot be compared from one material to another.

Changes from one core material to another, are therefore never allowed in any extended application. Variations can be done only within the material group as following:

There are several factors in the different core materials affecting the fire properties of the core and of the composite panel. It is therefore not possible to extend the results from one core material supplier to be valid for apparently similar materials from another supplier.

##### **K.5.2.4.2. Stone wool**

Generally, the greater the density of the stone wool, the higher the flexural strength of the panel. Density will be dictated by room-temperature structural design. However, variation in density affects the I-insulation value. Reduction in density greater than 10 % of the nominal density of the as-fire-tested construction is not permissible unless there are small scale fire test data showing that the I-insulation value is not less than that in the as-fire-tested construction. Higher densities than that tested can be used in the density range 50 to 150 kg/m<sup>3</sup>.

Room temperature structural design will govern the orientation of fibres in lamellas or slabs used in the panels. Changes in orientation of fibres will have influence on fire resistance. This means that results from panels with lamellas cut in one direction are not valid for panels with lamellas cut in another direction.

Gaps between the lamellas or ends of lamella should be avoided. If this is true, then the amount of lamella joints could be increased with 50 % compared to the tested panel. A decrease in the amount of lamella joints is always allowed.

The mass of fibre-binder used per unit volume of stonewool will be governed by room-temperature structural design. Variation in binder content can affect the fire resistance properties and the following rules should be followed.

- Smaller amount of binder is always allowed compared to the tested one. Binder contents below 1,5 % can affect the strength properties in such a way that it must be validated with tests, if the binder content in the tested panels has been > 2 %.
- An increase in binder content with 2 %-units is allowed, if the total amount of binder is below 10 %. For example a result with 4 % binder is valid also for a core with 6 %.

The nature and proportions of materials used to manufacture the stonewool fibres shall not be varied from those used in the as-fire-tested construction. It shall not be assumed that materials from different suppliers within the same generic class have the same fire properties.

The chemistry of the binder shall not be varied from the as-fire-tested binder. The introduction of inorganic fillers or other materials may reduce the strength properties and alter the resistance to decomposition at elevated temperatures and is not permitted unless comparative small scale indicative fire resistance test results prove otherwise.

#### **K.5.2.4.3. Glass wool**

The low melting point of glass wool relative to stone wool limits the use of glass wool to panels of low fire resistance and the joint construction will be of even more importance than for stone wool. The above comments on stone wool apply equally to glass wool.

#### **K.5.2.4.4. PIR (polyisocyanurate)**

Some PIR-panels can have low fire resistance (EI) classifications. Even small changes in chemical composition can have a great influence on the test results and the results should be strictly used for the tested panels only. No extended application is allowed.

#### **K.5.2.4.5. PUR (polyurethane)**

Some PUR-panels can have low fire resistance (EI) classifications. Even small changes in chemical composition can have a great influence on the test results and the results should be strictly used for the tested panels only. No extended application is allowed.

#### **K.5.2.4.6. XPS (extruded polystyrene)**

Some XPS-panels can have low fire resistance (E) classifications. Even small changes in chemical composition can have a great influence on the test results and the results should be strictly used for the tested panels only. No extended application is allowed.

#### **K.5.2.4.7. EPS (expanded polystyrene)**

Some EPS-panels can have low fire resistance (E) classifications. Even small changes in chemical composition can have a great influence on the test results and the results should be strictly used for the tested panels only. No extended application is allowed.

#### **K.5.2.4.8. Modified PF (modified phenolic foam)**

Some modified PF-panels can have low fire resistance (E) classifications. Even small changes in chemical composition can have a great influence on the test results and the results should be strictly used for the tested panels only. No extended application is allowed.

### **K.5.3. Variations in the construction**

#### **K.5.3.1. Variations in span length**

The span length is the distance between the fixings of panels oriented either horizontally or vertically.

The span length has no influence on the I-classification and the span length can therefore be freely increased or decreased with remaining I-classification.

For E-classification a decrease in span length is always allowed. An increase is always allowed according to the direct application rules given in the appropriate test method standard. For bigger changes the following rules apply.

Two aspects of fire integrity are assessed:

- The ability of the whole panel assembly to resist collapse must be assessed when the adhesive bond fails and the panels lose their flexural strength. To resist collapse, the ends of the panel facings must be secured to the structure (the imaginary fire test wall frame in the extended application) using suspension details. The strength of the suspension details must be able to carry the dead loads at the temperatures they attain from an increased load of a longer span panel. This can be done by increasing the amount of fixings so that the load from the dead weight of the panel per fixing is lower than the tested one or by calculations with more accurate calculation methods.
- The ability of joints between adjoining composite panels to resist the passage of fire.

In horizontally oriented panels which span between columns or walls, both faces are subjected to in-plane shear stresses analogous to the pattern of stresses in the web of a steel I-beam. The stresses may be accompanied by out-of-plane deformations caused by gravity and the prevention of free thermal expansion at the ends of the faces when exposed to fire. Hence the stresses and deformations are complex in nature. Thin faces can suffer buckling and sagging, which means that openings may occur at horizontal panel joints, especially at mid-span, leading to unpredictable failure of integrity.

In vertically oriented panels it is assumed that after delamination, the faces hang like curtains from the top: the fastenings for the top of the fire-exposed face have to support the dead load of that face whereas the fastenings for the top of the unexposed face have to support the combined load of the face and the core for the entire fire resistance period. The rules for the fasteners are given above.

For both horizontally and vertically oriented panels the following rules apply:

- During the reference test, the deflection difference at midspan between the joint and the centres of the adjoining panels shall be measured throughout the test. The calculation method is given in chapter 6.
- During the reference test, the opening-up of the joint at the same places as above shall be measured during the test. The calculation method is given in chapter 6.
- If  $\Delta f < 0,01$  and  $\Delta c < 0,3$  the span can be increased up to 12 m with the same classification as the tested one.
- If  $\Delta f < 0,01$  and  $\Delta c < 0,5$  the span can be increased up to 6 m with the same classification as the tested one.
- If  $\Delta f > 0,01$  or  $\Delta c > 0,3$  the span can be increased up to 12 m with the same classification as the tested one if fixings are used at distances c/c 3000 or if core thickness is increased with 50 %, values between 4 and 12 m can be interpolated.
- If fixings are used the span can be increased up to 12 m with the same fixing type and c/c distances as in the tested assembly.
- Span lengths over 12 m are not allowed without more accurate test and/or calculation methods.

#### **K.5.3.2. Variations in the orientation of the panels**

It is not permissible to use a test result for a horizontally mounted panel assembly in an extended application for a vertically mounted panel system, or vice versa without test results to show that no differences in fire resistance appear between these two orientations. Test evidence for the thickest

panels will be valid also for other thicknesses. Other orientations could be interpolated between these two.

In most cases the fixing systems for vertically and horizontally mounted panels are not the same. This can restrict the use of extended applications for these types of changes.

#### **K.5.3.3. Variations in panel width**

Variations in the panel width can influence the integrity of the construction. The width can always be decreased without restrictions. Increase of panel width by +20 % can be made. If bigger changes are made tests for the smallest and biggest panels with thickest core shall be made. The worst value is valid for all other panel types.

#### **K.5.3.4. Variations in the panel thickness**

Variations in panel thicknesses are due to changes in thickness of the core material. An increase in thickness will lead to a better insulation value and a test result is therefore always valid for thicker panels. A decrease in thickness is not allowed.

If test results for three or more thicknesses are available results for other thicknesses can be inter- and extrapolated, if the failure mode (insulation or integrity) is the same for all results.

#### **K.5.3.5. Variations in the joint construction**

Even small changes in the joint construction can easily affect the integrity of the panel and are not allowed with the following exceptions:

- An increase in overlapping is always allowed if other dimensions remain unchanged.
- An increase in amount of fixings is always allowed.
- Tongue and groove joint in core material is allowed if tested as butted. Increase in overlapping is always allowed. Dimension changes in thicknesses in tongue and groove are allowed up to +50 %.
- Joints tested without sealants can always be sealed on the fire side. If sealed on the non exposed side the ignition temperature of the sealant material shall be > 250 °C for EI-classified structures. For E-classified structures, only non combustible sealants can be used on non exposed side, if tested without sealants.
- If a construction is tested with sealing materials in the joints test results are valid only for joints with the same type of sealing materials and are not valid for joints without sealants.

#### **K.5.3.6. Variations in the boundary conditions and fixing system**

Minor changes in the boundary conditions and fixing system are allowed provided that it can be shown that the bearing capacity is not reduced and the risk of collapse is not increased.

Some fixing systems can be protected. An increase in protection ability is always allowed. If protection ability is decreased and the non-influence is shown for one panel type the result is valid also for other panel types.

#### **K.5.3.7. Length and height of assembly**

For horizontal installation the height of the assembly can be freely increased as above and providing that each panel is fixed to the bearing structure in such a way that the load is not accumulated from above to the lower parts of the assembly. With vertical installation the length of the assembly can be freely increased providing that the boundary conditions for the reference test are as described in the test standard.

#### **K.5.3.8. Increasing the fire resistance by complementary materials**

A factory-applied fire protecting layer of material (e.g. board or intumescent coating) attached to the outside of a panel can be used to contribute to the required insulation and integrity performance if:

- a) the increased dead load can be carried by the panel-support fastenings and
- b) portions of the layer do not become detached from the panel

The insulation performance of fire protecting layers can be determined from small scale tests. Integrity performance must be proved in a full scale test to reproduce the different thermal movements of layer and panel (the thermal movements are complex functions of the different temperatures attained by layer and panel, the different coefficients of thermal expansion/contraction of layer and panel, and differences in internal stresses).

An intumescent coating is an acceptable layer, if it is compatible with the surface coating on the metal and if portions of the foam char layer do not become detached. Detachment can only be assessed in a full scale test. Detrimental effects such as the inappropriate use of cleaning agents, over-painting or the effects of UV degradation or high levels of moisture in the atmosphere may need to be considered. The behaviour of intumescent coatings in fire cannot be calculated with confidence.

#### K.5.4. Combined material variations

The situation with combined variations is always very complex and must be considered case by case. The following table can be used as guideline for the evaluation.

**Table K.3: Acceptability of parameter combinations for extended application**

	1. Change in face material	2. Change in adhesive	3. Change in core material	4. Change in span length	5. Change in orientation	6. Change in panel width	7. Change in thickness	8. Change in joint construction	9. Change in fixing system	10. Change in length	11. Change in height
1. Change in face material	-	Yes	Yes	No*	Yes	Yes	Yes	Yes	No*	Yes	Yes
2. Change in adhesive	Yes	-	Yes	Yes	Yes	Yes	Yes	Yes	Yes	Yes	Yes
3. Change in core material	Yes	Yes	-	No*	No	Yes	Yes	Yes	No*	Yes	Yes
4. Change in span length	No*	Yes	No*	-	No	No*	No*	Yes	No	Yes	Yes
5. Change in orientation	Yes	Yes	No	No	-	Yes	Yes	Yes	No	Yes	Yes
6. Change in panel width	Yes	Yes	Yes	No*	Yes	-	Yes	Yes	No*	Yes	Yes
7. Change in thickness	Yes	Yes	Yes	No*	Yes	Yes	-	Yes	No*	Yes	Yes
8. Change in joint construction	Yes	Yes	Yes	Yes	Yes	Yes	Yes	-	Yes	Yes	Yes
9. Change in fixing system	No*	Yes	No*	No	No	No*	No*	Yes	-	Yes	Yes
10. Change in length	Yes	Yes	Yes	Yes	Yes	Yes	Yes	Yes	Yes	-	No
11. Change in height	Yes	Yes	Yes	Yes	Yes	Yes	Yes	Yes	Yes	No	-

\* In such changes where load is increased the bearing capacity of the fixings must be checked and amount increased. Other change combinations are allowed.

#### K.5.5. Supporting construction

The panel assembly is a non-loadbearing wall and is always fixed to a supporting construction. The supporting construction is not normally included in the fire test, but is essential to the functioning of the panels. In a fire test, the supporting construction is the test frame into which the assembly is mounted. The material of the frame can vary from one laboratory to another, but it can be assumed that the frame is rigid without any big deflections. In practice, the panel assembly can be fixed to different types of supporting constructions. The test results are valid if the following requirements on the supporting construction are fulfilled.

- The supporting construction has at least the same fire resistance classification for loadbearing capacity as the panel assembly has for insulation and/or integrity.
- The thermal movements of the supporting construction will not impose any loads on the panel assembly that can affect the integrity properties of the tested assembly.

- The fixing system has the same loadbearing capacity in the supporting construction as in the frame used in the test.

### **K.5.6. Heating conditions**

This standard deals with extended application of constructions tested according to the standard EN 1364-1. If the test is conducted according to the standard heating curve given in EN 1363-1, the test results are valid also for the external fire exposure curve given in EN 1363-2.

## **K.6. Small scale tests and calculation methods**

### **K.6.1. Small scale tests**

There are a lot of small scale test methods available for measuring fire resistance and strength properties for materials and products. Whenever it is possible EN-standards shall be used. These test methods have not been described in this annex.

For determining and comparing temperatures and insulation values for different constructions it is cheaper and more convenient to use small scale test furnaces. When this has been suggested as a possibility in the rules in chapter 5 a furnace with minimum opening dimensions of 1 by 1 m shall be used, together with the appropriate time-temperature curve used in the reference test. One test for each parameter change shall be used and the results shall always be compared to the reference construction tested in the same furnace.

### **K.6.2. Calculation methods**

#### **K.6.2.1. General**

Calculation methods shall be confined to calculations of insulation and integrity (including capacity of panel suspension fastenings to carry the weight of the panel). Methods may be empirical, theoretical or a combination of both. Wherever possible temperature data shall be derived from fire tests, but results of computer models shall be acceptable where they have been adequately validated (thermally and mechanically) for the fire test conditions.

#### **K.6.2.2. Interpolation and extrapolation**

Interpolation of temperature data is acceptable as a simple calculation method. It can be used to derive core thicknesses, when the core is not subject to charring and/or melting or other phenomena which affect the thermal insulation. If a linear equation ( $y = a + b \cdot x$ ) can be assumed to apply, the thickness of the necessary core can be calculated in a simple manner.

Note: Example: if the thickness of insulation is 25 mm at 30 minutes in one test and 100 mm at 120 minutes in another test, the thickness needed for an I-Insulation of 60 minutes is:  $25 + 30 \cdot (100 - 25) / (120 - 30) = 50$  mm

As a general rule, however, there should be three data points available to allow for non-linear effects when interpolating. Interpolation is achieved by plotting the data points on a graph and drawing a best-fit curve. Extrapolation is not allowed.

#### **K.6.2.3. Calculation of strength properties**

An easy way to validate the loadbearing capacity of fasteners and fixing system is to calculate the imposed load per fastener in the reference test and fix the amount of fasteners so that the load per fastener imposed by the changes made is less than in the reference test. More accurate calculation methods can also be used.

Calculations of panel-fastening suspension capacity should be made:

- a) for the exposed face after it has delaminated from the core, and
- b) for the unexposed face assuming it carries the whole weight of the core material.

Temperature data is needed at the panel head detail and this data should be obtained from several thermocouples mounted on the test specimen specifically for this purpose. Strength loss of the

faces and other assembly details, which transmit the load at the panel head, should be calculated and fastening pull-out data used to check that the dead loads can be carried throughout the test period.

Several changes will have an impact on the load carried by the adhesive layer. To assess an extended application the strength of the adhesive bond between the core and face material in 250 °C must be known. The best way of doing this is to do a tensile test at this temperature according to the test method given in the product standard.

#### K.6.2.4. Calculation of insulation properties

Generally, the integrity behaviour of panel joints cannot be calculated. However, panel joints which work on an overlapping interlocking sliding joint principle will, with sufficient expansion allowance, better resist integrity failure caused by expansion/distortions of the face.

The temperatures and insulation properties of a construction can be calculated and different changes to the construction thus validated by computer programmes. When using these types of programmes at least the following must be taken into account:

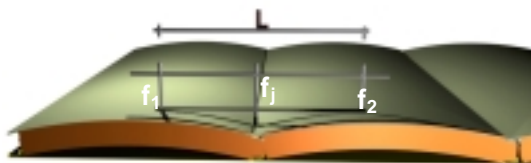
- In all calculations the same time-temperature curve shall be used as in the reference test.
- The construction tested in the reference test shall always be calculated and the calculation results shall be within  $\pm 10\%$  compared to the test results. If not, the input values must be changed.
- The thermal resistance values of most materials are strongly temperature dependent. These values for different temperatures between 20 and 1100 °C for the core material must be known.
- The fire exposed face will normally detach from the core at an early stage of a fire. The thermal properties of the face can therefore not be taken into account.
- The emissivity of the non exposed face is of great importance for the temperatures and must therefore be known and taken into account in the calculation program.

#### K.6.3. Additional measurements to be done in the reference test

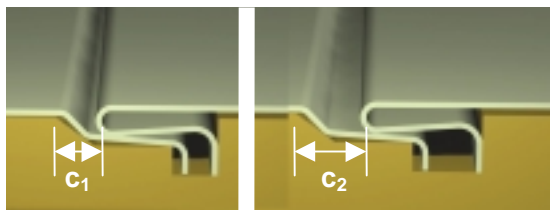
Some extended applications need additional measurements from the reference test. If these are necessary, the ETA-applicant must ask for them when ordering the reference test.

The following data could be used and measured:

- Heat flow through the panel during the test.
- Additional temperature measuring points on the fastenings and fixings
- Additional temperature measuring points below any kind of protections and additional materials
- The deflections of the panel assembly in both directions
- Measurements on joint behaviour according to the pictures below.



$$\Delta f = (f_j - 0.5 \cdot (f_1 + f_2)) / L$$
 Figure 1 - Measuring of  $\Delta f$



$$\Delta c = (c_2 - c_1) / L$$
 Figure 2 - Measuring of  $\Delta c$



## **ANNEX L**

### **EXAMPLE OF A EUROPEAN TECHNICAL APPROVAL (ETA)**

To improve equivalency between ETAs being produced by the EOTA Member Bodies, on the basis of ETA-Guideline CSR, this Annex provides an example of an ETA.

Approval Bodies are requested to use the terminology as specified in Annexes A and B of the ETA-Guideline to improve common understanding and simplify translation.

All the information included in this Example ETA is fictional. Any similarity between the ETA-Holder, the products or its components and any real companies or products is purely accidental  
The Example ETA contains guidance from the ETA-Format (in italics) and text that is intended to be replaced (in italics and between [...]).

Authorised and notified according to Article 10 of the Council Directive of 21 December 1988 on the approximation of laws, regulations and administrative provisions of Member States relating to construction products (89/106/EEC).

Name and address of approval body issuing the ETA

Logo of approval body issuing the ETA

**European Technical Approval**      **ETA-...** (number under EOTA numbering system)

<b>Trade name:</b>	Coldy 1 and 2	<i>Give trade name(s), if any, or other reference of product(s) as used in the Community (and other EEA countries) for marketing the product(s). The trade name(s) or other reference of product(s) should not lead to misunderstanding concerning the performance or intended use of the product(s).</i>
<b>Holder of the approval:</b>	Cold Company Temperature Lane 273 9999 County Country	<i>Give name and address of the manufacturer or his nominated agent established in the Community to whom the ETA was issued (Article 9(3) of Council Directive 89/106/EEC, hereinafter referred to as the 'CPD'; point 2.1 of the Common Procedural Rules, hereinafter referred to as the 'CPD', in the Annex to Commission Decision 94/23/EC).</i>
<b>Generic type and use of construction product(s):</b>	Cold storage room kit for inside works	<i>Indicate generic type and intended use of product(s) covered by the ETA as well as main performance levels/classes, if relevant (according to Article 3(2) and Article 6(3) of the CPD), first in the official language(s) of the issuing EOTA body and then in English translation. (Article 8(4) of the CPD)</i>
<b>Validity from:</b>	2004-02-30	
<b>to:</b>	2009-02-30	
<b>Manufacturing plant(s):*</b>	Cold Company Temperature Lane 273 9999 County Country	<i>Indicate manufacturing plant(s). If there are a large number of plants/places of manufacture, they should be indicated in an Annex to which reference should be made here.</i>
<b>This European Technical Approval contains:</b>	27 pages including 1 Annex which forms an integral part of the document.	<i>Indicate total number of pages (text and drawings, if any, in main part and annexes) and number of annexes.</i>



European Organisation for Technical Approvals  
Organisation Européenne pour l'Agrément Technique  
Europäische Organisation für Technische Zulassungen

\* Indication of manufacturing plant(s) only if necessary for technical reasons, e.g. because of assumptions made under II.4.1 Manufacturing. When appropriate for practical reasons or if the ETA holder wishes, the manufacturing plant(s) may also be laid down in a non-published supplement to the ETA kept by the issuing body and is to be communicated only to the approved bodies involved in the conformity attestation procedure.

## I LEGAL BASES AND GENERAL CONDITIONS

1 This European Technical Approval is issued by [name of approval body] in accordance with the

- Council Directive (89/106/EEC)<sup>2</sup> of 21 December 1988 on the approximation of laws, regulations and administrative provisions of Member States relating to construction products
- [Indicate respective national law transposing the CPD; only if the national law of Member State of issuing approval body so requires]
- Common Procedural Rules for Requesting, Preparing and Granting of European Technical Approvals set out in the Annex to Commission Decision 94/23/EC<sup>3</sup>
- Guideline [number and title] (indicate title and number of ETA Guideline on the basis of which the ETA is issued).

2 The [name of issuing approval body] is authorised to check whether the provisions of this European Technical Approval are met. Checking may take place in the manufacturing plant(s) (for example concerning the fulfilment of assumptions made in this European technical approval with regard to manufacturing). Nevertheless, the responsibility for the conformity of the products with the European Technical Approval and for their fitness for their intended use remains with the holder of the European Technical Approval.

3 This European technical approval is not to be transferred to manufacturers or agents of manufacturers. (Possibly, the following may be added: "other than those indicated on page 1, or manufacturing plants other than those / indicated on page 1 / laid down in the context of this European technical approval" (delete as appropriate)).

4 This European Technical Approval may be withdrawn by [name of issuing approval body] pursuant to Article 5.1 of the Council Directive 89/106/EEC.

5 Reproduction of this European technical approval including transmission by electronic means shall be in full. However, partial reproduction can be made with the written consent of [name of issuing approval body]. In this case partial reproduction has to be designated as such. Texts and drawings of advertising brochures shall not contradict or misuse the European technical approval.

6 The European technical approval is issued by the approval body in its official language(s).

7 These versions should correspond fully to the version used by EOTA for circulation. Translations in other languages have to be designated as such.

<sup>2</sup> Official Journal of the European Communities N° L40, 11 Feb 1989, p 12

<sup>3</sup> Official Journal of the European Communities N° L17, 20 Jan 1994, p 34

## II SPECIFIC CONDITIONS OF THE EUROPEAN TECHNICAL APPROVAL

### 1. Definition of product(s) and intended use

#### 1.1. Scope

##### 1.1.1. General

This ETA covers prefabricated cold storage room kits for installation inside an existing building. The room is made out of sandwich panels with external and internal faces made of steel or stainless steel sheet and a homogeneous thermally insulating core, which consists of polyurethane.

The cold storage rooms are designed for uses between +15°C and -25°C.

The assumed intended working life of the cold storage room kit for the intended use is 10 years<sup>4</sup>, provided that the assembled cold storage room is subject to appropriate use and maintenance.

Notes:

- Technical equipment is not covered by this ETA, but the ETA-Holder does also supply refrigeration systems, condensing units and evaporator coils.
- When a waterproof membrane is added, these cold storage room kits may also be used externally, but this intended use is not covered by this ETA.
- These kits may also be made available as a volumetric cold storage room unit, but this intended use is not covered by this ETA.
- These cold storage room kits can also be made available with sandwich panels based on mineral wool insulation, but these uses are covered by another ETA.

##### 1.1.2. Overview of characteristics covered in this ETA

The table below indicates which performance characteristics have been declared in this ETA and the corresponding ETA paragraphs<sup>5</sup>.

---

<sup>4</sup> The indications given as to the working life of the cold storage room kit cannot be interpreted as a guarantee given by the ETA-holder or the approval body. It should only be regarded as a means for the specifiers to choose the appropriate criteria for cold storage room kits in relation to the expected, economically reasonable working life of the works.

<sup>5</sup> Shaded areas are not relevant. Where no paragraph has been indicated, either the characteristic is not relevant for the kits covered by this ETA, or the ETA-holder has opted to use the "No Performance Declared" option.

Performance characteristics	For the kit as a whole	For the following kit components						
		Composite panels	Doors	windows	Fixing systems	Sealants	Gaskets	Building hardware
Reaction to fire		2.2.1	2.3.1.1		2.4.1	2.4.1	2.4.1	2.4.1
Fire resistance	2.1.1		2.3.1.2					
Dangerous substances	2.1.2.1	2.2.2.1	2.3.2.1		2.4.2.1	2.4.2.1	2.4.2.1	2.4.2.1
Water vapour permeability	2.1.2.2	2.2.2.2	2.3.2.2		2.4.2.2	2.4.2.2	2.4.2.2	2.4.2.2
Moisture resistance	2.1.2.3							
Fitness for contact with food and feedstuffs	2.1.2.4 2.1.2.5	2.2.2.3	2.3.2.3		2.4.2.3	2.4.2.3	2.4.2.3	2.4.2.3
Impact resistance	2.1.3.1		2.3.3.1					
Fixing resistance		2.2.3.1			2.4.3			
Mechanical resistance of wall, ceiling and floor panels		2.2.3.2						
Mechanical resistance of cold storage rooms	2.1.3.2							
Resistance to eccentric loads		2.2.3.3						
Slipperiness of floor surfaces	2.1.3.3							
Safety against personal injuries by contact	2.1.3.4							
Safety against entrapment			2.3.3.2					
Safety against collapse	2.1.3.5							
Thermal performance		2.2.4	2.3.4		2.4.4	2.4.4	2.4.4	2.4.4
Air permeability	2.1.4							
Compatibility of components used	2.1.5.1.1							
Influences from stored products	2.1.5.1.2							
General durability of components		2.2.5.1	2.3.5.1		2.4.5.1	2.4.5.1	2.4.5.1	2.4.5.1
Rigidity and robustness	2.1.5.2							
General serviceability aspects of composite panel finishes		2.2.5.2						
Performance characteristics of finishes		2.2.5.2						
Floor finishes		2.2.5.2						
Behaviour of doors and windows between two different environments			2.3.5.2					
Behaviour of doors under repeated opening and closing			2.3.5.2					
Doors and windows under operating forces			2.3.5.2					
Behaviour of doors under loads			2.3.5.2					
Presence of defrost provisions for doors			2.3.5.2					
Declaration of the light transmittance			2.3.5.2					
General serviceability of fixing systems, sealants, gaskets and building hardware							2.4.5.2	
General serviceability of ancillary components								
Identification – Overview of identification properties	1	1.3.1 1.3.2	1.3.3		1.4	1.4	1.4	1.4

Example ETM

## 1.2. Definition of the kit

### 1.2.1. General

The cold storage room kit is being made available in the following types:

#### Coldy 1:

Free-standing cold storage room kit, with polyurethane insulated sandwich panels, which can be made available with and without floor panels. If the floor panels are not part of the kit, the floor finishing is not covered by this ETA.

#### Coldy 2:

This kit is supported by an internal metal framework, with polyurethane insulated sandwich panels, always without floor panels. An intermediate ceiling support, fastened to the structure of the building can be supplied. The floor finishing is not covered by this ETA.

The assembled kits can have the following dimensions:

- Maximum length: 15 m
- Maximum width: 6 m (Coldy 1) or 12 m (Coldy 2)
- Height: 2,60 m

These types are being put onto the market with the following components:

**Table 1.1: Cold storage room kit types covered by this ETA-Guideline**

	Cold storage room kit types	
	Coldy 1	Coldy 2
Wall panels	X	X
Ceiling panels	X	X
Floor panels	X	-
Doors:		
- Colddoor CD01	X	X
- Colddoor CD02	X	X
- Colddoor CD03	X	X
- Colddoor CD04	X	X
- Colddoor CD05	-	X
Galvanised steel sheet faces:		
- Basic protection		G1
- Polyester coated ( $\geq 20 \mu\text{m}$ )		G2
- Polyester coated ( $\geq 30 \mu\text{m}$ )		G3
- Plastisol coated ( $\geq 150 \mu\text{m}$ )		G4
Stainless steel faces:		
- Basic protection		S1
- Polyester coated ( $\geq 20 \mu\text{m}$ )		S2
Particularities of the design system: The design system allows assembled cold storage rooms to be relocated. On site cutting is not allowed.		

### 1.2.2. Designation:

The Cold storage room kits are designated as follows:

- Type of kit (Coldy 1 or 2), by C1/2
- Type of faces used, by G1/2/3/4 or S1/2
- Panel thickness: 60/80/100/120/150
- The type of door or doors: CD01/02/03/04/05
- Other components and/or ancillary components

Example: C2-G2-100-CD02  
PRV-001

## 1.3. Components

### 1.3.1. Wall, ceiling and floor panels

#### 1.3.1.1. Wall and ceiling panels

Composite panels with external and internal faces made of steel or stainless steel sheet and a homogeneous thermally insulating core, which consists of polyurethane. A number of finishings are possible (see §1.3.1.3.3).

The thickness of the insulation core is respectively (60 ± 1) mm, (80 ± 1) mm, (100 ± 1) mm, (120 ± 1) mm or (150 ± 1) mm.

The wall and ceiling panels are supplied with tongue and groove connection. Each panel also has respectively 3 and 5 interlocks in the transversal and longitudinal direction.

Dimensions:

- thickness: See above
- length/height: (2,60 ± 0,05) m
- width: (0,60 ± 0,05) m

#### 1.3.1.2. Floor panels

Composite panels with external faces made of steel or stainless steel sheet, the internal faces made out of wood-based boards, with a resilient floor covering, and a homogeneous thermally insulating core, which consists of polyurethane. A number of finishings of the metal sheets are possible (see §1.3.1.3.3).

The thickness of the insulation core is respectively (60 ± 1) mm, (80 ± 1) mm, (100 ± 1) mm, (120 ± 1) mm or (150 ± 1) mm.

The floor panels are supplied with tongue and groove connection. Each panel also has respectively 3 and 5 interlocks in the transversal and longitudinal direction.

#### 1.3.1.3. Materials

##### 1.3.1.3.1. Insulation - Polyurethane foam:

Polyurethane foam produced in accordance with EN 13165. Designation code: PUR - EN 13165 – T2 - DS(TH)9 – DLT(2)5 – CS(10)100 – CC(3/2/25)40 – TR1 – FW1 – WL(T)2 – MU60

### 1.3.1.3.2. Face materials

#### 1.3.1.3.2.1. Steel sheet:

Galvanised steel sheet, class 1, produced in accordance with EN 508-1, with a thickness of  $(0,700 \pm 0,005)$  mm. Designation: S350GD+ZA 255. A number of finishes are possible (see table 1.2).

#### 1.3.1.3.2.2. Stainless steel sheet:

Stainless steel sheet, class 1, produced in accordance with EN 508-3, with a thickness of  $(0,600 \pm 0,005)$  mm. Designation: X5CrNi18-10. For very aggressive environments, the stainless steel sheet can be finished with a PVDF coating ( $\geq 40\mu\text{m}$ ).

#### 1.3.1.3.2.3. Wood-based board

Multi layer solid wood panel, thickness  $(20 \pm 1)$  mm, in accordance with EN 13353

#### 1.3.1.3.3. Coatings and paints

Depending on the intended use, the manufacturer supplies the following coatings on the galvanised steel sheet:

**Table 1.2: Finishings for galvanised steel sheet**

Type of finishing	Thickness	Intended use
Basic protection	$\geq 10 \mu\text{m}$	I
Polyester	$\geq 20 \mu\text{m}$	II
	$\geq 30 \mu\text{m}$	III and IIIa
Plastisol	$\geq 150 \mu\text{m}$	IV and IIIa

Depending on the intended use, the manufacturer supplies the following coating on the stainless steel sheet:

**Table 1.3: Finishings for stainless steel sheet**

Type of finishing	Thickness	Intended use
Basic protection		IIIa
PVDF	$\geq 40 \mu\text{m}$	IV and IVb

#### 1.3.1.3.4. Floor coverings

Floor covering material: Linoleum floor covering in accordance with EN 548 and prEN 14085. The floor covering is  $(0,50 \pm 0,05)$  mm thick, the maximum width is  $(3,00 \pm 0,02)$  m. It is available in blue, white and grey colour.

#### 1.3.1.4. Interlock system “Camy”

Two part interlock with polystyrene case and glass reinforced nylon hook and galvanised steel axle. The Camy interlock panel system is available in sizes that correspond with the panel thickness. The

Camy interlock mechanism provides a fastening system which pulls the panels tightly together in order to achieve an air and water vapour barrier.

### 1.3.2. Supporting Framework and profiles

#### 1.3.2.1 Corner profiles (CP)

The ETA-holder supplies rounded corner profiles (see figure ...) made out of aluminium sheet. The profiles are  $(100 \pm 5)$  mm high and  $(4,00 \pm 0,05)$  m long. The corner profiles have a min. radius of 5mm.

At internal and external corners, connecting corner pieces should be used.

#### 1.3.2.2. Assembly profiles (AP)

For Coldy 1 type cold storage room kits, PVC assembly profiles, with square section, shall be used at intersections between wall/ceiling, wall/wall and wall/floor panels. These assembly profiles can be connected to the wall, ceiling and floor panels, using interlocks.

The profiles have respectively the same dimensions and length as the thickness of the panels and the length of the panels.

#### 1.3.2.3. Separating profiles (SeP)

For Coldy 1 type cold storage room kits, separating profiles should be used, to improve ventilation beneath the floor panels. These square PVC assembly profiles measure  $(50 \pm 1)$  mm and are  $(3,00 \pm 0,05)$  m long. They should be used at 400 mm (or smaller) distances.

#### 1.3.2.4. Supporting profiles (SuP)

##### 1.3.2.4.1. Metal framework

For Coldy 2 type cold storage room kits, steel profiles are being used to support the cold storage room enclosure. These profiles are in conformity with EN 10327.

##### 1.3.2.4.2. Ceiling support system

For Coldy 2 type cold storage room kits, the following ceiling support system may be part of the kit: metal suspension components in accordance with prEN 13964.

### 1.3.3. Doors

#### 1.3.3.1. General

Composite panels with external and internal faces made of steel or stainless steel sheet and a homogeneous thermally insulating core, which consists of polyurethane. A number of finishings of

the metal sheets are possible (see §1.3.1.3.3).

All doors are available with (60 ± 0,05) mm, (80 ± 0,05) mm, (100 ± 0,05) mm, (120 ± 0,05) mm or (150 ± 0,05) mm insulation thickness.

All doors are available with the following accessories:

- Crash barriers either on one side or both sides
- Kickplate, stainless steel or ribbed rubber mat
- Sunk threshold heating unit, aluminium section

Accessories for power operated doors:

- Foot traffic switches, which open the door partially and close it immediately after entering
- Photocell for automatic closing
- Pushbutton or infrared control, instead of pull switch

These accessories (see §1.3.5) have not been assessed.

### 1.3.3.2. Door types

#### 1.3.3.2.1. Colddoor CD01

Single hinged door. Composite panels with external and internal faces made of steel or stainless steel sheet and a homogeneous thermally insulating core, which consists of polyurethane. A number of finishings are possible (see §1.3.1.3.3).

All doors are available with (60 ± 0,05) mm, (80 ± 0,05) mm, (100 ± 0,05) mm, (120 ± 0,05) mm or (150 ± 0,05) mm insulation thickness.

Features:

- hinges are equipped with bearings
- handles on both sides
- EPDM rubber gasket
- adjustable double rubber sweeper gasket at the bottom of doors

Dimensions (see figure ...):

- height (h): (2,20 ± 0,05) m
- width (w): (1,10 ± 0,05) m
- door opening (width): (1,00 ± 0,05) m
- door opening (height) or (2,00 ± 0,05) m or (2,10 ± 0,05) m

#### 1.3.3.2.2. Colddoor CD02

Double hinged door. Composite panels with external and internal faces made of steel or stainless steel sheet and a homogeneous thermally insulating core, which consists of polyurethane. A number of finishings are possible (see §1.3.1.3.3).

All doors are available with (60 ± 0,05) mm, (80 ± 0,05) mm, (100 ± 0,05) mm, (120 ± 0,05) mm or (150 ± 0,05) mm insulation thickness.

Features:

- surface 1,25 mm stainless or galvanised steel sheet
- combined handle and latching device, handle also on the inside
- other door leaf with quick release bolt on the inside
- EPDM rubber gasket.
- adjustable double rubber sweeper gasket at the bottom of doors

Dimensions (see figure ...):

- height (h): (2,20 ± 0,05) m
- width (w): (2,20 ± 0,05) m
- door opening (width): (2,00 ± 0,05) m
- door opening (height) or (2,00 ± 0,05) m or (2,10 ± 0,05) m

#### 1.3.3.2.3. Colddoor CD03

Single sliding door. Composite panels with external and internal faces made of steel or stainless steel sheet and a homogeneous thermally insulating core, which consists of polyurethane. A number of finishings are possible (see §1.3.1.3.3).

All doors are available with (60 ± 0,05) mm, (80 ± 0,05) mm, (100 ± 0,05) mm, (120 ± 0,05) mm or (150 ± 0,05) mm insulation thickness.

Features:

- guide rail at lower edge
- anodised aluminium slide rail
- door moves along the rail with wheels fitted with ball bearings
- floor mounted guide rail
- anodised aluminium handle on the outside; sunk plastic cup handle on the inside
- sealing strip and sweeper gasket, EPDM rubber

Dimensions (see figure ...):

- height (h): (2,20 ± 0,05) m
- width (w): (1,10 ± 0,05) m
- door opening (width): (1,00 ± 0,05) m
- door opening (height) or (2,00 ± 0,05) m or (2,10 ± 0,05) m

#### 1.3.3.2.4. Colddoor CD04

Single sliding heavy duty door. Composite panels with external and internal faces made of steel or stainless steel sheet and a homogeneous thermally insulating core, which consists of polyurethane. A number of finishings are possible (see §1.3.1.3.3).

All doors are available with (60 ± 0,05) mm, (80 ± 0,05) mm, (100 ± 0,05) mm, (120 ± 0,05) mm or (150 ± 0,05) mm insulation thickness.

Features:

- surface 1,25 mm stainless or steel sheet
- slide rail anodised aluminium section



- door moves along the rail with wheels fitted with ball bearings; lower guide rails fitted to the floor. stainless steel handles on both sides
- sealing strip and sweeper gasket, EPDM rubber

Dimensions (see figure ...):

- height (h):  $(2,20 \pm 0,05)$  m
- width (w):  $(1,10 \pm 0,05)$  m
- door opening (width):  $(1,00 \pm 0,05)$  m
- door opening (height) or  $(2,00 \pm 0,05)$  m or  $(2,10 \pm 0,05)$  m

### 1.3.3.2.5. Colddoor CD05

Double swing, power operated door for vehicle traffic. Composite panels with external and internal faces made of steel or stainless steel sheet and a homogeneous thermally insulating core, which consists of polyurethane. A number of finishings are possible (see §1.3.1.3.3).

All doors are available with  $(60 \pm 0,05)$  mm,  $(80 \pm 0,05)$  mm,  $(100 \pm 0,05)$  mm,  $(120 \pm 0,05)$  mm or  $(150 \pm 0,05)$  mm insulation thickness.

Features:

- guide rail at lower edge
- slide rail, anodised aluminium section
- door moves along the rail with wheels fitted with ball bearings
- floor mounted lower guide rails
- stainless steel handles on both sides
- sealing strip and sweeper gasket, EPDM rubber machinery: Driving gear consists of a worm gear and a standard squirrel-cage motor, output 0,37 kW; door movement with chain gear
- standard control: Control unit is installed next to the door machinery in front of the slide rail; the unit contains the electronics for closing and opening the door and a connection from the safety feature; safety feature is based on an electric bellows located at the outer edge of the door leaf; connection voltage, 3~400 V 50 Hz
- optional control system: Control unit is wall mounted at working height on the side of the wall where the door opens; the unit is fully electronic and contains the automatics for smooth opening and closing of the door; safety feature is based on a pneumatic bellows located at the outer edge of the door leaf
- connection voltage, 3~400 V 50 Hz

Dimensions (see figure ...):

- height (h):  $(2,20 \pm 0,05)$  m
- width (w):  $(2,20 \pm 0,05)$  m
- door opening (width):  $(2,00 \pm 0,05)$  m
- door opening (height) or  $(2,00 \pm 0,05)$  m or  $(2,10 \pm 0,05)$  m

## 1.3.4. Fixing systems, sealants, gaskets and building hardware

### 1.3.4.1. Building hardware

#### 1.3.4.1.1. Hinges with bearings

Specification

#### 1.3.4.1.2. Handles

Specification

#### 1.3.4.1.3. Combined handle and latching device

Specification

#### 1.3.4.1.4. Quick release bolt

Specification

### 1.3.4.2. Gaskets - EPDM Rubber gaskets, sealing strips and rubber sweepers

These have the following physical characteristics:

Table 1.4: Characteristics of gaskets

Characteristic	Verification method	Value
Density	EN ISO 845	$(25 \pm 1)$ kg/m
Dimensions	-	...
Colour	-	Grey
Close Force	prEN 12365-1	$\leq 30$ N
Deflection Recovery	prEN 12365-1	$\geq 70$ %
Tensile strength	EN ISO 527-1	$\geq 5$ Mpa
Elongation at break	EN ISO 527-1	$\geq 25$ %
Long Term Recovery	prEN 12365-1	$\geq 60$ %
Long term working range 5 mm x 7 mm	prEN 12365-1	$\geq 3,5$ mm

### 1.3.4.3. Fixing systems

#### 1.3.4.3.1. Panel interlock system

See §1.3.1.4

#### 1.3.4.3.2. Fixing system for Coldy 2 kit type

Stainless steel self tapping screws, with the following specifications (EN ISO 3506-1):

Table 1.5: Stainless steel self tapping screw performances

Length:	100mm, 120mm, 140mm, 160mm or 200mm
Diameter:	5mm, 6mm, 7mm, 8mm or 10mm
Tensile strength of the raw material	
Elastic limit	
Elongation at rupture	
Hardness	

### 1.3.4.4 Sealant – “Seal perfect”

Silicone sealant, curing with atmospheric moisture in accordance with ISO 11600, type F-25LM. These should not be applied to surfaces in direct contact with food, nor for submerged joints. The silicone sealant is only intended for reparations.

**Table 1.6: Silicone sealant performances**

Curing System	Oxime
Standard Colours	Brilliant White, Translucent
Packaging	25 x 310 ml Cartridges (both colours)
Hardness	Shore A 17
Movement accommodation	≥ 25 %
Application Temperature Range	+ 5 °C to + 40 °C
Service temperature range	-50 °C to + 150 °C
Tooling time (approx.)	10 minutes
Tack free time (approx.)	30 minutes
Full cure	1 - 5 days

### 1.3.5. Ancillary components

The following ancillary components may be part of cold storage room kits supplied by the ETA-holder, but these have not been assessed and are not covered by this ETA, but the incorporation of the ancillary components, in accordance with the ETA-holder's specifications, does not reduce the cold storage room kits' capacity to comply with the essential requirements.

#### 1.3.5.1. Pressure relief provision (PRV-001)

The PRV-001 pressure relief valve incorporates two semi-circular hinged flaps designed to open at small pressure differentials and allow rapid air movement. A heater plate connected to the hinge pin ensures free movement of the flaps at all times. The valve is supplied with powder coated white enamelled steel cover plates, for fitment inside and outside the cold storage room (see figure ...).

#### 1.3.5.2. Strip curtains “Strippy”

Plastic vinyl strip curtains are used in deep-freeze stores in addition to normal hinged or sliding doors. They can be ordered in “Standard”, “Embossed”, “Low Temper” or “DayLight” for different applications.

The vinyl strips are extruded with designed curve so that alternate strips fit together to form a superior seal against the elements, while still spreading apart easily to allow traffic through. The edges are round and smooth to prevent accidental cutting, scratching or snagging. The material is flame retardant and resists most inorganic acids. The square mounting hardware eliminates stress on the strips which increases life expectancy. Support

tubes and swivel brackets are made from galvanized and zinc plated steel for strength and durability. Individual strip replacement (when needed) is possible.

#### 1.3.5.3. Crash barriers

Specification

#### 1.3.5.4. Kickplate

Stainless steel or ribbed rubber mat on all types of doors

#### 1.3.5.5. Sunk threshold heating unit, aluminium section for all types of doors

Specification

#### 1.3.5.6. Accessories for power operated doors:

##### 1.3.5.6.1. Foot traffic switches, which open the door partially and close it immediately after entering

Specification

##### 1.3.5.6.2. Photocell for automatic closing

Specification

##### 1.3.5.6.3. Pushbutton or infrared control, instead of pull switch

Specification

## 2. Characteristics of product(s) and methods of verification

*Indicate precise and measurable characteristics and parameters of the product(s) and its (their) constituents and components, where appropriate, with due consideration of the ETA Guideline mandate for the relevant product family, prepared by the Commission, or, when dealing with product(s) based on the procedure under Article 9 (2) of the CPD, directly with the relevant essential requirements (Annex I to the CPD) and interpretative documents (IDs) and levels or classes of performance according to clause 1.2 of IDs, in so far as relevant. Also take account of further requirements, if any (e.g. resulting from other Commission Directives).*

*Indicate other aspects of serviceability including specified characteristics for identification of product(s), in so far as necessary.*

*Where product characteristics or parameters require confidentiality (e.g. chemical composition of certain materials), these are not to be indicated in the ETA itself, but kept by the issuing approval body in the technical documentation of the ETA and handed over only to the approved bodies involved in the conformity attestation procedure in so far as is necessary for their testing, inspection and certification tasks.*

*Summarize procedures by which judgements on durability, product characteristics and performance have been made. Refer to ETA Guidelines and/or harmonized, recognised national or other standards (test methods, methods of calculation, etc.) and indicate relevant values and parameters obtained from results as appropriate and necessary for the use of the product and the design of the works or part of works in which the product is used.*

*Summarise any special test methods or assessment methods and indicate relevant values and parameters obtained from results as appropriate and necessary for the use of the product and the design of the works or part of the works in which the product is used. Where necessary and appropriate refer to annex(es) to the ETA.*

### 2.1. Kit performances

#### 2.1.1. Safety in case of Fire - Fire resistance

Cold storage room kit assemblies have been tested in accordance with EN 1364-1, in order to be classified in accordance with EN 13501-2.

The assembly was composed of the Coldy 2 type metal framework, with 60 mm thick composite panels fixed to it. The test led to the following class: EI 45.

Taking into account Annex K of ETA-Guideline

CSR, this result applies to all composite panels with a higher thickness, both with all possible surfaces and all possible finishings covered by this ETA.

### 2.1.2. Hygiene, Health and the Environment

#### 2.1.2.1. Release of dangerous substances

The cold storage room kit and its components comply with all relevant European and national provisions<sup>6</sup> applicable for the uses for which it is brought to the market.

In addition to the specific clauses relating to dangerous substances contained in this European Technical Approval, there may be other requirements applicable to the products falling within its scope (e.g. transposed European legislation and national laws, regulations and administrative provisions). In order to meet the provisions of the EU Construction Products Directive, these requirements need also to be complied with, when and where they apply.

#### 2.1.2.2. Water vapour permeability

On the basis of the calculation method described in EN ISO 13788 and taking into account thermal bridges, inherent to the kit, the hygrothermal behaviour of the assembled kit has been determined. No substantial risks of condensation have been detected.

#### 2.1.2.3. Moisture resistance

Having examined the construction details for the kit, and using the available technical knowledge and experience from similar well-known technical solutions no substantial risk exists for significant deterioration of the kit's performance, due to deficiencies of the moisture resistance.

Therefore, the kit and its components are moisture resistant, as far as the relevant recommendations in chapter 7 of the ETA-Guideline CSR are being taken into account.

#### 2.1.2.4. Fitness for contact with food and feedstuffs

The following types can be used to store food- or feedstuff: The cold storage room kits, with PVDF coated wall and ceiling panels are intended to store food and feedstuff. The accompanying information with the CE Marking will contain the reference "F". In all other cases, the cold storage room kit may not be used to store food- or feedstuff.

---

<sup>6</sup> Known at the date of issuing.

### **2.1.2.5. Compliance to EC Directives and EEA Member States' legislation related to materials and articles intended to come into contact with foodstuffs**

The Cold Company ensures, in accordance with the declaration of conformity, CC2002-001 issued by the supplier Plastic Finishings AS of the PVDF finishing used for the production of wall, ceiling and floor panels and cold storage doors, that it complies with the provisions in force in all EEA countries concerning the contact of materials with food (implementing EC directives 11/111/EEC, 22/222/EEC, 333/333/EEC, 44/444/EEC and 555/555/EEC).

### **2.1.3. Safety in Use**

#### **2.1.3.1. Impact resistance**

##### **2.1.3.1.1. Resistance to structural damage from soft body impact load – 50 kg bag**

For wall panels: The soft body impact resistance test, related to structural damage, resulted in the following class: WIV.

For ceiling panels: The soft body impact resistance test, related to structural damage, resulted in the following class: CII.

##### **2.1.3.1.2. Resistance to structural damage from hard body impact load – 1 kg steel ball**

The hard body impact resistance test, related to structural damage, resulted in the following class: IV.

#### **2.1.3.2. Mechanical resistance**

Indication of geometrical data

This ETA provides the following information:

- the geometrical data (dimensions and cross sections, including tolerances) of the structural kit components and of the assembled kit
- the properties of the materials and constituent products used that are needed to determine, according to the National Provisions, valid in the place of use, or possible use, load-bearing capacities and other properties, including aspects of durability and serviceability, of the assembled kit installed in the works, as far as possible.

#### **2.1.3.3. Slipperiness of floor surfaces**

Tests performed on the vinyl floor covering product lead to the following class: R12.

#### **2.1.3.4. Safety against personal injuries by contact**

The geometry of the kit components does not lead

to a significant risk of abrasion.

### **2.1.3.5. Safety against collapse**

Pressure relief provisions are part of the kit (see §1.3.5.1). No substantial influence on the kits' performance with regard to the essential requirements has been detected during the assessment, which was limited to examining design details of the pressure relief provision and the ETA-holder's installation manual.

### **2.1.4. Energy Economy and Heat Retention - Air permeability**

The rate of air infiltration through the cold storage room kit is 0,7 m<sup>3</sup>/(m<sup>2</sup>.h).

### **2.1.5. Aspects of Durability, Serviceability and Identification**

#### **2.1.5.1. Durability**

##### **2.1.5.1.1. Compatibility of components used**

No incompatibilities have been detected.

##### **2.1.5.1.2. Influences from products being stored in the cold storage room on kit durability**

The nature of the products stored in the Cold storage room may have a negative influence on the durability of the kit components. The ETA-Holder should be contacted in case very aggressive substances are likely to be stored during the working life of the product.

#### **2.1.5.2. Serviceability**

##### **2.1.5.2.1. Provisions related to the kit as a whole**

###### **2.1.5.2.1.1. Resistance to functional failure from soft body impact load – 50 kg bag**

The soft body impact resistance tests, related to functional failure, lead to the following classes:

For wall panels: WIV

For ceiling panels: CII

###### **2.1.5.2.1.2. Resistance to functional failure from hard body impact load – 0.5 kg steel ball**

The hard body impact resistance tests, related to functional failure, lead to the following class: IV

### 2.1.5.2.1.3. Resistance to functional failure due to eccentric loads

The resistance to functional failure from eccentric load tests, lead to the following class: c

### 2.1.5.2.1.4. Resistance to functional failure from point loads parallel or perpendicular to the surface

The resistance to point loads tests, related to functional failure, led to a positive result.

### 2.1.5.2.1.5. Rigidity of walls and partitions to be used as a substrate for ceramic tiling

No performance has been determined.

### 2.1.5.3. Identification

The cold storage room kit has been identified in §1.

## 2.2. Composite Panels and supporting profiles performances

### 2.2.1. Safety in case of Fire - Reaction to fire

The composite panels have been tested in order to be classified in accordance with EN 13501-1.

**Table 2.1: Test results for reaction to fire classification in accordance with EN 13501-1**

Panel Description	Core thickness	Reaction to fire class
2 galvanised steel faces, PUR core, plastisol facing	100mm	C s3d0
	150mm	D s3d0
1 galvanised steel steel face (bottom), PUR core, 1 multi-layer solid wood panel (top), linoleum floor covering**	80mm	C <sub>FL</sub>
	150mm	D <sub>FL</sub>
* Tested in accordance with prEN 14509		
** Tested in accordance with ETA-Guideline 016		

**Table 2.2: Extended Application for reaction to fire classification in accordance with EN 13501-1**

Panel Description	Core thickness range	Reaction to fire class
2 galvanised steel or stainless steel faces, PUR core*	60mm < x ≤ 100mm	C s3d0
	120mm < x ≤ 150mm	D s3d0
1 galvanised steel or stainless steel face (bottom), PUR core, 1 multi-layer solid wood panel (top), linoleum floor covering**	60mm < x ≤ 80mm	C <sub>FL</sub>
	100mm < x ≤ 150mm	D <sub>FL</sub>
* Tested in accordance with prEN 14509		
** Tested in accordance with ETA-Guideline 016		

## 2.2.2. Hygiene, Health and the Environment

### 2.2.2.1. Release of dangerous substances

See §2.1.2.1.

### 2.2.2.2. Water vapour permeability

Due to the nature of the faces, the composite panels are considered to be water vapour tight.

### 2.2.2.3. Fitness for contact with food and feedstuffs

Also these panels are impervious (see §2.2.2.2), they do not absorb liquids, are not toxic (see §2.1.2.4), are smooth and are not susceptible to the growth of harmful organism (Annex H of the ETA-Guideline). The panels are washable. The assessment is based on report 123/321 from the Food Products Testing House Ltd.

### 2.2.3. Safety in Use - Mechanical resistance

#### 2.2.3.1. Kits, where the composite panels are mechanically fastened to a supporting system

In accordance with ETA-Guideline 016, it has been established, for the Coldy 2 type of kit, that the fixing resistance of the composite panels, using the fixing system, supplied by the ETA-Holder is satisfactory.

#### 2.2.3.2. Mechanical resistance of wall, ceiling and floor panels

##### 2.2.3.2.1. Tensile strength

The tensile strength perpendicular to the faces of composite panels is 50 N/m<sup>2</sup>.

##### 2.2.3.2.2. Mechanical resistance of wall panels

See Table A.1

##### 2.2.3.2.3. Mechanical resistance of ceiling panels

See Table A.2

##### 2.2.3.2.4. Mechanical strength of pre-shaped panel intersections

The kit does not contain pre-shaped panel intersections.

### 2.2.3.3. Resistance to structural damage from eccentric vertical load

The resistance to structural damage from eccentric load test lead to the following class: C

## 2.2.4. Energy Economy and Heat Retention - Thermal performance

**Table 2.3: Performances related to Energy economy and Heat Retention**

Characteristic	Verification method	Thickness (mm)	Value/level (m <sup>2</sup> .K/W)
Coldy 1 – Thermal resistance (R <sub>90/90</sub> )	prEN 14509	60	2,0
		80	2,6
		100	3,2
		120	3,8
		150	4,6
Coldy 2 - Thermal resistance (R <sub>90/90</sub> )	prEN 14509	60	1,9
		80	2,5
		100	3,1
		120	3,7
		150	4,4

## 2.2.5. Aspects of Durability, Serviceability and Identification

### 2.2.5.1. Durability

#### 2.2.5.1.1. Panels

The panels are being manufactured with pentane as blowing agent and are therefore considered to meet the requirements as set out in prEN 14509.

#### 2.2.5.1.2. Faces

The galvanised steel sheet is in conformity with EN 10326, the stainless steel sheet in conformity with EN 10088-1 and is suitable for composite panels.

#### 2.2.5.1.3. Coatings:

**Table 2.4: Durability performance of coatings**

Characteristic	Polyester (≥ 20 μm)*	Polyester (≥ 30 μm)*	Plastisol (≥ 150 μm)*	PVDF (≥ 40 μm)**
Resistance to humidity	Pass (500 h)	Pass (1000 h)	Pass (1000 h)	Pass (1000 h)
NA: Not applicable * On galvanised steel sheet ** On stainless steel sheet				

#### 2.2.5.1.4 Floor finishes

No Performance Determined.

### 2.2.5.2. Serviceability

#### 2.2.5.2.1. Provisions related to composite panels

#### 2.2.5.2.1. General serviceability aspects of composite panels

No performance determined.

#### 2.2.5.2.2. Mechanical resistance of floor panels

See Table A.3

#### 2.2.5.2.3. Performance characteristics of finishes

**Table 2.5: Serviceability performance of coatings**

Characteristic	Polyester (≥ 20 μm)*	Polyester (≥ 30 μm)*	Plastisol (≥ 150 μm)*	PVDF (≥ 40 μm)**
Adherence after bending	Pass (2T)	Pass (2T)	<b>CSTB criteria awaited</b>	Pass (2T)
Cracking after bending	Pass (T > 6)	Pass (T > 5)	Pass (T > 4)	Pass (T > 4)
Impact resistance (NM)	100	120	150	150
Resistance to staining	NA	NA	NA	Pass
Resistance to chalking	NA	NA	NA	Pass
NA: Not applicable * On galvanised steel sheet ** On stainless steel sheet				

#### 2.2.5.2.4. Floor finishes

No Performance Determined.

### 2.2.5.3. Identification

The cold storage room kit and its components have been identified in §1.

## 2.3. Doors and Windows

### 2.3.1. Safety in case of Fire

#### 2.3.1.1. Reaction to fire

Some doors have been tested in order to be classified in accordance with EN 13501-1.

**Table 2.6: Reaction to fire classification in accordance with EN 13501-1**

Door Description	Core thickness range	Reaction to fire class
Colddoor CD01		No performance determined
Colddoor CD02	60mm < x ≤ 100mm*	C s3d0
	120mm < x ≤ 150mm*	D s3d0
Colddoor CD03	60mm < x ≤ 100mm*	C s3d0
	120mm < x ≤ 150mm*	D s3d0
Colddoor CD04		No performance determined
Colddoor CD05		
* Tested thickness.		

### 2.3.1.2. Fire resistance

Both Colddoor CD02 and CD03 have been classified in accordance with EN 13501-2 and obtained the following classes:

- CD02: EI60
- CD03: EI90

### 2.3.2. Hygiene, Health and the Environment

#### 2.3.2.1. Release of dangerous substances

See §2.1.2.1.

#### 2.3.2.2. Water vapour permeability

See §2.2.2.2.

#### 2.3.2.3. Fitness for contact with food and feedstuffs

See §2.2.2.3.

### 2.3.3. Safety in Use

#### 2.3.3.1. Impact resistance

In accordance with EN 1192 the following results have been obtained:

**Table 2.7: Impact resistance performance for doors in accordance with EN 1192**

Door Description	Core thickness range	Impact resistance (Nm)
Colddoor CD01		No Performance Determined
Colddoor CD02	60mm < x ≤ 100mm	200
	120mm < x ≤ 150mm	300
Colddoor CD03	60mm < x ≤ 80mm	300
	100mm < x ≤ 150mm	400
Colddoor CD04	60mm < x ≤ 100mm	300
	120mm < x ≤ 150mm	400
Colddoor CD05	60mm < x ≤ 80mm	600
	100mm < x ≤ 150mm	600

#### 2.3.3.2. Mechanical resistance - Safety against entrapment

A safety release provision in accordance with EN 1125 is always foreseen on at least one of the doors of the supplied cold storage room kit.

The design of the door and the safety release provision ensures no detrimental effect on the kit meeting the other essential requirements.

#### 2.3.4. Energy Economy and Heat Retention - Thermal performance

**Table 2.8: Performances related to Energy economy and Heat Retention**

Characteristic	Verification method	Thickness (mm)	Value/level (m <sup>2</sup> .K/W)
Thermal resistance (R <sub>90/90</sub> )	ETA-Guideline CSR §5.3.6.1	60	1,9
		80	2,5
		100	3,1
		120	3,6
		150	4,4

#### 2.3.5. Aspects of Durability, Serviceability and Identification

##### 2.3.5.1. Durability

###### 2.3.5.1.1. Mechanical resistance

The durability of mechanical resistance for pedestrian doors shall be classified in accordance with EN 12400. For other doors EN 12605 applies.

###### 2.3.5.1.2. Performance characteristics of non-pedestrian doors

The classification of the durability of the durability of non-pedestrian doors shall be performed in

accordance with EN 12605.

### 2.3.5.2. Serviceability

#### 2.3.5.2.1. Behaviour of doors and windows placed between two different climates

The effect on doors, windows and panels with transparent surfaces, due to being placed between two different climates, both of which shall be specified by the ETA-applicant, shall be classified in accordance with EN 12219.

#### 2.3.5.2.2. Automatic opening and / or closing devices

Occasionally, this might be relevant for cold storage doors (in case of fire).

#### 2.3.5.2.3. Behaviour of doors (and windows) under repeated opening and closing

The resistance of doors (and windows) under the influence of being opened and closed repeatedly, shall be classified in accordance with prEN 13115 and prEN 12217.

#### 2.3.5.2.4. Behaviour of doors and windows under operating forces

The behaviour under operating forces of doors and windows, shall be classified in accordance with prEN 12217.

#### 2.3.5.2.5. Behaviour of doors under loads

The behaviour under loads of doors, shall be classified in accordance with EN 1192.

#### 2.3.5.2.6. Defrost provisions for doors

The presence of defrost provisions as a part of the kit shall be declared.

As the verification is done on a case-by-case basis, the verification method and the characteristics shall be declared in the ETA, as well as extended application of the test results (if any), under the responsibility of the Approval Body.

The possible influences on ER2, ER3, ER4 and ER6 of the kit shall be assessed and declared if appropriate.

#### 2.3.5.2.7. Radiation properties – Light transmittance

The light transmittance of glazings of windows and panels with transparent surfaces, shall be declared in accordance with EN 410.

#### 2.3.5.2.8. Safe opening

Applicable for vertically moving cold storage doors

Verification: EN 12604 and 12605.

### 2.3.5.2.9. Power operation

Applicable for power operated cold storage doors. Verification: EN 12453.

### 2.3.5.3. Identification

The cold storage room kit and its components have been identified in §1.

## 2.4. Fixing Systems, Sealants, Gaskets and Building Hardware

### 2.4.1. Safety in case of Fire - Reaction to fire

The fixing systems for the doors and of the Coldy 2 kit type have been tested and classified as a part of a door set (See §2.3.1) or as part of the panel assembly (See §2.2.1).

Sealants, gaskets and building hardware have been classified in accordance with EN 13501-1 (see table 2.9).

Table 2.9: Reaction to fire classification in accordance with EN 13501-1

Component	Reaction to fire class
Building Hardware	A1
EPDM rubber gaskets	E
Silicone sealant	F

### 2.4.2. Hygiene, Health and the Environment

#### 2.4.2.1. Release of dangerous substances

See §2.1.2.1.

#### 2.4.2.2. Water vapour permeability

See §2.2.2.2.

#### 2.4.2.3. Fitness for contact with food and feedstuffs

See §2.2.2.3.

### 2.4.3. Safety in Use - Fixing resistance

It has been established that hanging bars (supplied by the ETA-Holder) can be fixed against the panels, using the appropriate fixing system (supplied by the ETA-Holder), without detrimental effect on the kit's performances.

### 2.4.4. Energy Economy and Heat Retention - Thermal performance

The influence of building hardware has been taken into account in §2.4.2, the influence of the fixings for the Coldy 2 kit type has been taken into account in §2.2.4.



The  $\lambda$  value of the silicone sealant is 0,056 W/m.K.

## 2.4.5. Aspects of Durability, Serviceability and Identification

### 2.4.5.1. Durability

#### 2.4.5.1.1. Fixings - Corrosion

The fixings are made of an appropriate grade of stainless steel. No specific durability assessment has been performed.

#### 2.4.5.1.2. Sealants

The durability of sealants has been classified in accordance with ISO 11600. See §1.

#### 2.4.5.1.3. Gaskets

**Table 2.13 Durability performances of gaskets**

Characteristic	Value
Compression set (initially)	< 5,0 %
Compression set (after heat ageing)	< 5,3 %
Compression set (after compatibility conditioning)	< 5,4 %

#### 2.4.5.1.4. Building hardware

The durability of building hardware shall be classified in accordance EN 1670 (corrosion resistance).

### 2.4.5.2. Serviceability – Gaskets

**Table 2.10 Serviceability performances of gaskets**

Characteristic	Value
Compression set (initially)	< 5,0 %
Compression set (after temperature cycling)	< 5,2 %

### 2.4.5.3. Identification

The cold storage room kit and its components have been identified in §1.

## 3. Evaluation of Conformity and CE marking

### 3.1. Attestation of Conformity

*Indicate required system of conformity attestation (Annex III to CPD) as laid down by the Commission. If the ETA covers several products, the required system of conformity attestation should be indicated for each of them.*

### 3.2. Responsibilities

#### 3.2.1. Tasks of the manufacturer

##### 3.2.1.1. Factory production control

*Specify methods and extent of permanent internal control of production undertaken by the manufacturer, including type and minimum frequency of tests. If the ETA covers several products each one of them should be dealt with separately.*

##### 3.2.1.1.1. General

The ETA-holder exercises permanent internal control of the production. All the elements, requirements and provisions adopted by the ETA-holder are being documented in a systematic manner in the form of written policies and procedures. This factory production control system ensures that cold storage room kits are in conformity with the European Technical Approval (ETA).

The personnel involved in the production process have been identified, sufficiently qualified and trained to operate and maintain the production equipment. Machinery equipment is being regularly maintained and this is being documented. All processes and procedures of production are being recorded at regular intervals.

The ETA-holder maintains a traceable documentation of the production process from purchasing or delivery of raw or basic raw materials up to the storage and delivery of finished products.

The factory production control system for the cold storage room kits includes relevant design specifications, including adequate drawings and written instructions for:

- type and quality of all materials and components incorporated in the cold storage room kits
- positions of components in the cold storage room kits
- overall dimensions of cold storage room kits
- installation of components and ancillary components
- markings for correct position and installation in the works, and special handling devices, when

- relevant
- packaging and transport protection

The production control system specifies how the control measures are carried out, and at which frequencies.

Products that do not comply with requirements as specified in the ETA are being separated from the conforming products and marked as such. The ETA-holder registers non-compliant production and action(-s) taken to prevent further non-conformities. External complaints are also being documented, as well as actions taken.

### 3.2.1.1.2. In-coming material

When materials/products are delivered for incorporation into the production process, verification of conformity with specifications in the ETA takes place, with special attention for the following aspects:

- the coils are in conformity with the European product standards EN 10326 and EN 10088-1
- the wood-based panels are in conformity with EN 13986
- the insulation material is in conformity with the European product standard EN 13165
- the products that are being supplied are in conformity with the ETA-holder's specifications

### 3.2.1.1.3. Maintenance, calibration of testing equipment

All testing equipment is being maintained, calibrated and/or checked against equipment or test specimens traceable to relevant international or nationally recognised reference test specimens (standards). In case no such reference test specimens exist, the basis used for internal checks and calibration is being documented.

The ETA-holder ensures that handling, preservation and storage of test equipment is such that its accuracy and fitness for purpose is maintained. The calibration of all test equipment shall be repeated if any repair or failure occurs which could upset the calibration of the test equipment.

### 3.2.1.2. Other tasks of manufacturer (only if relevant)

*Specify other tasks for the manufacturer depending on required system of conformity attestation, e.g. initial type-testing. If the ETA covers several products each one of them should be dealt with separately.*

The tables below show the characteristics that are being checked during FPC. The results of these checks are being registered by the ETA-holder.

**Table 3.1: Properties and minimum frequencies of control – Composite panels**

Property	Test method	Number of Samples	N° of Tests
<b>Properties of the core material</b>			
Density	§5.2.7.3	3	2 / shift
Compressive strength and modulus	§5.2.7.2	3	2 / 5 shifts
Shear strength and modulus			
<b>Properties of the face material</b>			
Thickness	§5.2.7.3	3	Every delivery
Tensile strength and modulus	§5.2.7.2		
<b>Properties of the adhesives</b>			
Coverage (spread)	-	-	Continuously
Setting time, maximum open time or working life (pot life)	ISO 10364 EN 1364	-	2 / shift
<b>Properties of the panels</b>			
Dimensions	§5.2.7.3	1	2 / shift
Tensile strength	§5.2.4.2	3	
Shear strength	§5.2.7.2	1	1 / 10 shifts
Thermal performance	§5.2.6.1	1	3 / year
Air permeability	§5.2.6.2		
Water vapour permeability	§5.2.6.3		

The panel lock system is being tested in accordance with the provisions in ETA-Guideline CSR.

The ETA-holder and the notified body shall agree on which cold storage doors (or door assemblies) the tests as given in table 3.2 should be conducted.

**Table 3.2: Properties and minimum frequencies of control – Doors, windows and panels with transparent surfaces**

Characteristic	Frequency of testing
Food safety (only design aspects)	Every door
Impact resistance	1 / year
Load-bearing capacity of safety devices	1 / year
Mechanical resistance	1 / year
Power operation	1 / year
Resistance to wind load	1 / year
Resistance to wind (caused by air pressure)	1 / year
Safe opening	1 / year
Air permeability	3 / year
Identification	Every door

### 3.2.2. Tasks of approved bodies

*Specify the various tasks of approved bodies depending on required system of conformity*

attestation, including type and frequency of testing, of inspections and of surveillance, where relevant. If the ETA covers several products each one of them should be dealt with separately.

### 3.2.2.1. Initial type testing

The approval tests have been conducted by the approval body in accordance with chapter 5 of the ETA-Guideline CSR and the approval body has assessed the results of these tests in accordance with chapter 6 of this ETA-Guideline, as part of the ETA issuing procedure.

These tests shall be used for the purposes of Initial Type Testing and this work shall be validated by the approved body for Certificate of Conformity purposes.

### 3.2.2.2. Assessment of the factory production control system - initial inspection and continuous surveillance

Assessment of the factory production control system is the responsibility of the approved body.

An assessment shall be carried out of the production unit to demonstrate that the factory production control is in conformity with the ETA and any subsidiary information. This assessment shall be based on an initial inspection of the factory. The relevant production unit has been specified in the ETA.

Subsequently continuous surveillance of factory production control is necessary to ensure continuing conformity with the ETA. It is recommended that Surveillance inspections are to be conducted at least twice a year.

Note: Annex J of the ETA-Guideline CSR contains a recommended checklist for initial inspection and continuous surveillance of the FPC system.

## 3.3. CE marking


### 3.3.1. General

The CE marking shall be affixed on the accompanying commercial document. In accordance with the ETA-Guideline CSR, the required information to accompany the symbol "CE" is:

- identification number of the notified body
- name / address of the ETA-holder for the kit
- date of the marking
- number of the EC Certificate of Conformity
- number of ETA
- reference to the ETA-Guideline CSR
- indication to clarify the intended use
- designation code for relevant performance characteristics, as far as they are not specified in the ETA


Note: g) and h) will not necessarily be given in the marking itself, but on the declaration.

### 3.3.2 Example of CE-Marking

 XXXX	"CE"-symbol
Cold company Temperature Lane 273 9999 County Country XX  xxxx-CPD-xxxx	Number of Notified Body Name and address of the ETA-holder  Two last digits of year of affixing CE Marking Number of EC certificate of conformity
ETA N° XX/XXXX  ETAG XXX, Part 1 Cold storage premises kits – Part 1: Cold storage room kits Type C2-G2-100-SD02 NF/PF/F XXX	ETA Number ETAG Reference  Designation code (see §1) for relevant performance characteristics not covered by the designation code

### 3.3.3. For extension or replacement components of cold storage room kits

For components put on the market separately for incorporation into an existing assembled (previously put onto the market) cold storage room, i.e. for extension or repair of an existing cold storage room (remedial or refurbishment), the CE Marking of the component will be as follows:

 XXXX
Cold company Temperature Lane 273 9999 County Country XX  xxxx-CPD-xxxx
ETA N° XX/XXXX  ETAG XXX, Part 1 Cold storage premises kits – Part 1: Cold storage room kits  Replacement component of a cold storage room kit

**"CE"-symbol**

Number of Notified Body

Name and address of the ETA-holder

Two last digits of year of affixing CE Marking Number of EC certificate of conformity

ETA Number  
ETA Reference

Designation code (see §1) for relevant performance characteristics not covered by the designation code

**4. Assumptions under which the fitness of the product(s) for the intended use was favourably assessed**

**4.1. Manufacturing**

*Indicate special techniques of manufacture and assembly in the factory and make provisions for the qualification of the personnel and the technical installation of the manufacturing plant (for example for glued and welded constructions) in so far as is relevant for the fitness of the product(s) for the intended use when incorporated in the works and insofar as there is a relationship with the fulfilment of the essential requirements.*

*Where provisions concerning manufacturing require confidential treatment, they should not be indicated in the ETA itself but kept by the issuing approval body in the technical documentation of the ETA and only communicated to the approved bodies involved in the conformity attestation procedure in so far as is necessary for their testing, inspection and certification tasks.*

**4.2. Installation**

**4.2.1. General**

Inspection on delivery

Each panel is numbered, indicating where each panel should be used in the cold storage room. The ETA-Holder will submit a plan.

Site preparation

Before assembling the room, the substrate should be free of debris and swept clean.

Connecting panels

Connecting panels is performed from the inside. The male lock is located on the tongue edges of the panels, while the female lock is located on the groove. Access to the male lock is provided through the holes punched in the interior panel surface. The lock is activated by engaging the wrench through the hole, opening the lock arm. Ensure that the lock arm is in a complete open position before joining panels.

**4.2.2. Installation**

Floors:

Kits with floor Panels: A polyethylene sheathing should separate the floor panels and the building floor. Floor panels should be installed level, with flush edges, before panels are connected.

Floorless kits: Sweep clean and remove debris from the existing building floor.

Walls:

Starting from a rear corner panel, place the first panel even with outside of base, and partially lock it

into position. Select a wall panel on either side of the corner and firmly lock these panels to the corner, ensuring that the tops are level. Partially lock panel bottom locks into the floor pin, but do not complete locking. Proceed with panels from both directions from corner to provide stability. Panels must be locked with level top line. A corner panel must be the last panel erected.

#### Doors:

When installing entrance doors, the door should not be removed from the door jamb. Doing so will cause the spring assisted cam-lift hinge to lose the factory set tension, and the door will not operate as manufactured.

When the door section is in place, check doorjamb for proper door closing.

#### Ceiling:

The first panel should be a ceiling panel adjacent to the shortest ceiling wall. Place the end panel properly aligning it with corners, front, back, and side wall, but not walls at "open" side. Select next panel, carefully align to end panel and walls. Lock together along center seam. Engage top wall locks into ceiling and engage cam-locks, but do not fully tighten. Continue placing ceiling panels, aligning, locking and tacking to walls, until last panel is in place. After carefully checking corners and perimeter, complete locking to walls.

For a ceiling larger than 5 m long, a suspended support system is necessary.

*Specify provisions relating to the installation/assembly of product(s) on site. Give special instructions for personnel engaged in the execution and for workmanship in so far as relevant for achieving fitness of the product(s) for the intended use, when incorporated in the works. Give also parameters (design, values, etc.) and methods in so far as is needed for the design of the works or part of the works in which the product is intended to be used. Where appropriate refer to standards, ETA Guidelines or annex(es) to the ETA. Make it clear that it is the responsibility of the manufacturer of the product(s) to ensure that the information on these provisions is given to those who are concerned.*

## 5. Recommendations

### 5.1. Recommendations on packaging, transport and storage

Damage to panels can occur if not properly handled, while unloading and erecting the cold storage room. If ground is wet, stack panels on a platform to avoid contact with the ground. If panels are placed in outdoor storage, cover with moisture proof sheeting. When handling panels keep them flat to prevent denting, and avoid resting them on their corner edges. Always use sufficient manpower to eliminate mishandling or dropping panels.

*Specify provisions in so far as is relevant for achieving the fitness of the product(s) for the intended use when incorporated in the works. Make it clear that it is the responsibility of the manufacturer of the product(s) to ensure that the information on these provisions is given to those concerned.*

### 5.2. Recommendations on use, maintenance and repair

*Specify provisions relating to "operating state", maintenance, repair and warnings, in so far as is relevant for maintaining fitness of the product(s) for the intended use when incorporated in the works. Make clear that it is the responsibility of the manufacturer of the product(s) to ensure that the information on these provisions is given to those concerned.*

## **ANNEX 1 Description of product(s)**

*Drawing(s) generally describing the product(s) on one page, if appropriate (see also remark on contents of section II.1).*

## **ANNEXES 2 to n.**

*Further annexes, as appropriate, giving for example*

*Further description of the product(s) and its (their) constituents, of manufacturing details, transportation, handling, storage, installation (also drawings, if appropriate)*

*Methods for the determination of product characteristics (testing, calculation or other methods in so far as reference to ETA Guideline or standards is not possible)*

*Methods of design of part of works in which the product(s) is (are) intended to be incorporated in so far as is relevant for the fitness of the product(s) for the intended use when incorporated in the works, and where reference to ETA Guideline or standards is not possible*

*Instructions for installation/processing in so far as is relevant for the fitness of the product(s) for the intended use when incorporated in the works, and where reference to ETA Guideline or standards is not possible*

**Table A.1: Mechanical resistance of wall panels**

Characteristic	Verification method	Value/level
Thickness 60 mm and 80mm (60 mm was tested)		
Axial load-bearing capacity	ETAG CSR §5.2.4.2.2.3	1,10 kN.
Bending (or shear) strength		0,70 Mpa
Thickness 100 mm and 120 mm (100mm was tested)		
Axial load-bearing capacity	ETAG CSR §5.2.4.2.2.3	1,20 kN.
Bending (or shear) strength		0,80 Mpa
Thickness 150 mm		
Axial load-bearing capacity	ETAG CSR §5.2.4.2.2.3	1,40 kN.
Bending (or shear) strength		0,90 Mpa

**Table A.2: Mechanical resistance of ceiling panels**

Characteristic	Verification method	Value/level
<b>Thickness 60 mm</b>		
Compressive strength	ETA-Guideline CSR §5.2.4.2.2.4	0,50 Mpa
Uniformly distributed load-bearing capacity		0,60 Mpa
Walkability		A2*
<b>Thickness 80 mm and 100 mm</b>		
Compressive strength	ETA-Guideline CSR §5.2.4.2.2.4	0,40 Mpa
Uniformly distributed load-bearing capacity		0,80 Mpa
Walkability		A3*
<b>Thickness 120 mm and 150 mm</b>		
Compressive strength	ETA-Guideline CSR §5.2.4.2.2.4	0,35 Mpa
Uniformly distributed load-bearing capacity		0,90 MPa
Walkability		A4*
* Use categories: See ETA-Guideline CSR		

**Table A.3: Mechanical resistance of floor panels**

Characteristic	Verification method	Value/level
<b>Thickness: 60mm and 80 mm (60 mm was used in the test)</b>		
Compressive strength	EN 826	0,25 MPa.
Uniformly distributed load-bearing capacity	prEN 14509, Annex ...	0,30 MPa
Concentrated load-bearing capacity	ETA-Guideline CSR, §5.2.4.2.2.2	0,50 MPa.
Resistance to rolling loads	ETA-Guideline CSR, Annex I	Level 1*
<b>Thickness: 100 mm</b>		
Compressive strength	EN 826	0,30 MPa.
Uniformly distributed load-bearing capacity	prEN 14509, Annex ...	0,30 MPa
Concentrated load-bearing capacity	ETA-Guideline CSR, §5.2.4.2.2.2	0,60 MPa.
Resistance to rolling loads	ETA-Guideline CSR, Annex I	Level 2*
<b>Thickness: 120 mm</b>		
Compressive strength	EN 826	0,40 MPa.
Uniformly distributed load-bearing capacity	prEN 14509, Annex ...	0,40 MPa
Concentrated load-bearing capacity	ETA-Guideline CSR, §5.2.4.2.2.2	0,70 MPa.
Resistance to rolling loads	ETA-Guideline CSR, Annex I	Level 3*
<b>Thickness: 150 mm</b>		
Compressive strength	EN 826	0,50 MPa.
Uniformly distributed load-bearing capacity	prEN 14509, Annex ...	0,50 MPa
Concentrated load-bearing capacity	ETA-Guideline CSR, §5.2.4.2.2.2	0,80 MPa.
Resistance to rolling loads	ETA-Guideline CSR, Annex I	Level 4*
* Classification: See ETA-Guideline CSR		





**ANNEX M**  
**EXAMPLE CE CERTIFICATE**

This example CE Certificate is based on EC Guidance Paper D and the guidance from the GNB-AG, but made specific for use with Cold storage room kits.

Logo of the notified  
Certification body



Name and address of the certification body

## **EC CERTIFICATE OF CONFORMITY**

**XXXX - CPD - YYYY**

In compliance with the Directive 89/106/EEC of the Council of European Communities of 21 December 1988 on the approximation of laws, regulations and administrative provisions of the Member States relating to the construction products (Construction Products Directive - CPD), amended by the Directive 93/68/EEC of the Council of European Communities of 22 July 1993, it has been stated that the cold storage room kits

### **<PRODUCT>**

**<Name of the producer or its authorised representative>**

**<Full address>**

**and produced in the factory**

**<Factory><sup>7</sup>**

is submitted by the kit manufacturer to a factory production control and to the further testing of samples taken at the factory in accordance with a prescribed test plan and that the approved body - *<Name of the certification body>* - has performed<sup>8</sup> the initial type-testing for the relevant characteristics of the product, the initial inspection of the factory and of the factory production control and performs the continuous surveillance, assessment and approval of the factory production control, incl. checking of EC Declarations of conformity issued.

This certificate attests that all provisions concerning the attestation of conformity and the performances described in

**<ETA UV/WXYZ>**

were applied and that these cold storage room kits fulfill all the prescribed requirements.

This certificate was first issued on *<date>* and remains valid as long as the conditions laid down in the harmonised technical specification in reference or the manufacturing conditions in the factory or the FPC itself are not modified significantly and latest on *<date>*<sup>9</sup>.

*<City, Date>* *<Authorized signature>*

*<Title, Position>*

<sup>7</sup> The factory referred to is the kit factory. This may be replaced by a code, the explanation of which is retained by the notified certification body.

<sup>8</sup> In the framework of ETAs, this may be "validated" for most performance characteristics

<sup>9</sup> It is not necessary to introduce a date here.

## **ANNEX N**

### **EXAMPLE EC DECLARATION OF CONFORMITY**

The kit manufacturer, or his authorised representative established in the EEA, is responsible for the attestation of conformity of the cold storage room kit. The kit manufacturer's declaration will be on the basis of tasks carried out under his responsibility and of tasks carried out by a notified body. The declaration of the kit manufacturer must incorporate a certificate of conformity covering those aspects that are under the responsibility of the relevant notified body.

Because most kit manufacturers will deliver cold storage room kits that contain varying components, and also varying performance characteristics, the CE Marking and the EC Declaration of conformity will be different in almost each case.


For cold storage room kits, the CE Marking and the EC Declaration of conformity will be combined in one document.

This example CE Certificate is based on EC Guidance Paper D, but made specific for use with Cold storage room kits.

Logo of the cold  
storage room kit  
manufacturer

## CE Declaration of conformity

N° *[Manufacturer's internal numbering system]*


Number of Notified Body
Name and address of the kit manufacturer <sup>10</sup>
Two last digits of year of affixing CE Marking
Number of EC certificate of conformity
ETA Number ETAG Reference

### 1. Description of the product:

This cold storage room kit is designated as follows:

**Type C2-G2-100-CD02**  
**F**

**2. Provisions to which the product conforms and particular conditions applicable to the use of the product:** See ETA *[ETA Number, information regarding the kit's performance that cannot be directly derived from the ETA on the basis of the information provided in §1 should be added.]*

### 3. Name and address of the approved body:

The following approved body issued the above mentioned EC Certificate:

Name and position of signatory:

Signature:

Date :

<sup>10</sup> or his authorised representative established in the EEA